

Load Feeders and Motor Starters for Use in the Control Cabinet

**Price groups**

PG 14O, 255, 41B, 41D, 41E, 41L,
42C, 42D, 42F, 42G

8/2

Introduction**SIRIUS 3RA2 load feeders**

8/4 General data

3RA21 direct-on-line starters

8/21 - For standard mounting rails or
for screw fixing

8/29 - For 60 mm busbars

3RA22 reversing starters

8/33 - For standard mounting rails or
for screw fixing

8/39 - For 60 mm busbars

8/44 Accessories

8/55 3RV29 infeed system for load feeders

SIRIUS 3RA6 compact starters

8/56 General data

3RA61, 3RA62 compact starters

8/66 - 3RA61 direct-on-line starters

8/67 - 3RA62 reversing starters

3RA64, 3RA65 compact starters
for IO-Link

8/68 - 3RA64 direct-on-line starters

8/69 - 3RA65 reversing starters

8/70 Accessories

8/76 Add-on modules for AS-Interface

8/78 Infeed system for 3RA6

8/85 **SIRIUS 3RM1 motor starters**8/95 **ET 200SP motor starters *NEW***

Load Feeders and Motor Starters for Use in the Control Cabinet

Introduction

Overview

Central and compact starter solutions

Our range offers you many different possibilities for simple and practical starter solutions in the control cabinet. Features common to all our load feeders, compact starters and motor starters: Like all SIRIUS devices they are optimally coordinated with each

other, have a very compact design and are particularly easy and quick to install and wire up.

In addition there is a seamless range of SIRIUS 3RW soft starters available for soft starting in the control cabinet (see page 6/2).



Type	Page
------	------

SIRIUS 3RA2 load feeders

- The 3RA2 fuseless load feeders consist of the 3RV2 motor starter protector and the 3RT2 contactor. The motor starter protector and contactor are prewired and mechanically and electrically connected in preassembled assembly kits (link modules, wiring kits and standard mounting rail or busbar adapters).
- 4 sizes (S00, S0, S2, S3)
- Can be supplied for direct-on-line start or reversing duty as
 - a complete unit or
 - single devices for self-assembly
- Can be supplied with screw or spring-loaded terminals

3RA21 direct-on-line starters for snapping onto standard mounting rails or for screw fixing

- Rated control supply voltage 50/60 Hz 230 V AC and 24 V DC

3RA21

8/21

3RA21 direct-on-line starters for 60 mm busbars

- Rated control supply voltage 50/60 Hz 230 V AC and 24 V DC

3RA21

8/29

3RA22 reversing starters for snapping onto standard mounting rails or for screw fixing

- Rated control supply voltage 50/60 Hz 230 V AC and 24 V DC

3RA22

8/33

3RA22 reversing starters for 60 mm busbars

- Rated control supply voltage 50/60 Hz 230 V AC and 24 V DC

3RA22

8/39

Accessories for 3RA2 direct-on-line and reversing starters

8/44

Infeed system

- The infeed system is a convenient means of energy supply and distribution for a group of several motor starter protectors or complete load feeders with screw or spring-loaded terminals up to size S0.

3RV29

7/62,
8/55

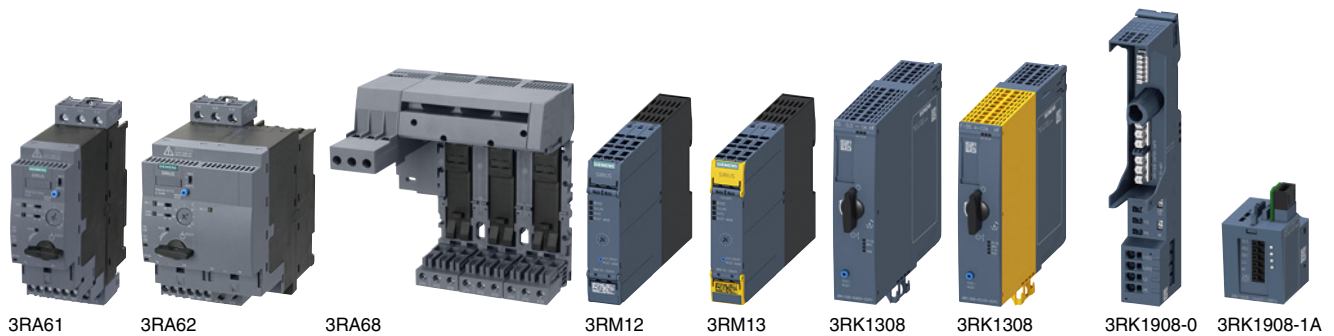

	Type	Page
SIRIUS 3RA6 compact starters		
		<ul style="list-style-type: none"> Integrated functionality of a motor starter protector, contactor and electronic overload relay and various functions of optional mountable accessories Can be used for direct starting of standard three-phase motors up to 32 A
3RA61 direct-on-line starters	3RA61	8/66
3RA62 reversing starters	3RA62	8/67
3RA64 direct-on-line starters for IO-Link	3RA64	8/68
3RA65 reversing starters for IO-Link	3RA65	8/69
Accessories for 3RA6 direct-on-line and reversing starters	3RA69	8/70
Add-on modules for AS-Interface	3RA69	8/76
Infeed system for 3RA6	3RA68	8/78
		<ul style="list-style-type: none"> Modular expandability, up to 100 A, terminals up to 70 mm² Three-phase infeeds and expansion modules Expansion modules Accessories for infeed systems for 3RA6
		8/81
		8/82
		8/83
SIRIUS 3RM1 motor starters		
		<ul style="list-style-type: none"> For switching three-phase motors up to 3 kW (at 400 V) and resistive loads up to 10 A at AC voltages up to 500 V under normal operating conditions Space-saving design (width 22.5 mm)
3RM10 direct-on-line starters	3RM10	8/91
3RM12 reversing starters	3RM12	8/91
3RM11 Failsafe direct-on-line starters	3RM11	8/91
3RM13 Failsafe reversing starters	3RM13	8/91
Accessories for 3RM1 motor starters	3RM19	8/92
	3RM19	8/89
	8US1	8/92
	8US1922	8/93
	3ZY1212	8/93
	3ZY11	8/94
	3ZY1	8/94
ET 200SP motor starters		
		<ul style="list-style-type: none"> In hybrid technology in the SIMATIC ET 200SP I/O system For the switching and protection of three-phase asynchronous motors, single-phase AC motors and single-phase asynchronous motors up to 5.5 kW (at 400 V)
3RK1308 direct-on-line starters	3RK1308-0A.0	8/102
3RK1308 reversing starters	3RK1308-0B.0	8/102
3RK1308 fail-safe direct-on-line starters	3RK1308-0C.0	8/102
3RK1308 fail-safe reversing starters	3RK1308-0D.0	8/102
BaseUnits	3RK1908-0AP00	8/103
3DI/LC control module	3RK1908-1AA00	8/103
Accessories	3RK19, 3RW49	8/104
		<ul style="list-style-type: none"> Cover for BaseUnit and infeed bus, additional mechanical bracket, fan

Load Feeders and Motor Starters for Use in the Control Cabinet

SIRIUS 3RA2 Load Feeders

General data

Overview

3RA2 load feeders

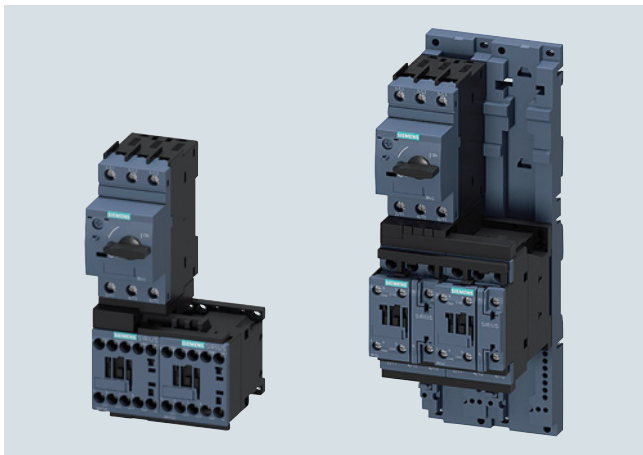

3RA22 reversing starters for snapping onto standard mounting rails or for screw fixing with screw terminals

The 3RA2 fuseless load feeders consist of the 3RV2 motor starter protector and the 3RT2 electromechanical contactor. The devices are electrically and mechanically connected using preassembled assembly kits (link modules, wiring kits and standard mounting rail or busbar adapters).

Around 500 preassembled 3RA2 combinations can be ordered for direct-on-line and reversing starting of standard three-phase motors up to 65 A (approx. 37 kW/400 V). Preassembled assembly kits are available as accessories for the power range up to 45 kW. The desired fuseless load feeder can thus be assembled quickly and economically by the customer. A time saving is also achieved in connection with switchgear acceptances, as – unlike with conventional wiring systems – there is no need to rectify possible wiring errors.

In the 3RA2 load feeder, the 3RV2 motor starter protector is responsible for overload and short-circuit protection. Back-up protective devices, such as melting fuses or limiters, are superfluous here, as the motor starter protector is short-circuit proof up to 150 kA at 400 V.

The 3RT2 contactor is particularly suitable for extremely complex switching tasks requiring the greatest endurance.

The 3RA2 load feeders are available with setting ranges from 0.14 to 65 A in sizes S00, S0 and S2. Load feeders in size S3 up to 100 A are available for self-assembly.

Size	Width Direct-on-line starters/ reversing starters	Max. rated current $I_{n \max}$	For three-phase motors up to
	mm	A	kW
S00	45/90	16	7.5
S0	45/90	32	15
S2	55/120	65	37
S3	70/150	100	45

The size of the 3RA2 load feeders is based on the size of the contactor:

Size 3RA2	S00	S0	S2	S3
Size of 3RV2 motor starter protector	S00	S00 ¹⁾ , S0	S2	S3
Size of 3RT2 contactor	S00	S0	S2	S3

¹⁾ The combination of an S00 motor starter protector with an S0 contactor is possible only for screw terminal versions.

More information

Industry Mall, see www.siemens.com/product?3RA2
 Online configurator, see www.siemens.com/sirius/configurators
 TIA Selection Tool Cloud (TST Cloud), see <https://www.siemens.com/tstcloud/?node=LoadFeeder>

Operating conditions

3RA2 load feeders are climate-proof. They are intended for use in enclosed rooms in which no severe operating conditions (such as dust, caustic vapors, hazardous gases) prevail. Suitable covers must be provided for installation in dusty and damp locations.

Behavior in the event of short circuit

EN 60947-4-1 (VDE 0660 Part 102) and IEC 60947-4-1 make a distinction between two different types of coordination, which are referred to as type of coordination "1" and type of coordination "2". Any short circuits that occur are cleared safely by both types of coordination. The only differences concern the extent of the damage caused to the device by a short circuit.

ToC
1

Type of coordination "1"

The load feeder may be non-operational after a short circuit has been cleared. Damage to the contactor or to the overload release is permissible.

ToC
2

Type of coordination "2"

There must be no damage to the overload release or to any other component after a short circuit has been cleared. The load feeder can resume operation without needing to be renewed. At most, welding of the contactor contacts is permissible if they can be disconnected easily without any significant deformation.

The types of coordination are indicated in the corresponding tables by the symbols shown on orange backgrounds.

Tripping times

All 3RA2 load feeders described here are designed for normal starting, in other words for overload tripping times of less than 10 s (CLASS 10). At rated-load operating temperature the tripping times are shorter, depending on the particular equipment and the setting range. The exact values can be derived from the tripping characteristics of the motor starter protectors.

Load Feeders and Motor Starters for Use in the Control Cabinet

SIRIUS 3RA2 Load Feeders

General data

Connection methods

For all 3RA2 feeders up to 32 A, spring-loaded terminals are available as well as screw terminals. To connect two devices with spring-loaded terminals, there are plug-in connection modules for sizes S00 and S0 which enable very quick mounting of the feeders and a vibration-resistant assembly.

To connect a motor starter protector with screw terminals to a contactor with spring-loaded terminals there are special hybrid connection modules for the sizes S00 and S0.



Screw terminals



Spring-loaded terminals

The terminals are indicated in the corresponding tables by the symbols shown on orange backgrounds.

Use of load feeders in conjunction with IE3/IE4 motors

Note:

For the use of SIRIUS 3RA2 load feeders in conjunction with highly energy-efficient IE3/IE4 motors, please observe the information on dimensioning and configuring, [see Application Manual](#).

For more information, [see page 1/7](#).

3RA2 complete units

The 3RA2 fuseless load feeders can be ordered as preassembled complete units for direct-on-line starting (3RA21) or for reversing duty (3RA22) with screw or spring-loaded terminals. From size S2, complete units for direct-on-line starting (3RA21) are only available with screw terminals.

There are control supply voltages available of 50 Hz 230 V AC and 24 V DC.

A distinction is also drawn between whether the feeder is mounted onto a 35 mm standard mounting rail, on a flat surface using screws, or on a 60 mm busbar system.

3RA21 load feeders in the size S0 must be configured on standard mounting rail adapters if high vibration and shock loads (railways, power generation,...) are involved.

A vibration and shock kit is available for mounting on busbar adapters.

Accessories

As the 3RA2 fuseless load feeders are constructed from 3RV2 motor starter protectors and 3RT2 contactors, the same accessories – such as auxiliary switches, undervoltage releases or door-coupling rotary operating mechanisms – can be used for the 3RA2 fuseless load feeders as for these motor starter protectors and contactors.

In particular, certain accessories have been optimized for the fuseless load feeders. These include the top-connected, transverse auxiliary switch on the motor starter protector, which is available in a range of different versions. Special auxiliary switches that can be snapped on from below are available for the contactor. These two accessories enable the fuseless load feeders to be wired simply without having to route cables through the device.

Incoming power supply

In total, four different energy supply options are available ([see "3RV29 infeed system for load feeders" on page 8/55](#)).

Customer assembly of fuseless load feeders

Whereas preassembled 3RA2s can be ordered up to 65 A, combinations in size S3 up to 100 A (approx. 45 kW/400 V) can be self-assembled.

The standard devices can be combined optimally – in terms of both technical specifications and dimensions, thanks to the modular system of the SIRIUS series.

The fuseless load feeders can thus be assembled easily by the customer. It is simply necessary to assemble the standard 3RV2 motor starter protector, the 3RT2 contactor and the appropriate assembly kit.

For single devices and assembly kits, [see the "Selection and ordering data" for 3RA21 direct-on-line starters and 3RA22 reversing starters, page 8/21 or 8/33 onwards](#).

For assembly kits for direct-on-line starting or reversing duty for mounting onto standard mounting rails or busbars, [see page 8/49](#).

For size S3 direct-on-line starters and sizes S0, S2 and S3 reversing starters, it is imperative that a standard mounting rail adapter is used to ensure the necessary mechanical strength. If a busbar adapter is used (not possible for size S3) then a standard mounting rail adapter is not necessary.

SENTRON 3VA circuit breakers and SIRIUS 3RT contactors are available for rated currents >100 A.

Special equipment for customer assembly can be ordered if other rated control supply voltages are required. Assembly kits can be used to facilitate assembly.

Customers can also assemble tested combinations of motor starter protectors with solid-state controls (soft starters, solid-state contactors) and load feeders with additional monitoring and control devices (3RR monitoring relays, SIMOCODE 3UF).

For the electrical and mechanical connection of protection equipment and controls there are preassembled assembly kits (link modules, wiring kits and standard mounting rail or busbar adapters).

The following types of configuration are possible:

- Direct-on-line/reversing starting
- Star-delta (wye-delta) starting
- Solid-state/soft starting

For more information and assignment tables for combinations of the 3RA2 generation for self-assembly, [see](#)

- [Configuration Manual for load feeders – SIRIUS Modular System](https://support.industry.siemens.com/cs/ww/en/view/39714188), <https://support.industry.siemens.com/cs/ww/en/view/39714188>
- [Equipment Manual](https://support.industry.siemens.com/cs/ww/en/view/60284351), <https://support.industry.siemens.com/cs/ww/en/view/60284351>

Customer assembly of fused load feeders

The flexible, modular system of SIRIUS also enables the configuration of fused load feeders up to 100 A (approx. 45 kW/400 V). Up to 32 A is also available for 45 mm installation widths.

Compact 3NW7...-1 cylindrical fuse holders for IEC fuses size 10 x 38 mm, or 3NW7...-1HG holders for Class CC UL fuses, can be used for this purpose.

For more information about fuse systems, [see Catalog LV 10](#).

Load Feeders and Motor Starters for Use in the Control Cabinet

SIRIUS 3RA2 Load Feeders

General data

Communications integration using IO-Link

Load feeders can also be assembled with IO-Link for connection to the higher-level control system. For each feeder, this requires a contactor with a voltage tap onto which a 3RA2711 function module is plugged (various versions for direct-on-line, reversing and wye-delta starters). The design of the SIRIUS load feeders permits a group of up to four SIRIUS controls to be conveniently connected through the standardized open system IO-Link to a control system, thus reducing wiring considerably compared to the conventional parallel wiring method. The electrical connection is made using only three standard cables.

The function modules perform not only the communication (contactor operation and feedback, ready signal) but also the electrical interlocking (for reversing and wye-delta starters) and the timing relay function (wye-delta reversing time).

Communication information and control supply voltages are passed on through ribbon cables so that the complete control current wiring on the feeder is no longer needed.

The monitoring and maintenance of a plant is made considerably easier by transmitting diverse diagnostics data from the function modules (e.g. missing main and auxiliary voltage, local disconnection...) through IO-Link to the higher-level control system. Also, feeders equipped for IO-Link can be conveniently controlled from the control cabinet door using the optional operator panel.

More information:

- For IO-Link, [see page 2/93 onwards](#)
- For 3RA27 function modules, [see pages 3/79, 3/86 and 3/106](#)

Communications integration via AS-Interface

Connection of the load feeders to the higher-level control system is possible not only through IO-Link but also through AS-Interface. The AS-Interface connection is recommended wherever load feeders are used in distributed applications. In this case, too, a contactor with a voltage tap is required with a corresponding 3RA2712 function module (various versions for direct-on-line, reversing and wye-delta starters). The devices are implemented in A/B technology, making it easy to connect up to 62 feeders to an AS-i master (regardless of whether they are direct-on-line, reversing or wye-delta starters). This results in a significant reduction of wiring compared to the conventional parallel wiring method. The electrical connection is made using standard cables.

The function modules perform not only the communication (contactor operation and feedback, ready signal) but also the electrical interlocking (for reversing and wye-delta starters) and the timing relay function (wye-delta reversing time).

Communication information and control supply voltages are passed on through ribbon cables so that the complete control current wiring on the starter is no longer needed.

More information:

- For AS-Interface, [see page 2/18 onwards](#)
- For 3RA27 function modules, [see pages 3/79, 3/86 and 3/106](#)

Contactors with voltage tap

For configuring load feeders with communication interfaces (AS-i/IO-Link), contactors with voltage taps are required. These contactors are not included as standard in the preassembled 3RA2 load feeders. A load feeder with communication interface must be assembled therefore from single devices.

Complete integration in the automation landscape

As the result of the communication connection through IO-Link or AS-i, the SIRIUS load feeders are fully integrated in the automation landscape and can draw on all the advantages of TIA (e.g. integration in the TIA Maintenance Station).

Mounting

3RA2 fuseless load feeders can be supplied:

- For assembly on TH 35 standard mounting rails according to EN 60715 (depth 15 mm)
- For assembly on busbar adapters (busbar center-to-center clearance 60 mm, busbar thickness 5 to 10 mm with beveled edges)

The fuseless load feeders are also suitable for screw fixing using two 3RV2928-0B push-in lugs.

3RA2 fuseless load feeders can also be installed using the 3RV29 infeed system (S0 and S00 only, [see page 7/62](#)).

Load Feeders and Motor Starters for Use in the Control Cabinet

SIRIUS 3RA2 Load Feeders

General data

Direct-on-line starting • For standard rail mounting or screw fixing • Sizes S00 and S0

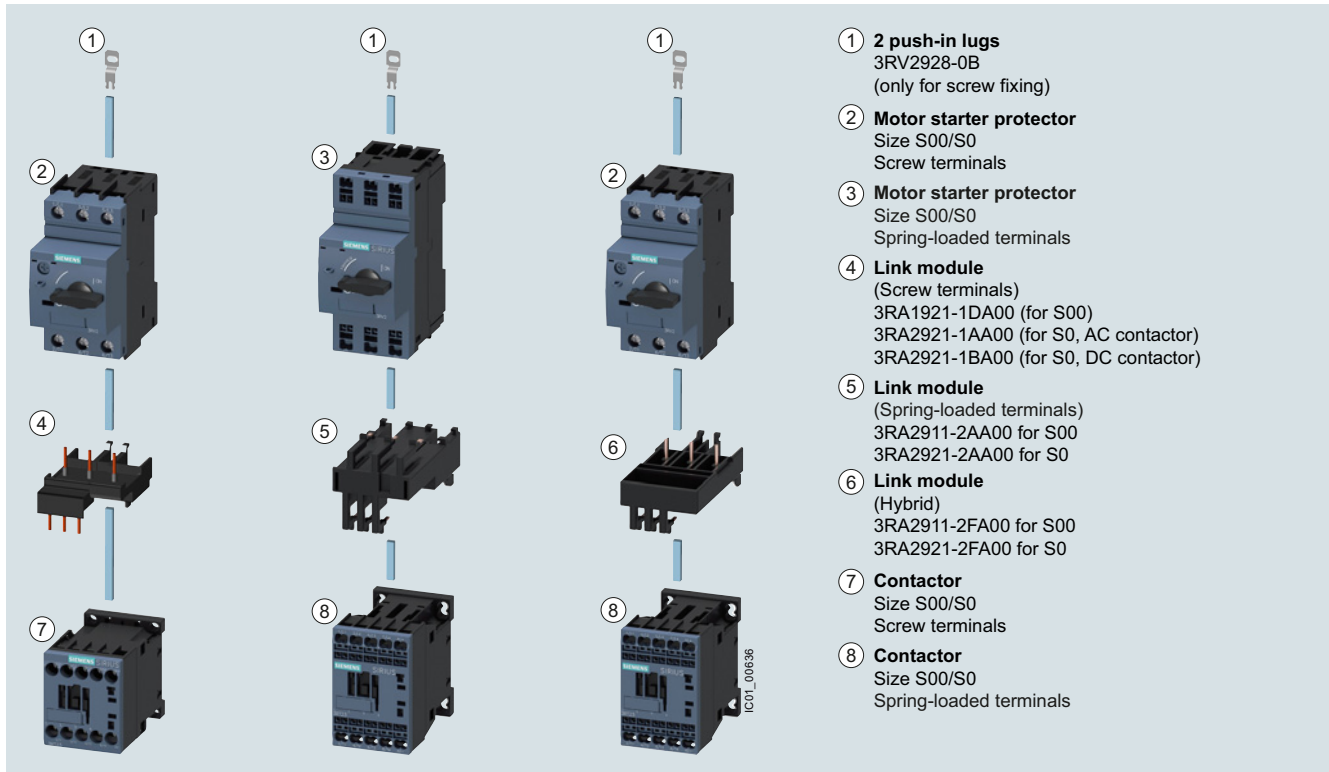

Left: 3RA21 load feeder with screw terminals

Center: 3RA21 load feeder with spring-loaded terminals

Right: Motor starter protector combination with screw terminals, with contactor with spring-loaded terminals

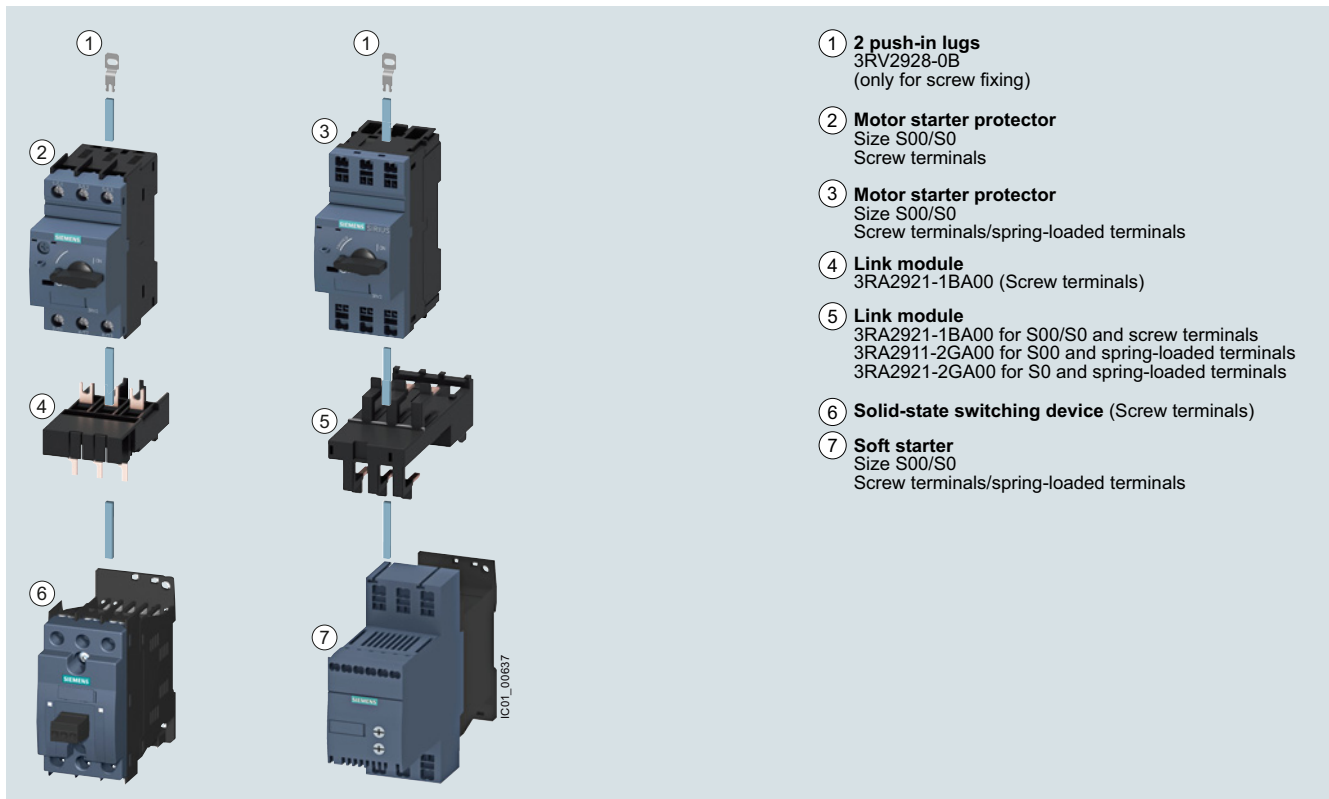

Left: Motor starter protector combination with solid-state switching device with screw terminals

Right: Motor starter protector combination with soft starter with spring-loaded terminals

Load Feeders and Motor Starters for Use in the Control Cabinet

SIRIUS 3RA2 Load Feeders

General data

Direct-on-line starting • For standard rail mounting • Size S2

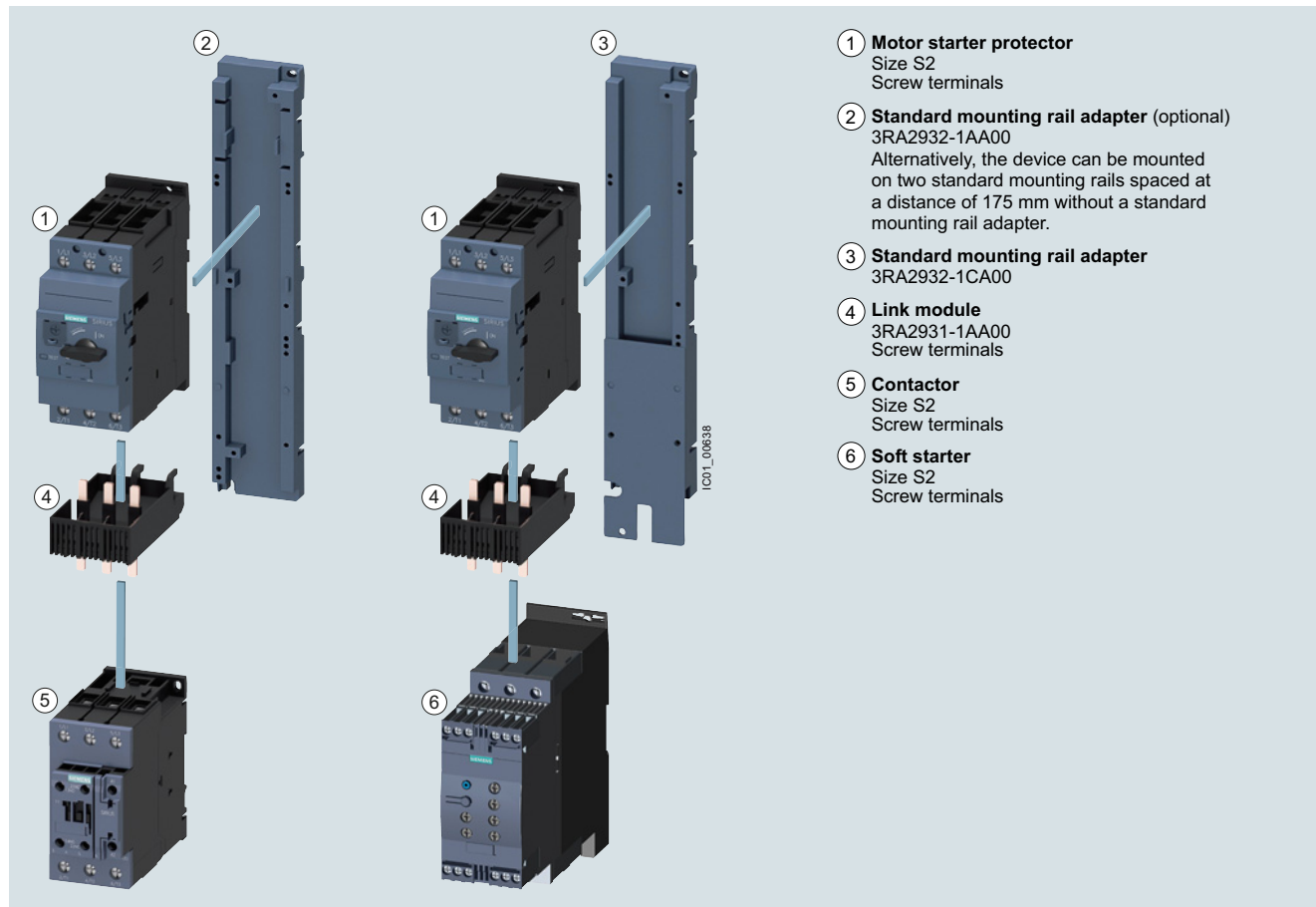

Left: 3RA21 load feeder with screw terminals

Right: Motor starter protector combination with soft starter with screw terminals

Load Feeders and Motor Starters for Use in the Control Cabinet

SIRIUS 3RA2 Load Feeders

General data

Direct-on-line starting • For standard rail mounting • Size S3

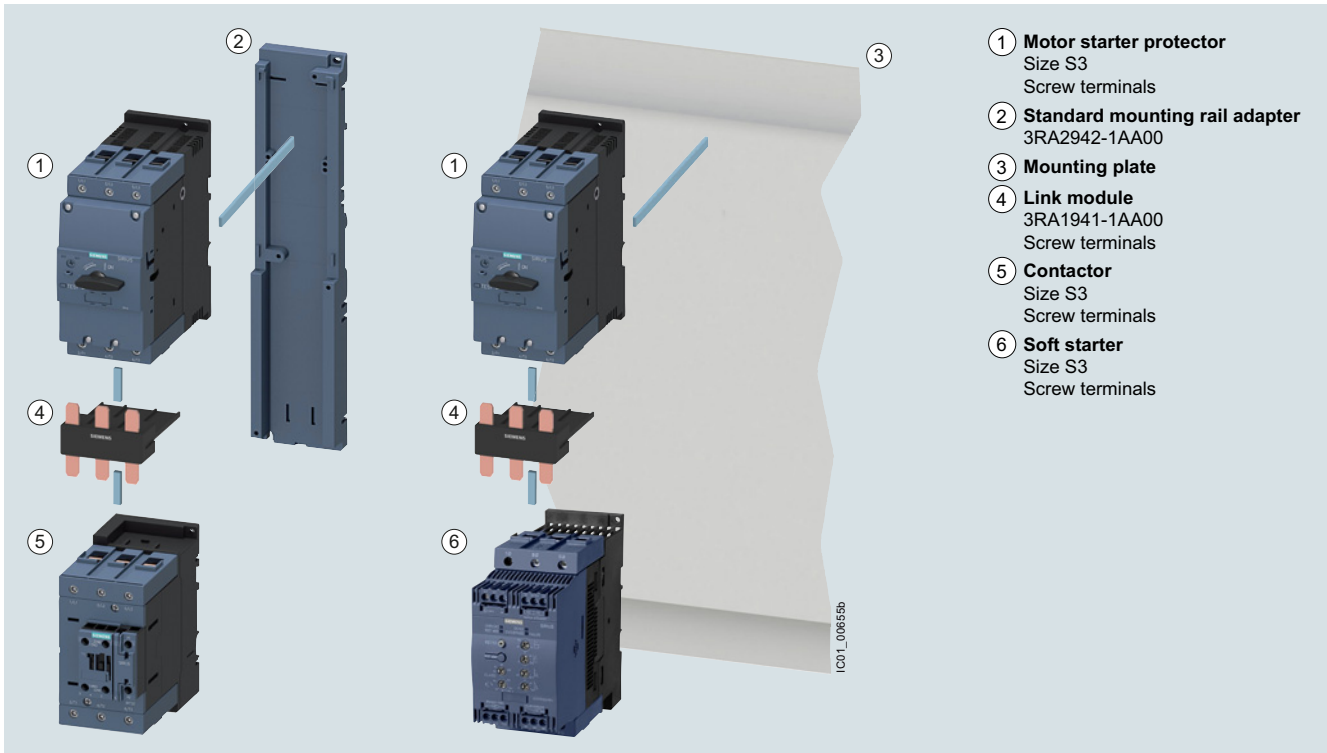

3RA21 load feeder for direct-on-line starting and standard rail mounting in size S3 (the version with screw terminals is shown in the picture)

Direct-on-line starting • For 60 mm busbar systems • Sizes S00 and S0

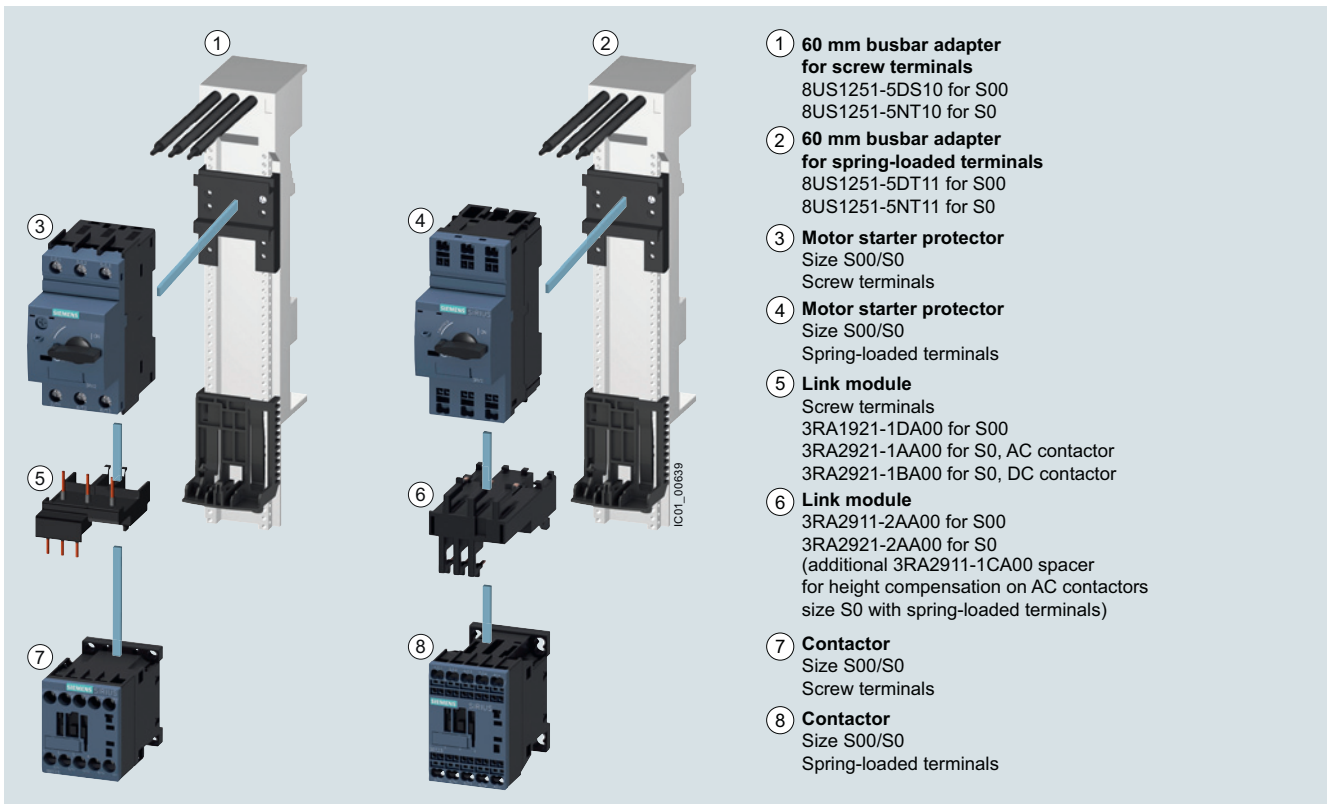

Left: 3RA21 load feeder for direct-on-line starting with busbar adapter with screw terminals

Right: 3RA21 load feeder for direct-on-line starting with busbar adapter with spring-loaded terminals

Load Feeders and Motor Starters for Use in the Control Cabinet

SIRIUS 3RA2 Load Feeders

General data

Direct-on-line starting • For 60 mm busbar systems • Size S2

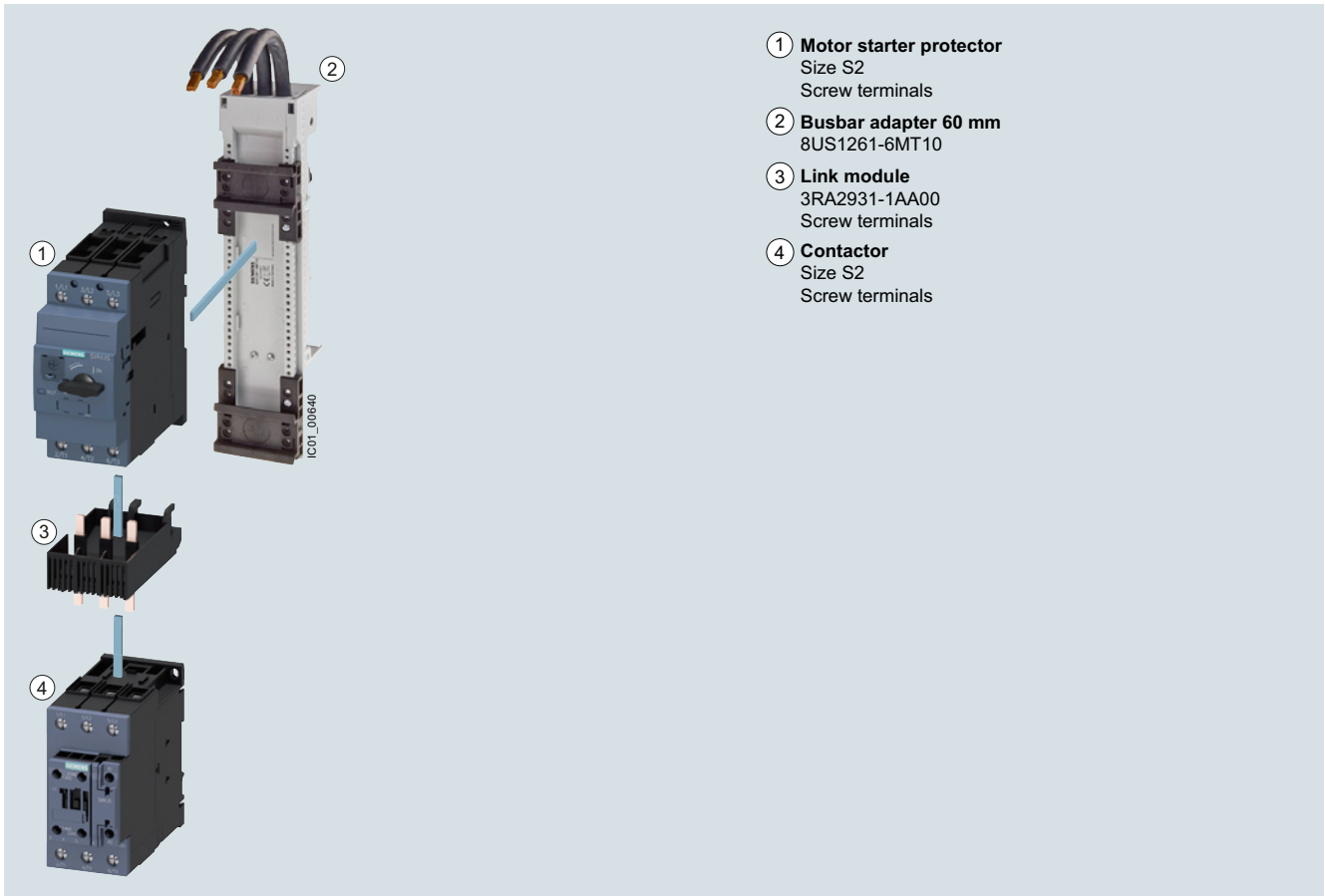

3RA21 load feeder for direct-on-line starting with busbar adapter with screw terminals

Load Feeders and Motor Starters for Use in the Control Cabinet

SIRIUS 3RA2 Load Feeders

General data

Reversing duty • For standard rail mounting or screw fixing • Size S00

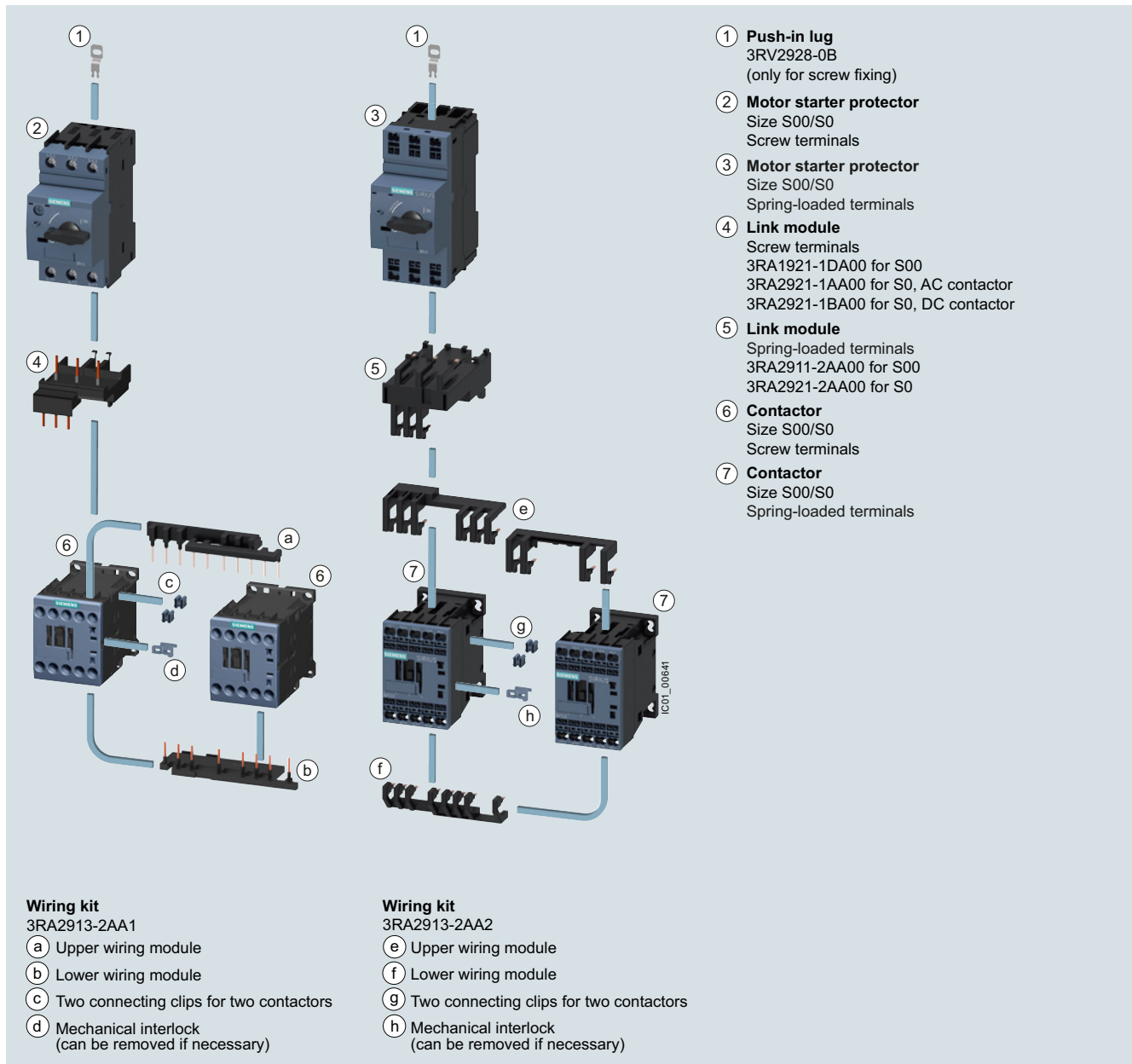

Left: 3RA22 load feeder with screw terminals with push-in lugs with two contactors for reversing duty and 3RA2913-2AA1 wiring kit for connection of the contactors (incl. mechanical interlocking and connecting clips)

Right: 3RA22 load feeder with spring-loaded terminals with push-in lugs with two contactors for reversing duty and 3RA2913-2AA2 wiring kit (incl. mechanical interlocking and connecting clips)

Load Feeders and Motor Starters for Use in the Control Cabinet

SIRIUS 3RA2 Load Feeders

General data

Reversing duty • For standard rail mounting • Size S0

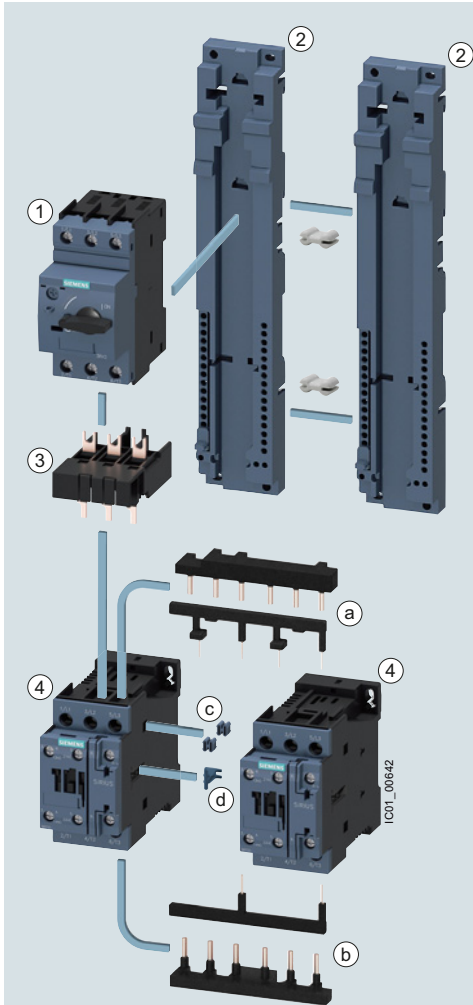

RH assembly kit for reversing duty and standard rail mounting in size S0

Screw terminals
3RA2923-1BB1

Spring-loaded terminals
3RA2923-1BB2¹⁾

Comprising:

- Wiring kit for the main and auxiliary circuits
- Two standard mounting rail adapters
- Two connecting wedges
- Mechanical interlock
- Two connecting clips
- Fixing accessories

- ① **Motor starter protector**
Size S0
Screw terminals/spring-loaded terminals
- ② **Standard mounting rail adapters**
3RA2922-1AA00
with two connecting wedges
8US1998-1AA00
- ③ **Link module**
Screw terminals
3RA2921-1AA00 for S0, AC contactor
3RA2921-1BA00 for S0, DC contactor
Spring-loaded terminals
3RA2921-2AA00²⁾
- ④ **Contactor**
Size S0
Screw terminals/spring-loaded terminals

Wiring kit

Screw terminals
3RA2923-2AA1

Spring-loaded terminals
3RA2923-2AA2

- (a) Upper wiring module
- (b) Lower wiring module
- (c) Two connecting clips for two contactors
- (d) Mechanical interlock
(can be removed if necessary)

¹⁾Contains two 3RA2911-1CA00 spacers for height compensation on AC contactors size S0 with spring-loaded terminals.

²⁾Additionally two 3RA2911-1CA00 spacers for height compensation on AC contactors size S0 with spring-loaded terminals.

3RA22 load feeder for reversing duty and standard rail mounting in size S0 (the version with screw terminals is shown in the picture)

RH assembly kits for reversing duty and standard rail mounting in size S0, [see page 8/51](#).

Load Feeders and Motor Starters for Use in the Control Cabinet

SIRIUS 3RA2 Load Feeders

General data

Reversing duty • For standard rail mounting • Size S2

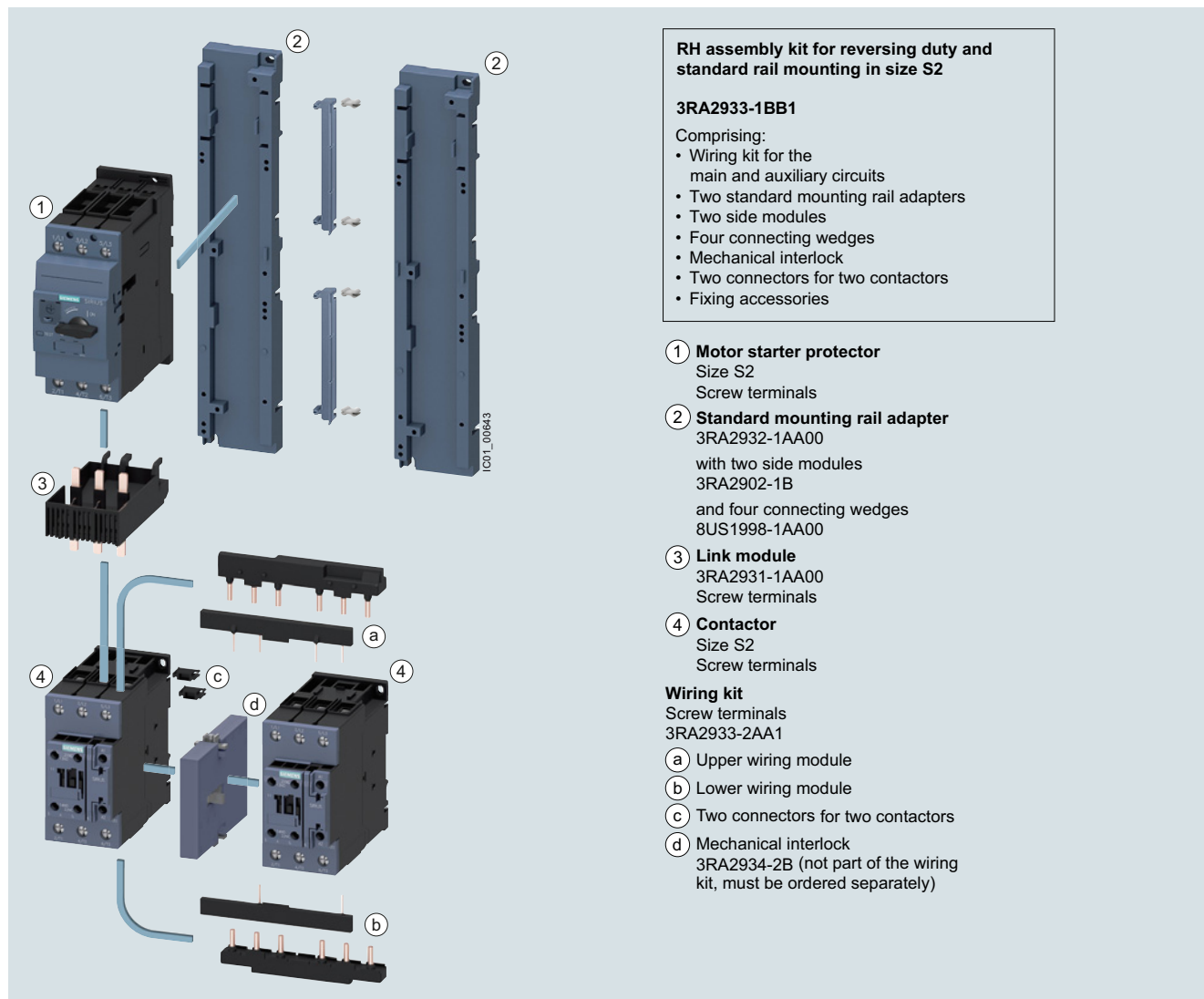

RH assembly kit for reversing duty and standard rail mounting in size S2

3RA2933-1BB1

Comprising:

- Wiring kit for the main and auxiliary circuits
- Two standard mounting rail adapters
- Two side modules
- Four connecting wedges
- Mechanical interlock
- Two connectors for two contactors
- Fixing accessories

1 Motor starter protector

Size S2
Screw terminals

2 Standard mounting rail adapter

3RA2932-1AA00
with two side modules
3RA2902-1B
and four connecting wedges
8US1998-1AA00

3 Link module

3RA2931-1AA00
Screw terminals

4 Contactor

Size S2
Screw terminals

Wiring kit

Screw terminals
3RA2933-2AA1

a Upper wiring module

b Lower wiring module

c Two connectors for two contactors

d Mechanical interlock 3RA2934-2B (not part of the wiring kit, must be ordered separately)

3RA22 load feeder for reversing duty and standard rail mounting in size S2
(the version with screw terminals is shown in the picture)

RH assembly kits for reversing duty and standard rail mounting
in size S2, [see page 8/51](#).

Load Feeders and Motor Starters for Use in the Control Cabinet

SIRIUS 3RA2 Load Feeders

General data

Reversing duty • For standard rail mounting • Size S3

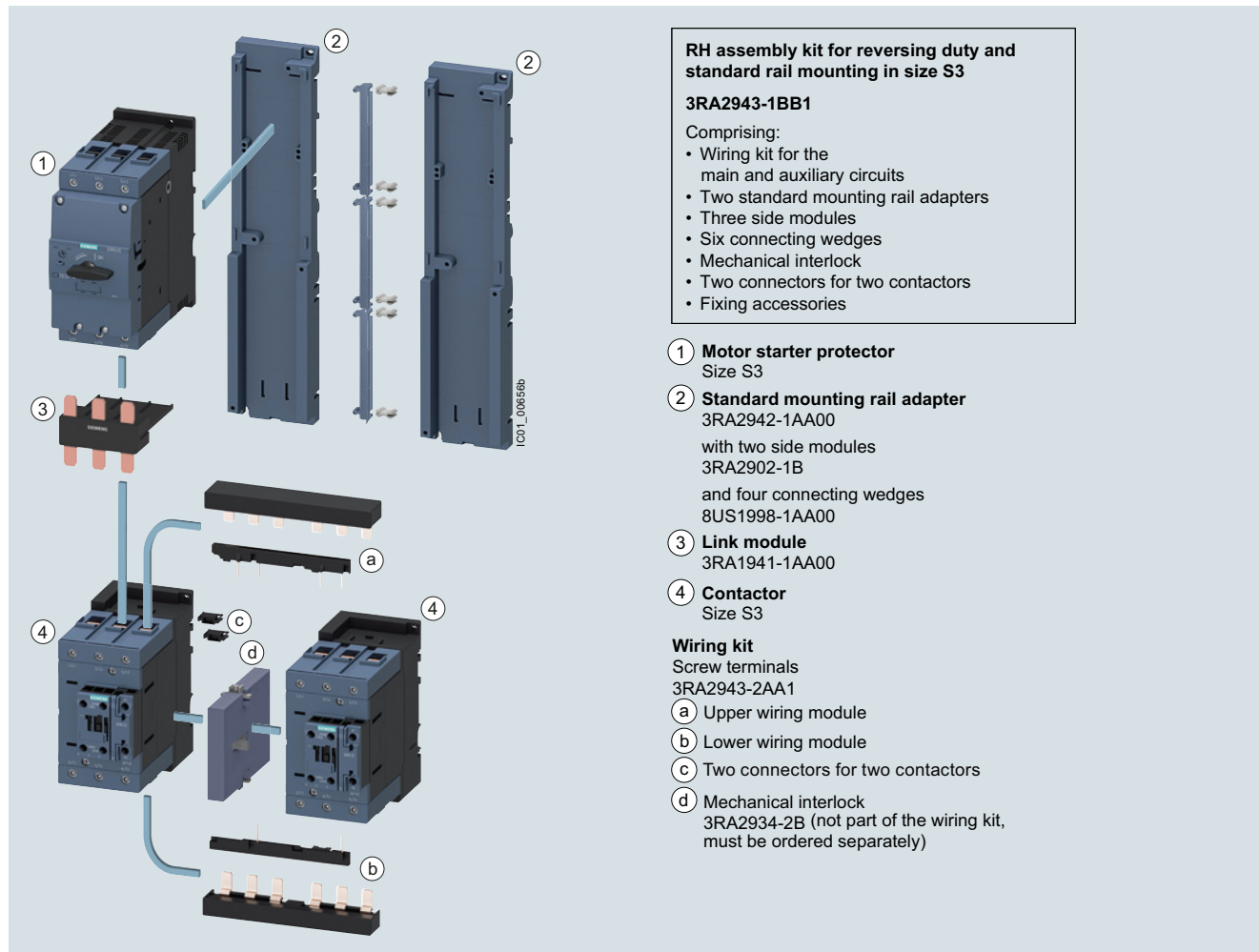

3RA22 load feeder for reversing duty and standard rail mounting in size S3
(the version with screw terminals is shown in the picture)

RH assembly kits for reversing duty and standard rail mounting
in size S3, [see page 8/51](#).

Load Feeders and Motor Starters for Use in the Control Cabinet

SIRIUS 3RA2 Load Feeders

General data

Reversing duty • For 60 mm busbar systems • Sizes S00 and S0

RS assembly kit for reversing duty and busbar mounting in size S00/S0

Screw terminals
3RA2913-1DB1 for S00
3RA2923-1DB1 for S0

Spring-loaded terminals
3RA2913-1DB2 for S00
3RA2923-1DB2 for S0¹⁾

Comprising:

- Wiring kit for the main and auxiliary circuits
- Busbar adapter
- Device holder
- Two connecting wedges
- Mechanical interlock
- Two connecting clips for two contactors
- Fixing accessories

1 Motor starter protector
 Size S00/S0
 Screw terminals/spring-loaded terminals

2 Link module
 Screw terminals
 3RA1921-1DA00 for S00
 3RA2921-1AA00 for S0, AC contactor
 3RA2921-1BA00 for S0, DC contactor

Spring-loaded terminals
 3RA2911-2AA00 for S00
 3RA2921-2AA00 for S0²⁾

3 60 mm busbar adapter
 Screw terminals
 8US1251-5DS10 for S00/S0
 8US1251-5NT10 for S0

Spring-loaded terminals
 8US1251-5DT11 for S00/S0
 8US1251-5NT11 for S0

2 connecting wedges
 8US1998-1AA00

60 mm device holder
 8US1250-5AS10 or
 8US1250-5AT10
 (according to left adapter)

4 Contactor
 Size S00/S0
 Screw terminals/spring-loaded terminals

Wiring kit

Screw terminals
 3RA2913-2AA1 for S00
 3RA2923-2AA1 for S0

Spring-loaded terminals
 3RA2913-2AA2 for S00
 3RA2923-2AA2 for S0

(a) Upper wiring module
(b) Lower wiring module
(c) Two connecting clips for two contactors
(d) Mechanical interlock
 (can be removed if necessary)

3RA22 load feeder for reversing duty and 60 mm busbar
 (the version with screw terminals is shown in the picture)

RS assembly kits for reversing duty and busbar mounting in size
 S00/S0, see page 8/53.

Load Feeders and Motor Starters for Use in the Control Cabinet

SIRIUS 3RA2 Load Feeders

General data

Reversing duty • For 60 mm busbar systems • Size S2

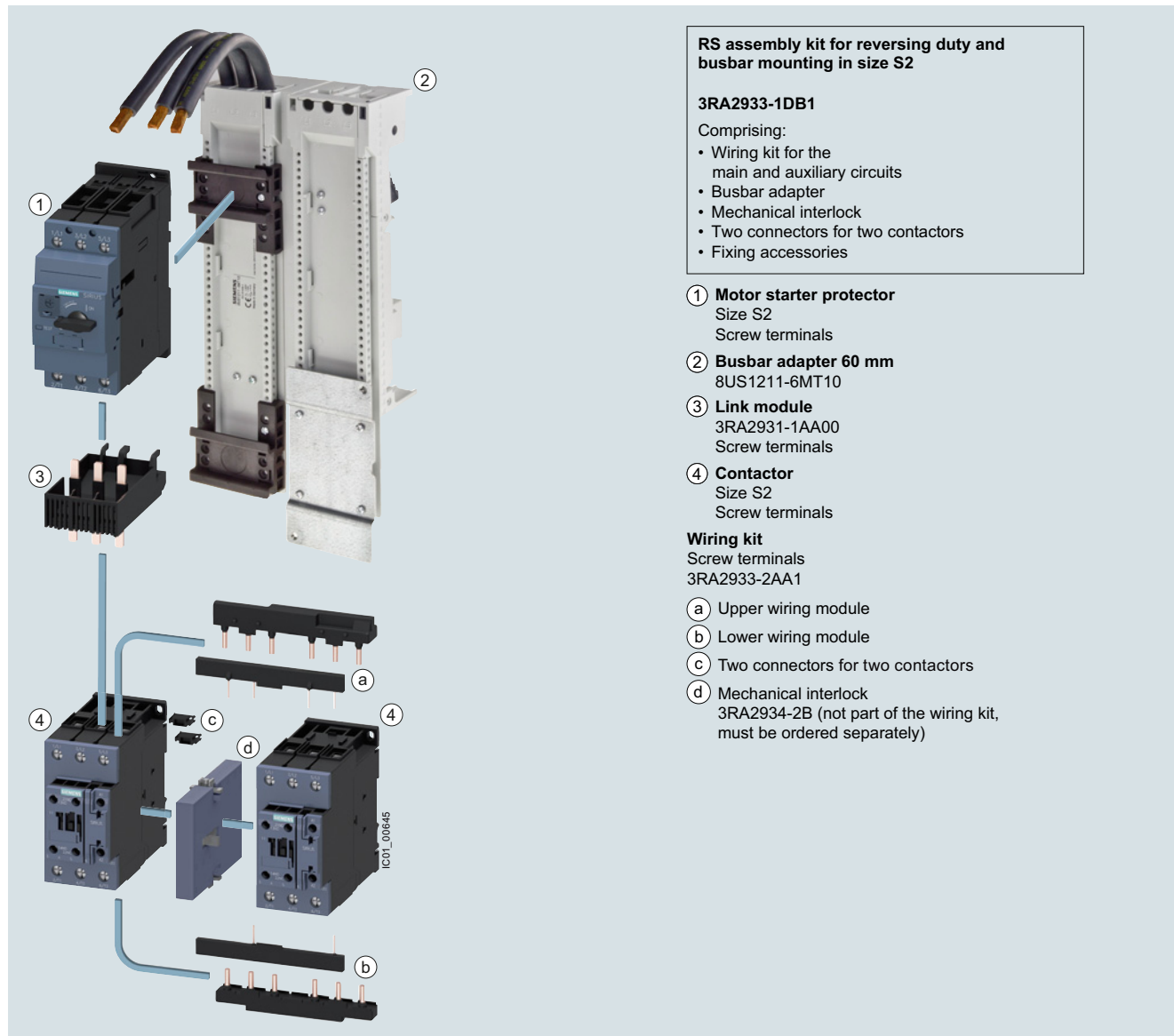

3RA22 load feeder for reversing duty and 60 mm busbar in size S2
(the version with screw terminals is shown in the picture)

RS assembly kits for reversing duty and busbar mounting in size S2, see [page 8/53](#).

Load Feeders and Motor Starters for Use in the Control Cabinet

SIRIUS 3RA2 Load Feeders

General data

Article No. scheme

Product versions		Article number													
SIRIUS load feeders		3RA2	<input type="checkbox"/>	<input type="checkbox"/>	0	-	<input type="checkbox"/>	<input type="checkbox"/>	<input type="checkbox"/>	<input type="checkbox"/>	-	<input type="checkbox"/>	<input type="checkbox"/>	<input type="checkbox"/>	<input type="checkbox"/>
Product function	Direct-on-line starter Reversing starter	1 2													For motor standard output 0.06 ... 45 kW For motor standard output 0.06 ... 45 kW
Size	S00 S0 e.g. 3 = S2 e.g. 5 = S2	1 2 <input type="checkbox"/> <input type="checkbox"/>													at $I_q = 100$ kA at 400 V at $I_q = 150$ kA at 400 V
Setting range of the overload release	e.g. 0B = 0.14 ... 0.2 A					<input type="checkbox"/>	<input type="checkbox"/>								
Assembly, assembly type, connection method	e.g. A = S00, S0, S2						<input type="checkbox"/>								Direct mounting, screw terminals
Contacteur size, rated power at 400 V AC	e.g. 15 = S00/3 kW							<input type="checkbox"/>	<input type="checkbox"/>						
Version	e.g. 0 = S0, S2									<input type="checkbox"/>					1 NO + 1 NC integrated in contactor
Auxiliary switches on the contactor	e.g. 1 = S00 e.g. 2 = S00									<input type="checkbox"/> <input type="checkbox"/>					1 NO integrated in contactor 1 NC integrated in contactor
Operating range of solenoid coil (contactor)	e.g. A = S00, S0, S2										<input type="checkbox"/>				AC $0.8 \times U_{s \min} \dots 1.1 \times U_{s \max}$, standard coil without RC circuit
Rated control supply voltage (contactor)	230 V AC 24 V DC												P 0 B 4		50/60 Hz AC for S00, 50 Hz AC for S0 ... S3
Example		3RA2	1	1	0	-	0	B	A	1	5	-	1	A	P 0

Note:

The Article No. scheme shows an overview of product versions for better understanding of the logic behind the article numbers.

For your orders, please use the article numbers quoted in the selection and ordering data.

Benefits

The 3RA2 fuseless load feeders offer a number of benefits:

- Minimum planning and assembly work and far less wiring with the preassembled complete units (only one article number 3RA2)
- Plug-in connectors from the motor starter protector to all types of SIRIUS controls, for quicker and error-free assembly of feeders with screw and spring-loaded terminals
- High planning reliability through consistent combination tests for fuseless and fused configuration in accordance with IEC and UL/CSA
- Comprehensive approvals for use world-wide on request, [see page 16/6 onwards](#).
- High operational reliability through short-circuit breaking capacity of 150 kA with type of coordination "1" and "2"
- Uniform accessories for sizes S00, S0, S2 and S3
- Spring-loaded terminals possible throughout: Enhanced operational reliability (vibration-resistant wiring) and less wiring work thanks to plug-in connections (S00 and S0 only)
- Power loss 5 to 10% smaller than for comparable devices, hence lower energy consumption
- Connection of feeders to the control system through standardized system connection (IO-Link and AS-i), for fast integration in TIA and less wiring work

Load Feeders and Motor Starters for Use in the Control Cabinet

SIRIUS 3RA2 Load Feeders

General data

Technical specifications

More information

Industry Mall, see www.siemens.com/product?3RA2

FAQs, see <https://support.industry.siemens.com/cs/ww/en/ps/16289/faq>

Equipment Manual, see <https://support.industry.siemens.com/cs/ww/en/view/60284351>

Configuration Manual, see <https://support.industry.siemens.com/cs/ww/en/view/39714188>

Direct-on-line starters/ reversing starters	Size	Connection method	Mounting	Control voltage	Width W	Height H	Depth D
					mm	mm	mm
Mounting dimensions							
Direct-on-line starters 3RA21. (Size S3 or larger is only available for self-assembly)	S00	Screw terminals	Standard mounting rails	AC/DC	45	167	97
			Busbar adapters	AC/DC	45	200	155
	3RA211.	Spring-loaded terminals	Standard mounting rails	AC/DC	45	198	97
			Busbar adapters	AC/DC	45	260	155
	S0 3RA212.	Screw terminals	Standard mounting rails	AC	45	193	97
				DC	45	193	107
		Busbar adapters	AC	45	260	155	
			DC	45	260	165	
	Spring-loaded terminals	Standard mounting rails	AC/DC	45	243	107	
		Busbar adapters	AC/DC	45	260	165	
	S2 3RA213./3RA215.	Screw terminals	Standard mounting rails	AC/DC	55	274	150
				Busbar adapters	AC/DC	55	350
S3 (self-assembly only)	Screw terminals	Standard mounting rail adapters	AC/DC	70	333	198	
Reversing starters 3RA22. (Size S2 or larger is only available for self-assembly)	S00	Screw terminals	Standard mounting rails	AC/DC	90	170	97
			Busbar adapters	AC/DC	90	200	155
	3RA221.	Spring-loaded terminals	Standard mounting rails	AC/DC	90	204	97
			Busbar adapters	AC/DC	90	260	155
	S0 3RA222.	Screw terminals	Standard mounting rail adapters	AC	90	265	120.3
				DC	90	265	130
		Busbar adapters	AC	90	260	155	
			DC	90	260	165	
	Spring-loaded terminals	Standard mounting rail adapters	AC/DC	90	270	131	
		Busbar adapters	AC/DC	90	260	165	
	S2 (self-assembly only)	Screw terminals	Standard mounting rails	AC/DC	120	295	175
				Busbar adapters	AC/DC	120	361
S3 (self-assembly only)	Screw terminals	Standard mounting rail adapters	AC/DC	150	333	198	

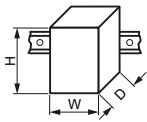

Type		3RA2.1	3RA2.2	3RA213, 3RA215	For self-assembly
Size		S00	S0	S2	S3
Number of poles		3	3	3	3
Mechanics and environment					
Permissible ambient temperature					
• During operation	°C	-20 ... +60			
• During storage and transport	°C	-55 ... +80			
Weight	kg	0.6 ... 1.5	0.8 ... 2.3	2.2 ... 2.5	4.0 ... 4.2
Permissible mounting position		<p>Important: Acc. to DIN 43602 start command "I" at the right or top</p>			
Shock resistance	Acc. to IEC 60068-2-27 g/ms	6/11 (sine pulse)			On request
Degree of protection	Acc. to IEC 60529	IP20		<ul style="list-style-type: none"> • IP20 on front side • Connecting terminal IP00 	
Touch protection	Acc. to IEC 60529	Finger-safe		Finger-safe, for vertical contact from the front	

Load Feeders and Motor Starters for Use in the Control Cabinet

SIRIUS 3RA2 Load Feeders

General data



Type		3RA2.1	3RA2.2	3RA213, 3RA215	For self-assembly
Size		S00	S0	S2	S3
Number of poles		3	3	3	3
Electrical specifications					
Standards					
		<ul style="list-style-type: none"> • IEC 60947-1, EN 60947-1 (VDE 0660 Part 100) • IEC 60947-2, EN 60947-2 (VDE 0660 Part 101) • IEC 60947-4-1, EN 60947-4-1 (VDE 0660 Part 102) 			
Max. rated current I_n max (= max. rated operational current I_Δ)	A	16	32	65	100
Rated operational voltage U_e	V	690			
Rated frequency	Hz	50/60			
Rated insulation voltage U_i (pollution degree 3)	V	690			
Rated impulse withstand voltage U_{imp}	kV	6			
Trip class (CLASS)	Acc. to IEC 60947-4-1, EN 60947-4-1 (VDE 0660 Part 102)	10			
Rated short-circuit current I_q at AC 50/60 Hz 400 V	Acc. to IEC 60947-4-1, EN 60947-4-1 (VDE 0660 Part 102)	150		3RA213: 100 3RA215: 150	With 3RV2041: 100 With 3RV2042: 150
Types of coordination	Acc. to IEC 60947-4-1, EN 60947-4-1 (VDE 0660 Part 102)	See "Selection and ordering data", page 8/21 onwards			
Power loss P_v of all main current paths Dependent on rated current I_n (upper setting range)		See technical specifications of the individual devices: <ul style="list-style-type: none"> • "Switching Devices – Contactors and Contactor Assemblies", page 3/29 • "Protection Equipment" → "Motor starter protectors/circuit breakers", pages 7/19 and 7/21 			
Power consumption of the solenoid coils with contactors		See technical specifications of the contactor, page 3/23 onwards			
Magnetic coil operating range with contactors					
Endurance of the motor starter protector					
• Mechanical endurance	Operating cycles	100 000		Up to 52 A: 50 000	25 000
• Electrical endurance	Operating cycles	100 000		From 59 A: 20 000	25 000
• Max. switching frequency per hour (motor starts)	1/h	15			
Endurance of contactor					
• Mechanical endurance	Operating cycles	30 million	10 million		
• Electrical endurance	Operating cycles	See endurance characteristic curves of the contactors, page 3/23 onwards			
Phase failure sensitivity of the motor starter protector	Acc. to IEC 60947-1, EN 60947-1 (VDE 0660 Part 102)	✓			
Isolating features of the motor starter protector	Acc. to IEC 60947-2, EN 60947-2 (VDE 0660 Part 101)	✓			
Main and EMERGENCY STOP switch characteristics of the motor starter protector and accessories	Acc. to IEC 60204-1, EN 60204-1 (VDE 0113 Part 1)	✓ (With overvoltage releases of category "1" under conditions of proper use)			
Protective separation between main and auxiliary circuits	Acc. to EN 60947-1, Appendix N	V	Up to 400		
Mirror contacts for contactors Integrated auxiliary switches		✓ Acc. to IEC 60947-4-1, Appendix F			

✓ Function available



Load Feeders and Motor Starters for Use in the Control Cabinet

SIRIUS 3RA2 Load Feeders

General data

Conductor cross-sections of main circuit						
Type		3RA2.10	3RA2.20	3RA2130-4E..., 3RA2130-4P..., 3RA2130-4U..., 3RA2130-4V...	3RA2130-4W..., 3RA2130-4X..., 3RA2130-4J..., 3RA2130-4K..., 3RA2150	For self-assembly
Size		S00	S0	S2		S3
Connection type		 Screw terminals				 Screw terminals with box terminal
Terminal screw		M3, Pozidriv size 2	M4, Pozidriv size 2	M6, Pozidriv size 2		4 mm Allen screw
Operating devices	mm	∅ 5 ... 6	∅ 5 ... 6	∅ 5 ... 6		Allen screw
Prescribed tightening torque	Nm	0.8 ... 1.2	2 ... 2.5	3.0 ... 4.5		4.5 ... 6
Conductor cross-sections (min./max.), 1 or 2 conductors can be connected						
• Solid or stranded	mm ²	2 x (0.75 ... 2.5) ¹⁾ , 2 x (0.5 ... 1.5) ¹⁾ , only for contactor 2 x 4	2 x (1 ... 2.5) ¹⁾ , 2 x (2.5 ... 10) ¹⁾	2 x (1 ... 25) ¹⁾ , 1 x (1 ... 35) ¹⁾	2 x (1 ... 35) ¹⁾ , 1 x (1 ... 50) ¹⁾	2 x (2.5 ... 16) ¹⁾ , 2 x (10 ... 50) ¹⁾ , 1 x (10 ... 70) ¹⁾
• Finely stranded with end sleeve (DIN 46228)	mm ²	2 x (0.5 ... 1.5) ¹⁾ , 2 x (0.75 ... 2.5) ¹⁾	2 x (1 ... 2.5) ¹⁾ , 2 x (2.5 ... 6) ¹⁾ , 1 x 10	2 x (1 ... 16) ¹⁾ , 1 x (1 ... 25) ¹⁾	2 x (1 ... 25) ¹⁾ , 1 x (1 ... 35) ¹⁾	2 x (2.5 ... 35) ¹⁾ , 1 x (2.5 ... 50) ¹⁾
• AWG cables, solid or stranded	AWG	2 x (20 ... 16) ¹⁾ , only for contactor 2 x (18 ... 14) ¹⁾ , 2 x 12	2 x (16 ... 12) ¹⁾ , 2 x (14 ... 8) ¹⁾	2 x (18 ... 3) ¹⁾ , 1 x (18 ... 2) ¹⁾	2 x (18 ... 2) ¹⁾ , 1 x (18 ... 1) ¹⁾	2 x (10 ... 1/0) ¹⁾ , 1 x (10 ... 2/0) ¹⁾
• Ribbon cable conductors (Number x Width x Thickness) mm	--	--	--	--	--	2 x (6 x 9 x 0.8)
Connection type		 Spring-loaded terminals				
Operating devices	mm	3.0 x 0.5 and 3.5 x 0.5				
Conductor cross-sections (min./max.), 1 or 2 conductors can be connected						
• Solid or stranded	mm ²	2 x (0.5 ... 4)	2 x (1 ... 10)	--		
• Finely stranded without end sleeve	mm ²	2 x (0.5 ... 2.5)	2 x (1 ... 6)	--		
• Finely stranded with end sleeve (DIN 46228)	mm ²	2 x (0.5 ... 2.5)	2 x (1 ... 6)	--		
• AWG cables, solid or stranded	AWG	2 x (20 ... 12)	2 x (18 ... 8)	--		
Max. external diameter of the conductor insulation	mm	3.6	3.6	--		

¹⁾ If two different conductor cross-sections are connected to one clamping point, both cross-sections must be in the range specified.

Conductor cross-sections for auxiliary and control circuits					
Type		3RA2110 3RA2210	3RA2120 3RA2220	3RA2130 3RA2150	For self-assembly
Size		S00	S0	S2	S3
Connection type		 Screw terminals			
Terminal screw		M3, Pozidriv size 2			
Operating devices	mm	∅ 5 ... 6			
Prescribed tightening torque	Nm	0.8 ... 1.2			
Conductor cross-sections (min./max.), 1 or 2 conductors can be connected					
• Solid or stranded	mm ²	2 x (0.5 ... 1.5) ¹⁾ , 2 x (0.75 ... 2.5) ¹⁾			
• Finely stranded with end sleeve (DIN 46228)	mm ²	2 x (0.5 ... 1.5) ¹⁾ , 2 x (0.75 ... 2.5) ¹⁾			
• AWG cables, solid or stranded	AWG	2 x (18 ... 14) ¹⁾ , 2 x (20 ... 16) ¹⁾ , 2 x 12 for contactor S00 only			
Connection type		 Spring-loaded terminals			
Operating devices	mm	3.0 x 0.5 and 3.5 x 0.5			
Conductor cross-sections (min./max.), 1 or 2 conductors can be connected					
• Solid or stranded	mm ²	2 x (0.5 ... 2.5)			
• Finely stranded without end sleeve	mm ²	2 x (0.5 ... 2.5)			
• Finely stranded with end sleeve (DIN 46228)	mm ²	2 x (0.5 ... 1.5)			
• AWG cables, solid or stranded	AWG	2 x (20 ... 14)			
Max. external diameter of the conductor insulation	mm	3.6			

¹⁾ If two different conductor cross-sections are connected to one clamping point, both cross-sections must be in the range specified.

Load Feeders and Motor Starters for Use in the Control Cabinet

SIRIUS 3RA2 Load Feeders

IE3/IE4 ready

3RA21 direct-on-line starters > for standard mounting rails or for screw fixing

Selection and ordering data



Direct-on-line start

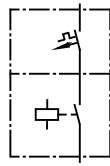

Rated control supply voltage
50/60 Hz 230 V AC for S00, 50 Hz 230 V AC for S0, S2 and S3

With screw terminals

- Screw fixing with two push-in lugs per load feeder possible¹⁾
- The motor starter protector and contactor are mechanically and electrically connected by means of the link module.
- Auxiliary switches²⁾ on the motor starter protector and the contactor can be easily fitted thanks to the modular system.
- Integrated auxiliary switches:
Contactor size S00: 1 NO,
Contactor sizes S0, S2 and S3: 1 NO + 1 NC

Size	Standard three-phase motor 4-pole at 400 V AC ³⁾	Adjustable current response value of the inverse-time delayed overload release	Comprising the following single devices			SD	Fuseless load feeder	PU (UNIT, SET, M)	PS*	PG
	Standard output <i>P</i>	Motor current <i>I</i> (guide value)	Motor starter protector	+ Contactor	+ Link module		Screw terminals			
	kW	A	A			d	Article No.	Basic price per PU		

Type of coordination "2" at $I_q = 150$ kA at 400 V (also compatible with type of coordination "1")

				3RV20	3RT20	3RA							
S00	0.06	0.2	0.14 ... 0.2	11-0BA10	15-1AP01	1921-1DA00	2	3RA2110-0BA15-1AP0	1	1 unit	41D		
	0.06	0.2	0.18 ... 0.25	11-0CA10			2	3RA2110-0CA15-1AP0	1	1 unit	41D		
	0.09	0.3	0.22 ... 0.32	11-0DA10			2	3RA2110-0DA15-1AP0	1	1 unit	41D		
	0.09	0.3	0.28 ... 0.4	11-0EA10			2	3RA2110-0EA15-1AP0	1	1 unit	41D		
	0.12	0.4	0.35 ... 0.5	11-0FA10			2	3RA2110-0FA15-1AP0	1	1 unit	41D		
	0.18	0.6	0.45 ... 0.63	11-0GA10			2	3RA2110-0GA15-1AP0	1	1 unit	41D		
	0.18	0.6	0.55 ... 0.8	11-0HA10			2	3RA2110-0HA15-1AP0	1	1 unit	41D		
	0.25	0.85	0.7 ... 1	11-0JA10			2	3RA2110-0JA15-1AP0	1	1 unit	41D		
	0.37	1.1	0.9 ... 1.25	11-0KA10			2	3RA2110-0KA15-1AP0	1	1 unit	41D		
	0.55	1.5	1.1 ... 1.6	11-1AA10			2	3RA2110-1AA15-1AP0	1	1 unit	41D		
	0.75	1.9	1.4 ... 2	11-1BA10			2	3RA2110-1BA15-1AP0	1	1 unit	41D		
	0.75	1.9	1.8 ... 2.5	11-1CA10			2	3RA2110-1CA15-1AP0	1	1 unit	41D		
	1.1	2.7	2.2 ... 3.2	11-1DA10			2	3RA2110-1DA15-1AP0	1	1 unit	41D		
	1.5	3.6	2.8 ... 4	11-1EA10			2	3RA2110-1EA15-1AP0	1	1 unit	41D		
	S0	1.5	3.6	3.5 ... 5	11-1FA10	24-1AP00	2921-1AA00	2	3RA2120-1FA24-0AP0	1	1 unit	41D	
		2.2	4.9	4.5 ... 6.3	11-1GA10			2	3RA2120-1GA24-0AP0	1	1 unit	41D	
3		6.5	5.5 ... 8	11-1HA10			2	3RA2120-1HA24-0AP0	1	1 unit	41D		
4		8.5	7 ... 10	11-1JA10			2	3RA2120-1JA24-0AP0	1	1 unit	41D		
5.5		11.5	9 ... 12	11-1KA10			2	3RA2120-1KA24-0AP0	1	1 unit	41D		
7.5		15.5	10 ... 16	21-4AA10	26-1AP00		2	3RA2120-4AA26-0AP0	1	1 unit	41D		
7.5		15.5	13 ... 20	21-4BA10	27-1AP00		5	3RA2120-4BA27-0AP0	1	1 unit	41D		
11		22	16 ... 22	21-4CA10			2	3RA2120-4CA27-0AP0	1	1 unit	41D		
11		22	18 ... 25	21-4DA10			2	3RA2120-4DA27-0AP0	1	1 unit	41D		
15		28	23 ... 28	21-4NA10			2	3RA2120-4NA27-0AP0	1	1 unit	41D		
15		29 ⁴⁾	27 ... 32	21-4EA10			2	3RA2120-4EA27-0AP0	1	1 unit	41D		
S2		15	29	22 ... 32	32-4EA10	35-1AP00	2931-1AA00	2	3RA2150-4EA35-0AP0	1	1 unit	41D	
		18.5	35	28 ... 36	32-4PA10			2	3RA2150-4PA35-0AP0	1	1 unit	41D	
	18.5	35	32 ... 40	32-4UA10			2	3RA2150-4UA35-0AP0	1	1 unit	41D		
	22	41	35 ... 45	32-4VA10	36-1AP00		2	3RA2150-4VA36-0AP0	1	1 unit	41D		
	22	41	42 ... 50	32-4WA10			2	3RA2150-4WA36-0AP0	1	1 unit	41D		
	30	55	49 ... 59	32-4XA10	37-1AP00		2	3RA2150-4XA37-0AP0	1	1 unit	41D		
	30	55	54 ... 65	32-4JA10			2	3RA2150-4JA37-0AP0	1	1 unit	41D		
37 ⁵⁾	66	62 ... 75	32-4KA10	38-1AP00		2	3RA2150-4KA38-0AP0	1	1 unit	41D			
S3	Size S3 available on request						Size S3 is only available for self-assembly						

¹⁾ For push-in lugs, see "Accessories" on page 8/51.

²⁾ For auxiliary switches, see "Accessories" on page 8/44.

³⁾ The actual starting and rated data of the motor to be protected must be considered when selecting the units.

⁴⁾ Suitable for use with IE3/IE4 motors up to a starting current of 256 A. For higher starting currents we recommend using size S2.

⁵⁾ Maximum permissible current setting at motor starter protector 65 A, as the maximum permissible current of the 3RA2931-1AA00 link module is 65 A.

Load Feeders and Motor Starters for Use in the Control Cabinet

SIRIUS 3RA2 Load Feeders

3RA21 direct-on-line starters > for standard mounting rails or for screw fixing **IE3/IE4 ready**



3RA2110

Direct-on-line start

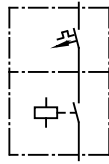

Rated control supply voltage
50/60 Hz 230 V AC for S00
With screw terminals

- Screw fixing¹⁾ with two push-in lugs per load feeder possible
- The motor starter protector and contactor are mechanically and electrically connected by means of the link module.
- Auxiliary switches²⁾ on the motor starter protector and the contactor can be easily fitted thanks to the modular system.
- Integrated auxiliary switches:
Contactor size S00: 1 NO

Size	Standard three-phase motor 4-pole at 400 V AC ³⁾	Adjustable current response value of the inverse-time delayed overload release	Comprising the following single devices			SD	Fuseless load feeder	PU (UNIT, SET, M)	PS*	PG
	Stand-ard output <i>P</i> (guide value)	Motor current <i>I</i> (guide value)	Motor starter protector	+ Contactor	+ Link module		Screw terminals			
	kW	A	A			d	Article No.	Basic price per PU		

Type of coordination "1" at $I_q = 150$ kA at 400 V
(motor starter protector is compatible with type of coordination "2")

			3RV20	3RT20	3RA						
S00	For load feeders for lower outputs, see this table at type of coordination "2".										
	1.5	3.6	3.5 ... 5	11-1FA10	15-1AP01	1921-1DA00	2	3RA2110-1FA15-1AP0	1	1 unit	41D
	2.2	4.9	4.5 ... 6.3	11-1GA10			2	3RA2110-1GA15-1AP0	1	1 unit	41D
	3	6.5	5.5 ... 8	11-1HA10			2	3RA2110-1HA15-1AP0	1	1 unit	41D
	4	8.5	7 ... 10	11-1JA10	16-1AP01		2	3RA2110-1JA16-1AP0	1	1 unit	41D
	5.5	11.5	9 ... 12	11-1KA10	17-1AP01		2	3RA2110-1KA17-1AP0	1	1 unit	41D
	7.5	15.5	10 ... 16	11-4AA10	18-1AP01		2	3RA2110-4AA18-1AP0	1	1 unit	41D

¹⁾ For push-in lugs, see "Accessories" on page 8/51.
²⁾ For auxiliary switches, see "Accessories" on page 8/44.
³⁾ The actual starting and rated data of the motor to be protected must be considered when selecting the units.

Load Feeders and Motor Starters for Use in the Control Cabinet

SIRIUS 3RA2 Load Feeders

IE3/IE4 ready

3RA21 direct-on-line starters > for standard mounting rails or for screw fixing



3RA2130

Direct-on-line start

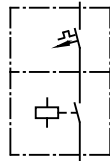

Rated control supply voltage
50 Hz 230 V AC for S2 and S3
With screw terminals

- Screw fixing with two push-in lugs per load feeder possible¹⁾
- The motor starter protector and contactor are mechanically and electrically connected by means of the link module.
- Auxiliary switches²⁾ on the motor starter protector and the contactor can be easily fitted thanks to the modular system.
- Integrated auxiliary switches:
 Contactor sizes S2 and S3: 1 NO + 1 NC

Size	Standard three-phase motor 4-pole at 400 V AC ³⁾	Adjustable current response value of the inverse-time delayed overload release	Comprising the following single devices			SD	Fuseless load feeder	PU (UNIT, SET, M)	PS*	PG
	Stand-ard output <i>P</i> (guide value)	Motor current <i>I</i> (value)	Motor starter protector	+ Contactor	+ Link module		Screw terminals			
	kW	A	A			d	Article No.	Basic price per PU		

Type of coordination "2" at $I_q = 100$ kA at 400 V
 (motor starter protector is compatible with type of coordination "2")

				3RV20	3RT20	3RA					
								ToC 2			
S2	15	29	22 ... 32	31-4EA10	35-1AP00	2931-1AA00	2	3RA2130-4EA35-0AP0	1	1 unit	41D
	18.5	35	28 ... 36	31-4PA10			2	3RA2130-4PA35-0AP0	1	1 unit	41D
	18.5	35	32 ... 40	31-4UA10			2	3RA2130-4UA35-0AP0	1	1 unit	41D
	22	41	35 ... 45	31-4VA10	36-1AP00		2	3RA2130-4VA36-0AP0	1	1 unit	41D
	22	41	42 ... 50	31-4WA10			2	3RA2130-4WA36-0AP0	1	1 unit	41D
	30	55	49 ... 59	31-4XA10	37-1AP00		2	3RA2130-4XA37-0AP0	1	1 unit	41D
	30	55	54 ... 65	31-4JA10			2	3RA2130-4JA37-0AP0	1	1 unit	41D
	37 ⁴⁾	66	62 ... 73	31-4KA10	38-1AP00		2	3RA2130-4KA38-0AP0	1	1 unit	41D
S3	Size S3 available on request								Size S3 is only available for self-assembly		

¹⁾ For push-in lugs, see "Accessories" on page 8/51.

²⁾ For auxiliary switches, see "Accessories" on page 8/44.

³⁾ The actual starting and rated data of the motor to be protected must be considered when selecting the units.

⁴⁾ Maximum permissible current setting at motor starter protector 65 A, as the maximum permissible current of the 3RA2931-1AA00 link module is 65 A.

Load Feeders and Motor Starters for Use in the Control Cabinet

SIRIUS 3RA2 Load Feeders

3RA21 direct-on-line starters > for standard mounting rails or for screw fixing **IE3/IE4 ready**



3RA2110



3RA2120

Direct-on-line start

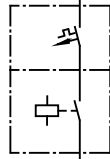

Rated control supply voltage
50/60 Hz 230 V AC for S00, 50 Hz 230 V AC for S0
With spring-loaded terminals

- Screw fixing with two push-in lugs per load feeder possible¹⁾
- The motor starter protector and contactor are mechanically and electrically connected by means of the link module.
- Auxiliary switches²⁾ on the motor starter protector and the contactor can be easily fitted thanks to the modular system.
- Integrated auxiliary switches:
Contactor size S00: 1 NO,
Contactor size S0: 1 NO + 1 NC

Size	Standard three-phase motor 4-pole at 400 V AC ³⁾		Adjustable current response value of the inverse-time delayed overload release	Comprising the following single devices			SD	Fuseless load feeder	PU (UNIT, SET, M)	PS*	PG
	Standard output P	Motor current I (guide value)		Motor starter protector	+ Contactor	+ Link module					
	kW	A	A								
								Article No.	Basic price per PU		

Type of coordination "2" at $I_q = 150$ kA at 400 V (also compatible with type of coordination "1")

				3RV20	3RT20	3RA29					
								ToC 2			
S00	0.06	0.2	0.14 ... 0.2	11-0BA20	15-2AP01	11-2AA00	2	3RA2110-0BE15-1AP0	1	1 unit	41D
	0.06	0.2	0.18 ... 0.25	11-0CA20			2	3RA2110-0CE15-1AP0	1	1 unit	41D
	0.09	0.3	0.22 ... 0.32	11-0DA20			2	3RA2110-0DE15-1AP0	1	1 unit	41D
	0.09	0.3	0.28 ... 0.4	11-0EA20			2	3RA2110-0EE15-1AP0	1	1 unit	41D
	0.12	0.4	0.35 ... 0.5	11-0FA20			2	3RA2110-0FE15-1AP0	1	1 unit	41D
	0.18	0.6	0.45 ... 0.63	11-0GA20			2	3RA2110-0GE15-1AP0	1	1 unit	41D
	0.18	0.6	0.55 ... 0.8	11-0HA20			2	3RA2110-0HE15-1AP0	1	1 unit	41D
	0.25	0.85	0.7 ... 1	11-0JA20			2	3RA2110-0JE15-1AP0	1	1 unit	41D
	0.37	1.1	0.9 ... 1.25	11-0KA20			2	3RA2110-0KE15-1AP0	1	1 unit	41D
	0.55	1.5	1.1 ... 1.6	11-1AA20			2	3RA2110-1AE15-1AP0	1	1 unit	41D
	0.75	1.9	1.4 ... 2	11-1BA20			2	3RA2110-1BE15-1AP0	1	1 unit	41D
	0.75	1.9	1.8 ... 2.5	11-1CA20			2	3RA2110-1CE15-1AP0	1	1 unit	41D
	1.1	2.7	2.2 ... 3.2	11-1DA20			2	3RA2110-1DE15-1AP0	1	1 unit	41D
	1.5	3.6	2.8 ... 4	11-1EA20			2	3RA2110-1EE15-1AP0	1	1 unit	41D
S0	1.5	3.6	3.5 ... 5	21-1FA20	24-2AP00	21-2AA00	5	3RA2120-1FE24-0AP0	1	1 unit	41D
	2.2	4.9	4.5 ... 6.3	21-1GA20			5	3RA2120-1GE24-0AP0	1	1 unit	41D
	3	6.5	5.5 ... 8	21-1HA20			5	3RA2120-1HE24-0AP0	1	1 unit	41D
	4	8.5	7 ... 10	21-1JA20			5	3RA2120-1JE24-0AP0	1	1 unit	41D
	5.5	11.5	9 ... 12	21-1KA20			5	3RA2120-1KE24-0AP0	1	1 unit	41D
	7.5	15.5	10 ... 16	21-4AA20	26-2AP00		5	3RA2120-4AE26-0AP0	1	1 unit	41D
	7.5	15.5	13 ... 20	21-4BA20	27-2AP00		5	3RA2120-4BE27-0AP0	1	1 unit	41D
	11	22	16 ... 22	21-4CA20			2	3RA2120-4CE27-0AP0	1	1 unit	41D
	11	22	18 ... 25	21-4DA20			2	3RA2120-4DE27-0AP0	1	1 unit	41D
	15	28	23 ... 28	21-4NA20			2	3RA2120-4NE27-0AP0	1	1 unit	41D
	15	29 ⁴⁾	27 ... 32	21-4EA20			2	3RA2120-4EE27-0AP0	1	1 unit	41D

Type of coordination "1" at $I_q = 150$ kA at 400 V (motor starter protector is compatible with type of coordination "2")

S00	For load feeders for lower outputs, see this table at type of coordination "2".										
								ToC 1			
	1.5	3.6	3.5 ... 5	11-1FA20	15-2AP01	11-2AA00	2	3RA2110-1FE15-1AP0	1	1 unit	41D
	2.2	4.9	4.5 ... 6.3	11-1GA20			2	3RA2110-1GE15-1AP0	1	1 unit	41D
	3	6.5	5.5 ... 8	11-1HA20			2	3RA2110-1HE15-1AP0	1	1 unit	41D
	4	8.5	7 ... 10	11-1JA20	16-2AP01		2	3RA2110-1JE16-1AP0	1	1 unit	41D
	5.5	11.5	9 ... 12	11-1KA20	17-2AP01		2	3RA2110-1KE17-1AP0	1	1 unit	41D
	7.5	15.5	10 ... 16	11-4AA20	18-2AP01		2	3RA2110-4AE18-1AP0	1	1 unit	41D

- 1) For push-in lugs, see "Accessories" on page 8/51.
- 2) For auxiliary switches, see "Accessories" on page 8/44.
- 3) The actual starting and rated data of the motor to be protected must be considered when selecting the units.
- 4) Suitable for use with IE3/IE4 motors up to a starting current of 256 A. For higher starting currents we recommend using size S2.

Load Feeders and Motor Starters for Use in the Control Cabinet

SIRIUS 3RA2 Load Feeders

IE3/IE4 ready

3RA21 direct-on-line starters > for standard mounting rails or for screw fixing



Direct-on-line start

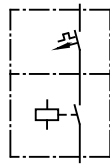

Rated control supply voltage 24 V DC With screw terminals

- Screw fixing with two push-in lugs per load feeder possible¹⁾
- The motor starter protector and contactor are mechanically and electrically connected by means of the link module.
- Auxiliary switches²⁾ on the motor starter protector and the contactor can be easily fitted thanks to the modular system.
- Integrated auxiliary switches:
Contactor size S00: 1 NO,
Contactor sizes S0, S2 and S3: 1 NO + 1 NC

Size	Standard three-phase motor 4-pole at 400 V AC ³⁾	Adjustable current response value of the inverse-time delayed overload release	Comprising the following single devices			SD	Fuseless load feeder	PU (UNIT, SET, M)	PS*	PG
	Standard output P	Motor current I (guide value)	Motor starter protector	+ Contactor	+ Link module		Screw terminals			
	kW	A	A			d	Article No.	Basic price per PU		

Type of coordination "2" at $I_q = 150$ kA at 400 V (also compatible with type of coordination "1")

				3RV20	3RT20	3RA		ToC 2			
S00	0.06	0.2	0.14 ... 0.2	11-0BA10	15-1BB41	1921-1DA00	2	3RA2110-0BA15-1BB4	1	1 unit	41D
	0.06	0.2	0.18 ... 0.25	11-0CA10			2	3RA2110-0CA15-1BB4	1	1 unit	41D
	0.09	0.3	0.22 ... 0.32	11-0DA10			2	3RA2110-0DA15-1BB4	1	1 unit	41D
	0.09	0.3	0.28 ... 0.4	11-0EA10			2	3RA2110-0EA15-1BB4	1	1 unit	41D
	0.12	0.4	0.35 ... 0.5	11-0FA10			2	3RA2110-0FA15-1BB4	1	1 unit	41D
	0.18	0.6	0.45 ... 0.63	11-0GA10			2	3RA2110-0GA15-1BB4	1	1 unit	41D
	0.18	0.6	0.55 ... 0.8	11-0HA10			2	3RA2110-0HA15-1BB4	1	1 unit	41D
	0.25	0.85	0.7 ... 1	11-0JA10			2	3RA2110-0JA15-1BB4	1	1 unit	41D
	0.37	1.1	0.9 ... 1.25	11-0KA10			2	3RA2110-0KA15-1BB4	1	1 unit	41D
	0.55	1.5	1.1 ... 1.6	11-1AA10			2	3RA2110-1AA15-1BB4	1	1 unit	41D
	0.75	1.9	1.4 ... 2	11-1BA10			2	3RA2110-1BA15-1BB4	1	1 unit	41D
	0.75	1.9	1.8 ... 2.5	11-1CA10			2	3RA2110-1CA15-1BB4	1	1 unit	41D
	1.1	2.7	2.2 ... 3.2	11-1DA10			2	3RA2110-1DA15-1BB4	1	1 unit	41D
	1.5	3.6	2.8 ... 4	11-1EA10			2	3RA2110-1EA15-1BB4	1	1 unit	41D
S0	1.5	3.6	3.5 ... 5	11-1FA10	24-1BB40	2921-1BA00	2	3RA2120-1FA24-0BB4	1	1 unit	41D
	2.2	4.9	4.5 ... 6.3	11-1GA10			2	3RA2120-1GA24-0BB4	1	1 unit	41D
	3	6.5	5.5 ... 8	11-1HA10			2	3RA2120-1HA24-0BB4	1	1 unit	41D
	4	8.5	7 ... 10	11-1JA10			2	3RA2120-1JA24-0BB4	1	1 unit	41D
	5.5	11.5	9 ... 12	11-1KA10			2	3RA2120-1KA24-0BB4	1	1 unit	41D
	7.5	15.5	10 ... 16	21-4AA10	26-1BB40		2	3RA2120-4AA26-0BB4	1	1 unit	41D
	7.5	15.5	13 ... 20	21-4BA10	27-1BB40		5	3RA2120-4BA27-0BB4	1	1 unit	41D
	11	22	16 ... 22	21-4CA10			2	3RA2120-4CA27-0BB4	1	1 unit	41D
	11	22	18 ... 25	21-4DA10			2	3RA2120-4DA27-0BB4	1	1 unit	41D
	15	28	23 ... 28	21-4NA10			2	3RA2120-4NA27-0BB4	1	1 unit	41D
	15	29 ⁴⁾	27 ... 32	21-4EA10			2	3RA2120-4EA27-0BB4	1	1 unit	41D
	S2	15	29	22 ... 32	32-4EA10	35-1NB30	2931-1AA00	2	3RA2150-4EA35-0NB3	1	1 unit
18.5		35	28 ... 36	32-4FA10			2	3RA2150-4FA35-0NB3	1	1 unit	41D
18.5		35	32 ... 40	32-4UA10			2	3RA2150-4UA35-0NB3	1	1 unit	41D
22		41	35 ... 45	32-4VA10	36-1NB30		2	3RA2150-4VA36-0NB3	1	1 unit	41D
22		41	42 ... 50	32-4WA10			2	3RA2150-4WA36-0NB3	1	1 unit	41D
30		55	49 ... 59	32-4XA10	37-1NB30		2	3RA2150-4XA37-0NB3	1	1 unit	41D
30		55	54 ... 65	32-4JA10			2	3RA2150-4JA37-0NB3	1	1 unit	41D
37 ⁵⁾		66	62 ... 73	32-4KA10	38-1NB30		2	3RA2150-4KA38-0NB3	1	1 unit	41D

S3 Size S3 available on request

Size S3 is only available for self-assembly

¹⁾ For push-in lugs, see "Accessories" on page 8/51.

²⁾ For auxiliary switches, see "Accessories" on page 8/44.

³⁾ The actual starting and rated data of the motor to be protected must be considered when selecting the units.

⁴⁾ Suitable for use with IE3/IE4 motors up to a starting current of 256 A. For higher starting currents we recommend using size S2.

⁵⁾ Maximum permissible current setting at motor starter protector 65 A, as the maximum permissible current of the 3RA2931-1AA00 link module is 65 A.

Load Feeders and Motor Starters for Use in the Control Cabinet

SIRIUS 3RA2 Load Feeders

3RA21 direct-on-line starters > for standard mounting rails or for screw fixing **IE3/IE4 ready**



3RA2110

Direct-on-line start

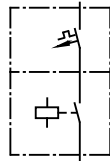

Rated control supply voltage 24 V DC With screw terminals

- Screw fixing with two push-in lugs per load feeder possible¹⁾
- The motor starter protector and contactor are mechanically and electrically connected by means of the link module.
- Auxiliary switches²⁾ on the motor starter protector and the contactor can be easily fitted thanks to the modular system.
- Integrated auxiliary switches:
Contactor size S00: 1 NO

Size	Standard three-phase motor 4-pole at 400 V AC ³⁾	Adjustable current response value of the inverse-time delayed overload release	Comprising the following single devices			SD	Fuseless load feeder	PU (UNIT, SET, M)	PS*	PG
	Standard output P	Motor current I (guide value)	Motor starter protector	+ Contactor	+ Link module		Screw terminals			
	kW	A	A			d	Article No.	Basic price per PU		

Type of coordination "1" at $I_{ca} = 150$ kA at 400 V
(motor starter protector is compatible with type of coordination "2")

3RV20 3RT20 3RA

S00	For load feeders for lower outputs, see this table at type of coordination "2".									
1.5	3.6	3.5 ... 5	11-1FA10	15-1BB41	1921-1DA00	2	3RA2110-1FA15-1BB4 3RA2110-1GA15-1BB4 3RA2110-1HA15-1BB4 3RA2110-1JA16-1BB4 3RA2110-1KA17-1BB4 3RA2110-4AA18-1BB4	1	1 unit	41D
2.2	4.9	4.5 ... 6.3	11-1GA10			2		1	1 unit	41D
3	6.5	5.5 ... 8	11-1HA10			2		1	1 unit	41D
4	8.5	7 ... 10	11-1JA10	16-1BB41		2		1	1 unit	41D
5.5	11.5	9 ... 12	11-1KA10	17-1BB41		2		1	1 unit	41D
7.5	15.5	10 ... 16	11-4AA10	18-1BB41		2	1	1 unit	41D	

¹⁾ For push-in lugs, see "Accessories" on page 8/51.

²⁾ For auxiliary switches, see "Accessories" on page 8/44.

³⁾ The actual starting and rated data of the motor to be protected must be considered when selecting the units.

Load Feeders and Motor Starters for Use in the Control Cabinet

SIRIUS 3RA2 Load Feeders

IE3/IE4 ready 3RA21 direct-on-line starters > for 60 mm busbars

Selection and ordering data



Direct-on-line start

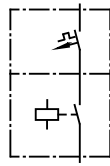

Rated control supply voltage
50/60 Hz 230 V AC for S00, 50 Hz 230 V AC for S0 and S2
With screw terminals

- With busbar adapter
- The motor starter protector and contactor are mechanically and electrically connected by means of the link module.
- Auxiliary switches¹⁾ on the motor starter protector and the contactor can be easily fitted thanks to the modular system.
- Integrated auxiliary switches:
Contactor size S00: 1 NO,
Contactor sizes S0 and S2: 1 NO + 1 NC

Size	Standard three-phase motor 4-pole at 400 V AC ²⁾		Adjustable current response value of the inverse-time delayed overload release	Comprising the following single devices			SD	Fuseless load feeder	PU (UNIT, SET, M)	PS*	PG
	Standard output P	Motor current I (guide value)		Motor starter protector	+ Contactor	+ Link module + Busbar adapter					
	kW	A	A				d	Article No.	Basic price per PU		

Type of coordination "2" at $I_q = 150$ kA at 400 V (also compatible with type of coordination "1")

Size	Standard three-phase motor 4-pole at 400 V AC ²⁾		Adjustable current response value of the inverse-time delayed overload release	Comprising the following single devices			SD	Fuseless load feeder	PU (UNIT, SET, M)	PS*	PG
	Standard output P	Motor current I (guide value)		Motor starter protector	+ Contactor	+ Link module + Busbar adapter					
	kW	A	A				d	Article No.	Basic price per PU		
Type of coordination "2" at $I_q = 150$ kA at 400 V (also compatible with type of coordination "1")											
				3RV20	3RT20	3RA					
S00	0.06	0.2	0.14 ... 0.2	11-0BA10	15-1AP01	1921-1DA00	2	3RA2110-0BD15-1AP0	1	1 unit	41D
	0.06	0.2	0.18 ... 0.25	11-0CA10		+ 8US1251-5DS10	2	3RA2110-0CD15-1AP0	1	1 unit	41D
	0.09	0.3	0.22 ... 0.32	11-0DA10			2	3RA2110-0DD15-1AP0	1	1 unit	41D
	0.09	0.3	0.28 ... 0.4	11-0EA10			2	3RA2110-0ED15-1AP0	1	1 unit	41D
	0.12	0.4	0.35 ... 0.5	11-0FA10			2	3RA2110-0FD15-1AP0	1	1 unit	41D
	0.18	0.6	0.45 ... 0.63	11-0GA10			2	3RA2110-0GD15-1AP0	1	1 unit	41D
	0.18	0.6	0.55 ... 0.8	11-0HA10			2	3RA2110-0HD15-1AP0	1	1 unit	41D
	0.25	0.85	0.7 ... 1	11-0JA10			2	3RA2110-0JD15-1AP0	1	1 unit	41D
	0.37	1.1	0.9 ... 1.25	11-0KA10			2	3RA2110-0KD15-1AP0	1	1 unit	41D
	0.55	1.5	1.1 ... 1.6	11-1AA10			2	3RA2110-1AD15-1AP0	1	1 unit	41D
	0.75	1.9	1.4 ... 2	11-1BA10			2	3RA2110-1BD15-1AP0	1	1 unit	41D
	0.75	1.9	1.8 ... 2.5	11-1CA10			2	3RA2110-1CD15-1AP0	1	1 unit	41D
	1.1	2.7	2.2 ... 3.2	11-1DA10			2	3RA2110-1DD15-1AP0	1	1 unit	41D
	1.5	3.6	2.8 ... 4	11-1EA10			2	3RA2110-1ED15-1AP0	1	1 unit	41D
S0	1.5	3.6	3.5 ... 5	11-1FA10	24-1AP00	2921-1AA00	2	3RA2120-1FD24-0AP0	1	1 unit	41D
	2.2	4.9	4.5 ... 6.3	11-1GA10		+ 8US1251-5DT10	2	3RA2120-1GD24-0AP0	1	1 unit	41D
	3	6.5	5.5 ... 8	11-1HA10			2	3RA2120-1HD24-0AP0	1	1 unit	41D
	4	8.5	7 ... 10	11-1JA10			2	3RA2120-1JD24-0AP0	1	1 unit	41D
	5.5	11.5	9 ... 12	11-1KA10			2	3RA2120-1KD24-0AP0	1	1 unit	41D
	7.5	15.5	10 ... 16	21-4AA10	26-1AP00	2921-1AA00	2	3RA2120-4AD26-0AP0	1	1 unit	41D
	7.5	15.5	13 ... 20	21-4BA10	27-1AP00	+ 8US1251-5NT10	5	3RA2120-4BD27-0AP0	1	1 unit	41D
	11	22	16 ... 22	21-4CA10			2	3RA2120-4CD27-0AP0	1	1 unit	41D
	11	22	18 ... 25	21-4DA10			2	3RA2120-4DD27-0AP0	1	1 unit	41D
	15	28	23 ... 28	21-4NA10			2	3RA2120-4ND27-0AP0	1	1 unit	41D
	15	29 ³⁾	27 ... 32	21-4EA10			2	3RA2120-4ED27-0AP0	1	1 unit	41D
S2	15	29	22 ... 32	32-4EA10	35-1AP00	2931-1AA00		Size S2 is only available for self-assembly.			
	18.5	35	28 ... 36	32-4PA10		+ 8US1261-6MT10					
	18.5	35	32 ... 40	32-4UA10							
	22	41	35 ... 45	32-4VA10	36-1AP00						
	22	41	42 ... 50	32-4WA10							
	30	55	49 ... 59	32-4XA10	37-1AP00						
	30	55	54 ... 65	32-4JA10							
	37 ⁴⁾	66	62 ... 73	32-4KA10	38-1AP00						

Type of coordination "1" at $I_q = 150$ kA at 400 V (motor starter protector is compatible with type of coordination "2")

Size	Standard three-phase motor 4-pole at 400 V AC ²⁾		Adjustable current response value of the inverse-time delayed overload release	Comprising the following single devices			SD	Fuseless load feeder	PU (UNIT, SET, M)	PS*	PG
	Standard output P	Motor current I (guide value)		Motor starter protector	+ Contactor	+ Link module + Busbar adapter					
	kW	A	A				d	Article No.	Basic price per PU		
S00	For load feeders for lower outputs, see this table at type of coordination "2".										
	1.5	3.6	3.5 ... 5	11-1FA10	15-1AP01	1921-1DA00	2	3RA2110-1FD15-1AP0	1	1 unit	41D
	2.2	4.9	4.5 ... 6.3	11-1GA10		+ 8US1251-5DS10	2	3RA2110-1GD15-1AP0	1	1 unit	41D
	3	6.5	5.5 ... 8	11-1HA10			2	3RA2110-1HD15-1AP0	1	1 unit	41D
	4	8.5	7 ... 10	11-1JA10	16-1AP01		2	3RA2110-1JD16-1AP0	1	1 unit	41D
	5.5	11.5	9 ... 12	11-1KA10	17-1AP01		2	3RA2110-1KD17-1AP0	1	1 unit	41D
	7.5	15.5	10 ... 16	11-4AA10	18-1AP01		2	3RA2110-4AD18-1AP0	1	1 unit	41D

¹⁾ For auxiliary switches, see "Accessories" on page 8/44.

²⁾ The actual starting and rated data of the motor to be protected must be considered when selecting the units.

³⁾ Suitable for use with IE3/IE4 motors up to a starting current of 256 A. For higher starting currents we recommend using size S2.

⁴⁾ Maximum permissible current setting at motor starter protector 65 A, as the maximum permissible current of the 3RA2931-1AA00 link module is 65 A.

Load Feeders and Motor Starters for Use in the Control Cabinet

SIRIUS 3RA2 Load Feeders

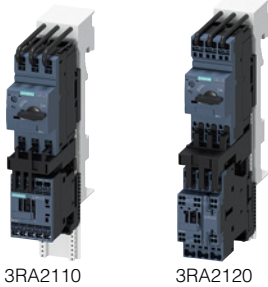
3RA21 direct-on-line starters > for 60 mm busbars **IE3/IE4 ready**

3RA2110

3RA2120

Direct-on-line start

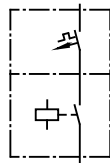

Rated control supply voltage
50/60 Hz 230 V AC for S00, 50 Hz 230 V AC for S0
With spring-loaded terminals

- With busbar adapter
- The motor starter protector and contactor are mechanically and electrically connected by means of the link module.
- Auxiliary switches¹⁾ on the motor starter protector and the contactor can be easily fitted thanks to the modular system.
- Integrated auxiliary switches:
 Contactor size S00: 1 NO,
 Contactor size S0: 1 NO + 1 NC

Size	Standard three-phase motor 4-pole at 400 V AC ²⁾		Adjustable current response value of the inverse-time delayed overload release	Comprising the following single devices			SD	Fuseless load feeder	PU (UNIT, SET, M)	PS*	PG
	Stand-ard output P	Motor current I		Motor starter protector	+ Contactor	+ Link module + Busbar adapter		Spring-loaded terminals			
	kW	A	A				d	Article No.	Basic price per PU		
Type of coordination "2" at I_q = 150 kA at 400 V (also compatible with type of coordination "1")											
				3RV20	3RT20	3RA29					
S00	0.06	0.2	0.14 ... 0.2	11-0BA20	15-2AP01	11-2AA00	2	3RA2110-0BH15-1AP0		1	1 unit 41D
	0.06	0.2	0.18 ... 0.25	11-0CA20		11-0CA20 + 8US1251-5DT11	2	3RA2110-0CH15-1AP0		1	1 unit 41D
	0.09	0.3	0.22 ... 0.32	11-0DA20			2	3RA2110-0DH15-1AP0		1	1 unit 41D
	0.09	0.3	0.28 ... 0.4	11-0EA20			2	3RA2110-0EH15-1AP0		1	1 unit 41D
	0.12	0.4	0.35 ... 0.5	11-0FA20			2	3RA2110-0FH15-1AP0		1	1 unit 41D
	0.18	0.6	0.45 ... 0.63	11-0GA20			2	3RA2110-0GH15-1AP0		1	1 unit 41D
	0.18	0.6	0.55 ... 0.8	11-0HA20			2	3RA2110-0HH15-1AP0		1	1 unit 41D
	0.25	0.85	0.7 ... 1	11-0JA20			2	3RA2110-0JH15-1AP0		1	1 unit 41D
	0.37	1.1	0.9 ... 1.25	11-0KA20			2	3RA2110-0KH15-1AP0		1	1 unit 41D
	0.55	1.5	1.1 ... 1.6	11-1AA20			2	3RA2110-1AH15-1AP0		1	1 unit 41D
	0.75	1.9	1.4 ... 2	11-1BA20			2	3RA2110-1BH15-1AP0		1	1 unit 41D
	0.75	1.9	1.8 ... 2.5	11-1CA20			2	3RA2110-1CH15-1AP0		1	1 unit 41D
	1.1	2.7	2.2 ... 3.2	11-1DA20			2	3RA2110-1DH15-1AP0		1	1 unit 41D
	1.5	3.6	2.8 ... 4	11-1EA20			2	3RA2110-1EH15-1AP0		1	1 unit 41D
S0	1.5	3.6	3.5 ... 5	21-1FA20	24-2AP00	21-2AA00	5	3RA2120-1FH24-0AP0		1	1 unit 41D
	2.2	4.9	4.5 ... 6.3	21-1GA20		21-2AA00 + 8US1251-5NT11 ³⁾	5	3RA2120-1GH24-0AP0		1	1 unit 41D
	3	6.5	5.5 ... 8	21-1HA20			5	3RA2120-1HH24-0AP0		1	1 unit 41D
	4	8.5	7 ... 10	21-1JA20			5	3RA2120-1JH24-0AP0		1	1 unit 41D
	5.5	11.5	9 ... 12	21-1KA20			5	3RA2120-1KH24-0AP0		1	1 unit 41D
	7.5	15.5	10 ... 16	21-4AA20	26-2AP00		2	3RA2120-4AH26-0AP0		1	1 unit 41D
	7.5	15.5	13 ... 20	21-4BA20	27-2AP00		5	3RA2120-4BH27-0AP0		1	1 unit 41D
	11	22	16 ... 22	21-4CA20			2	3RA2120-4CH27-0AP0		1	1 unit 41D
	11	22	18 ... 25	21-4DA20			2	3RA2120-4DH27-0AP0		1	1 unit 41D
	15	28	23 ... 28	21-4NA20			2	3RA2120-4NH27-0AP0		1	1 unit 41D
	15	29 ⁴⁾	27 ... 32	21-4EA20			2	3RA2120-4EH27-0AP0		1	1 unit 41D

Type of coordination "1" at I_q = 150 kA at 400 V
 (motor starter protector is compatible with type of coordination "2")

SD	For load feeders for lower outputs, see this table at type of coordination "2".										
S00	1.5	3.6	3.5 ... 5	11-1FA20	15-2AP01	11-2AA00	2	3RA2110-1FH15-1AP0		1	1 unit 41D
	2.2	4.9	4.5 ... 6.3	11-1GA20		11-2AA00 + 8US1251-5DT11	2	3RA2110-1GH15-1AP0		1	1 unit 41D
	3	6.5	5.5 ... 8	11-1HA20			2	3RA2110-1HH15-1AP0		1	1 unit 41D
	4	8.5	7 ... 10	11-1JA20	16-2AP01		2	3RA2110-1JH16-1AP0		1	1 unit 41D
	5.5	11.5	9 ... 12	11-1KA20	17-2AP01		2	3RA2110-1KH17-1AP0		1	1 unit 41D
	7.5	15.5	10 ... 16	11-4AA20	18-2AP01		2	3RA2110-4AH18-1AP0		1	1 unit 41D

¹⁾ For auxiliary switches, see "Accessories" on page 8/44.

²⁾ The actual starting and rated data of the motor to be protected must be considered when selecting the units.

³⁾ A 3RA2911-1CA00 spacer for height compensation on AC contactors size S0 with spring-loaded terminals is included in the scope of supply.

⁴⁾ Suitable for use with IE3/IE4 motors up to a starting current of 256 A. For higher starting currents we recommend using size S2.

Load Feeders and Motor Starters for Use in the Control Cabinet

SIRIUS 3RA2 Load Feeders

IE3/IE4 ready 3RA21 direct-on-line starters > for 60 mm busbars

Direct-on-line start

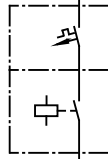
Rated control supply voltage 24 V DC
With screw terminals

- With busbar adapter
- The motor starter protector and contactor are mechanically and electrically connected by means of the link module.
- Auxiliary switches¹⁾ on the motor starter protector and the contactor can be easily fitted thanks to the modular system.
- Integrated auxiliary switches:
 Contactor size S00: 1 NO,
 Contactor sizes S0 and S2: 1 NO + 1 NC

Size	Standard three-phase motor 4-pole at 400 V AC ²⁾	Adjustable current response value of the inverse-time delayed overload release	Comprising the following single devices			SD	Fuseless load feeder	PU (UNIT, SET, M)	PS*	PG
	Stand-ard output P	Motor current I (guide value)	Motor starter protector	+ Contactor	+ Link module + Busbar adapter		Screw terminals			
	kW	A	A			d	Article No.	Basic price per PU		

Type of coordination "2" at $I_q = 150$ kA at 400 V
 (also compatible with type of coordination "1")

				3RV20	3RT20	3RA						
S00	0.06	0.2	0.14 ... 0.2	11-0BA10	15-1BB41	1921-1DA00	2	3RA2110-0BD15-1BB4	1	1 unit	41D	
	0.06	0.2	0.18 ... 0.25	11-0CA10		+ 8US1251-5DS10	2	3RA2110-0CD15-1BB4	1	1 unit	41D	
	0.09	0.3	0.22 ... 0.32	11-0DA10			2	3RA2110-0DD15-1BB4	1	1 unit	41D	
	0.09	0.3	0.28 ... 0.4	11-0EA10			2	3RA2110-0ED15-1BB4	1	1 unit	41D	
	0.12	0.4	0.35 ... 0.5	11-0FA10			2	3RA2110-0FD15-1BB4	1	1 unit	41D	
	0.18	0.6	0.45 ... 0.63	11-0GA10			2	3RA2110-0GD15-1BB4	1	1 unit	41D	
	0.18	0.6	0.55 ... 0.8	11-0HA10			2	3RA2110-0HD15-1BB4	1	1 unit	41D	
	0.25	0.85	0.7 ... 1	11-0JA10			2	3RA2110-0JD15-1BB4	1	1 unit	41D	
	0.37	1.1	0.9 ... 1.25	11-0KA10			2	3RA2110-0KD15-1BB4	1	1 unit	41D	
	0.55	1.5	1.1 ... 1.6	11-1AA10			2	3RA2110-1AD15-1BB4	1	1 unit	41D	
	0.75	1.9	1.4 ... 2	11-1BA10			2	3RA2110-1BD15-1BB4	1	1 unit	41D	
	0.75	1.9	1.8 ... 2.5	11-1CA10			2	3RA2110-1CD15-1BB4	1	1 unit	41D	
	1.1	2.7	2.2 ... 3.2	11-1DA10			2	3RA2110-1DD15-1BB4	1	1 unit	41D	
	1.5	3.6	2.8 ... 4	11-1EA10			2	3RA2110-1ED15-1BB4	1	1 unit	41D	
	S0	1.5	3.6	3.5 ... 5	11-1FA10	24-1BB40	2921-1BA00	2	3RA2120-1FD24-0BB4	1	1 unit	41D
2.2		4.9	4.5 ... 6.3	11-1GA10		+ 8US1251-5DT10	2	3RA2120-1GD24-0BB4	1	1 unit	41D	
3		6.5	5.5 ... 8	11-1HA10			2	3RA2120-1HD24-0BB4	1	1 unit	41D	
4		8.5	7 ... 10	11-1JA10			2	3RA2120-1JD24-0BB4	1	1 unit	41D	
5.5		11.5	9 ... 12	11-1KA10			2	3RA2120-1KD24-0BB4	1	1 unit	41D	
7.5		15.5	10 ... 16	21-4AA10	26-1BB40	2921-1BA00	2	3RA2120-4AD26-0BB4	1	1 unit	41D	
7.5		15.5	13 ... 20	21-4BA10	27-1BB40	+ 8US1251-5NT10	5	3RA2120-4BD27-0BB4	1	1 unit	41D	
11		22	16 ... 22	21-4CA10			2	3RA2120-4CD27-0BB4	1	1 unit	41D	
11		22	18 ... 25	21-4DA10			2	3RA2120-4DD27-0BB4	1	1 unit	41D	
15		28	23 ... 28	21-4NA10			2	3RA2120-4ND27-0BB4	1	1 unit	41D	
15		29 ³⁾	27 ... 32	21-4EA10			2	3RA2120-4ED27-0BB4	1	1 unit	41D	
S2	15	29	22 ... 32	32-4EA10	35-1NB30	2931-1AA00		Size S2 is only available for self-assembly.				
	18.5	35	28 ... 36	32-4PA10		+ 8US1261-6MT10						
	18.5	35	32 ... 40	32-4UA10								
	22	41	35 ... 45	32-4VA10	36-1NB30							
	22	41	42 ... 50	32-4WA10								
	30	55	49 ... 59	32-4XA10	37-1NB30							
	30	55	54 ... 65	32-4JA10								
	37 ⁴⁾	66	62 ... 73	32-4KA10	38-1NB30							

Type of coordination "1" at $I_q = 150$ kA at 400 V
 (motor starter protector is compatible with type of coordination "2")

S00	For load feeders for lower outputs, see this table at type of coordination "2".									
1.5	3.6	3.5 ... 5	11-1FA10	15-1BB41	1921-1DA00	2	3RA2110-1FD15-1BB4	1	1 unit	41D
2.2	4.9	4.5 ... 6.3	11-1GA10		+ 8US1251-5DS10	2	3RA2110-1GD15-1BB4	1	1 unit	41D
3	6.5	5.5 ... 8	11-1HA10			2	3RA2110-1HD15-1BB4	1	1 unit	41D
4	8.5	7 ... 10	11-1JA10	16-1BB41		2	3RA2110-1JD16-1BB4	1	1 unit	41D
5.5	11.5	9 ... 12	11-1KA10	17-1BB41		2	3RA2110-1KD17-1BB4	1	1 unit	41D
7.5	15.5	10 ... 16	11-4AA10	18-1BB41		2	3RA2110-4AD18-1BB4	1	1 unit	41D

¹⁾ For auxiliary switches, see "Accessories" on page 8/44.

²⁾ The actual starting and rated data of the motor to be protected must be considered when selecting the units.

³⁾ Suitable for use with IE3/IE4 motors up to a starting current of 256 A. For higher starting currents we recommend using size S2.

⁴⁾ Maximum permissible current setting at motor starter protector 65 A, as the maximum permissible current of the 3RA2931-1AA00 link module is 65 A.

Load Feeders and Motor Starters for Use in the Control Cabinet

SIRIUS 3RA2 Load Feeders

IE3/IE4 ready 3RA22 reversing starters > for standard mounting rails or for screw fixing

Selection and ordering data



Reversing duty

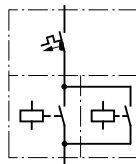

Rated control supply voltage
50/60 Hz 230 V AC for S00, 50 Hz 230 V AC for S0, S2 and S3

With screw terminals

- Screw fixing with two push-in lugs per load feeder possible¹⁾
- Without standard mounting rail adapter for size S00
- With 2 standard mounting rail adapters for size S0 for mechanical reinforcement (included in the scope of supply)
- The motor starter protector and contactor are mechanically and electrically connected by means of the link module.
- Auxiliary switches²⁾ on the motor starter protector and the contactor can be easily fitted thanks to the modular system.
- With contactor sizes S0, S2 and S3, an integrated NO contact is still available for free use.

Size	Standard three-phase motor 4-pole at 400 V AC ³⁾		Adjustable current response value of the inverse-time delayed overload release	Comprising the following single devices			SD	Fuseless load feeder	PU (UNIT, SET, M)	PS*	PG	
	Standard output P (guide value)	Motor current I (guide value)		Motor starter protector	+ 2 contactors	+ Link module + Assembly kit RH ⁴⁾ / Wiring kit						
3RA2210												
3RA2220												
	kW	A	A				d	Article No.	Basic price per PU			
Type of coordination "2" at I_q = 150 kA at 400 V (also compatible with type of coordination "1")												
				3RV20	3RT20	3RA						
S00	0.06	0.2	0.14 ... 0.2	11-0BA10	15-1AP02	1921-1DA00	2	3RA2210-0BA15-2AP0		1	1 unit	41D
	0.06	0.2	0.18 ... 0.25	11-0CA10		+ 2913-2AA1	2	3RA2210-0CA15-2AP0		1	1 unit	41D
	0.09	0.3	0.22 ... 0.32	11-0DA10			2	3RA2210-0DA15-2AP0		1	1 unit	41D
	0.09	0.3	0.28 ... 0.4	11-0EA10			2	3RA2210-0EA15-2AP0		1	1 unit	41D
	0.12	0.4	0.35 ... 0.5	11-0FA10			2	3RA2210-0FA15-2AP0		1	1 unit	41D
	0.18	0.6	0.45 ... 0.63	11-0GA10			2	3RA2210-0GA15-2AP0		1	1 unit	41D
	0.18	0.6	0.55 ... 0.8	11-0HA10			2	3RA2210-0HA15-2AP0		1	1 unit	41D
	0.25	0.85	0.7 ... 1	11-0JA10			2	3RA2210-0JA15-2AP0		1	1 unit	41D
	0.37	1.1	0.9 ... 1.25	11-0KA10			2	3RA2210-0KA15-2AP0		1	1 unit	41D
	0.55	1.5	1.1 ... 1.6	11-1AA10			2	3RA2210-1AA15-2AP0		1	1 unit	41D
	0.75	1.9	1.4 ... 2	11-1BA10			2	3RA2210-1BA15-2AP0		1	1 unit	41D
	0.75	1.9	1.8 ... 2.5	11-1CA10			2	3RA2210-1CA15-2AP0		1	1 unit	41D
	1.1	2.7	2.2 ... 3.2	11-1DA10			2	3RA2210-1DA15-2AP0		1	1 unit	41D
	1.5	3.6	2.8 ... 4	11-1EA10			2	3RA2210-1EA15-2AP0		1	1 unit	41D
S0	1.5	3.6	3.5 ... 5	11-1FA10	24-1AP00	2921-1AA00	2	3RA2220-1FB24-0AP0		1	1 unit	41D
	2.2	4.9	4.5 ... 6.3	11-1GA10		+ 2923-1BB1	2	3RA2220-1GB24-0AP0		1	1 unit	41D
	3	6.5	5.5 ... 8	11-1HA10			2	3RA2220-1HB24-0AP0		1	1 unit	41D
	4	8.5	7 ... 10	11-1JA10			2	3RA2220-1JB24-0AP0		1	1 unit	41D
	5.5	11.5	9 ... 12	11-1KA10			2	3RA2220-1KB24-0AP0		1	1 unit	41D
	7.5	15.5	10 ... 16	21-4AA10	26-1AP00		2	3RA2220-4AB26-0AP0		1	1 unit	41D
	7.5	15.5	13 ... 20	21-4BA10	27-1AP00		5	3RA2220-4BB27-0AP0		1	1 unit	41D
	11	22	16 ... 22	21-4CA10			2	3RA2220-4CB27-0AP0		1	1 unit	41D
	11	22	18 ... 25	21-4DA10			2	3RA2220-4DB27-0AP0		1	1 unit	41D
	15	28	23 ... 28	21-4NA10			2	3RA2220-4NB27-0AP0		1	1 unit	41D
	15	29 ⁵⁾	27 ... 32	21-4EA10			2	3RA2220-4EB27-0AP0		1	1 unit	41D
S2	15	29	22 ... 32	32-4EA10	35-1AP00	2931-1AA00		Size S2 is only available for self-assembly.				
	18.5	35	28 ... 36	32-4PA10		+ 2933-1BB1						
	18.5	35	32 ... 40	32-4UA10								
	22	41	35 ... 45	32-4VA10	36-1AP00							
	22	41	42 ... 50	32-4WA10								
	30	55	49 ... 59	32-4XA10	37-1AP00							
	30	55	54 ... 65	32-4JA10								
	37 ⁶⁾	66	62 ... 73	32-4KA10	38-1AP00							
S3	Size S3 available on request						Size S3 is only available for self-assembly					

¹⁾ For push-in lugs, see "Accessories" on page 8/51.

²⁾ For auxiliary switches, see "Accessories" on page 8/44.

³⁾ The actual starting and rated data of the motor to be protected must be considered when selecting the units.

⁴⁾ RH = assembly kit for reversing duty and standard rail mounting in sizes S0 and S2.

⁵⁾ Suitable for use with IE3/IE4 motors up to a starting current of 256 A. For higher starting currents we recommend using size S2.

⁶⁾ Maximum permissible current setting at motor starter protector 65 A, as the maximum permissible current of the 3RA2931-1AA00 link module is 65 A.

Load Feeders and Motor Starters for Use in the Control Cabinet

SIRIUS 3RA2 Load Feeders

3RA22 reversing starters > for standard mounting rails or for screw fixing **IE3/IE4 ready**



3RA2210

Reversing duty

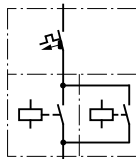

Rated control supply voltage
50/60 Hz 230 V AC for S00, 50 Hz 230 V AC for S0
With screw terminals

- Screw fixing with two push-in lugs per load feeder possible¹⁾
- Without standard mounting rail adapter for size S00
- The motor starter protector and contactor are mechanically and electrically connected by means of the link module.
- Auxiliary switches²⁾ on the motor starter protector and the contactor can be easily fitted thanks to the modular system.

Size	Standard three-phase motor 4-pole at 400 V AC ³⁾	Adjustable current response value of the inverse-time delayed overload release	Comprising the following single devices			SD	Fuseless load feeder	PU (UNIT, SET, M)	PS*	PG
	Stand-ard output P	Motor current I (guide value)	Motor starter protector	+ 2 contactors	+ Link module + Assembly kit RH ⁴⁾ / Wiring kit		Screw terminals			
						Article No.	Basic price per PU			
	kW	A	A			d				

Type of coordination "1" at $I_q = 150$ kA at 400 V
(motor starter protector is compatible with type of coordination "2")

			3RV20	3RT20	3RA						
S00	For load feeders for lower outputs, see this table at type of coordination "2".										
							ToC 1				
1.5	3.6	3.5 ... 5	11-1FA10	15-1AP02	1921-1DA00	2	3RA2210-1FA15-2AP0	1	1 unit	41D	
2.2	4.9	4.5 ... 6.3	11-1GA10		+ 2913-2AA1	2	3RA2210-1GA15-2AP0	1	1 unit	41D	
3	6.5	5.5 ... 8	11-1HA10			2	3RA2210-1HA15-2AP0	1	1 unit	41D	
4	8.5	7 ... 10	11-1JA10	16-1AP02		2	3RA2210-1JA16-2AP0	1	1 unit	41D	
5.5	11.5	9 ... 12	11-1KA10	17-1AP02		2	3RA2210-1KA17-2AP0	1	1 unit	41D	
7.5	15.5	10 ... 16	11-4AA10	18-1AP02		2	3RA2210-4AA18-2AP0	1	1 unit	41D	

¹⁾ For push-in lugs, see "Accessories" on page 8/51.

²⁾ For auxiliary switches, see "Accessories" on page 8/44.

³⁾ The actual starting and rated data of the motor to be protected must be considered when selecting the units.

⁴⁾ RH = assembly kit for reversing duty and standard rail mounting in sizes S0 and S2.

Load Feeders and Motor Starters for Use in the Control Cabinet

SIRIUS 3RA2 Load Feeders

IE3/IE4 ready 3RA22 reversing starters > for standard mounting rails or for screw fixing

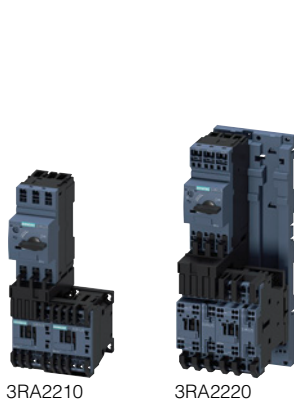

Reversing duty

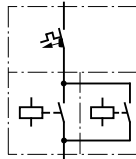

Rated control supply voltage
50/60 Hz 230 V AC for S00, 50 Hz 230 V AC for S0
With spring-loaded terminals

- Screw fixing with two push-in lugs per load feeder possible¹⁾
- Without standard mounting rail adapter for size S00
- With two standard mounting rail adapters for size S0 for mechanical reinforcement (included in the scope of supply)
- The motor starter protector and contactor are mechanically and electrically connected by means of the link module.
- Auxiliary switches²⁾ on the motor starter protector and the contactor can be easily fitted thanks to the modular system.
- With the contactor S0, an integrated NO contact is still available for free use.

Size	Standard three-phase motor 4-pole at 400 V AC ³⁾	Adjustable current response value of the inverse-time delayed overload release	Comprising the following single devices			SD	Fuseless load feeder	PU (UNIT, SET, M)	PS*	PG
	Standard output P	Motor current I (guide value)	Motor starter protector	+ 2 contactors	+ Link module + Assembly kit RH ⁴⁾ / Wiring kit		Spring-loaded terminals			
	kW	A	A			d	Article No.	Basic price per PU		

Type of coordination "2" at $I_q = 150$ kA at 400 V (also compatible with type of coordination "1")

				3RV20	3RT20	3RA29						
								ToC 2				
S00	0.06	0.2	0.14 ... 0.2	11-0BA20	15-2AP02	11-2AA00 + 13-2AA2	2	3RA2210-0BE15-2AP0	1	1 unit	41D	
	0.06	0.2	0.18 ... 0.25	11-0CA20			2	3RA2210-0CE15-2AP0	1	1 unit	41D	
	0.09	0.3	0.22 ... 0.32	11-0DA20			2	3RA2210-0DE15-2AP0	1	1 unit	41D	
	0.09	0.3	0.28 ... 0.4	11-0EA20			2	3RA2210-0EE15-2AP0	1	1 unit	41D	
	0.12	0.4	0.35 ... 0.5	11-0FA20			2	3RA2210-0FE15-2AP0	1	1 unit	41D	
	0.18	0.6	0.45 ... 0.63	11-0GA20			2	3RA2210-0GE15-2AP0	1	1 unit	41D	
	0.18	0.6	0.55 ... 0.8	11-0HA20			2	3RA2210-0HE15-2AP0	1	1 unit	41D	
	0.25	0.85	0.7 ... 1	11-0JA20			2	3RA2210-0JE15-2AP0	1	1 unit	41D	
	0.37	1.1	0.9 ... 1.25	11-0KA20			2	3RA2210-0KE15-2AP0	1	1 unit	41D	
	0.55	1.5	1.1 ... 1.6	11-1AA20			2	3RA2210-1AE15-2AP0	1	1 unit	41D	
	0.75	1.9	1.4 ... 2	11-1BA20			2	3RA2210-1BE15-2AP0	1	1 unit	41D	
	0.75	1.9	1.8 ... 2.5	11-1CA20			2	3RA2210-1CE15-2AP0	1	1 unit	41D	
	1.1	2.7	2.2 ... 3.2	11-1DA20			2	3RA2210-1DE15-2AP0	1	1 unit	41D	
	1.5	3.6	2.8 ... 4	11-1EA20			2	3RA2210-1EE15-2AP0	1	1 unit	41D	
S0	1.5	3.6	3.5 ... 5	21-1FA20	24-2AP00	21-2AA00 + 23-1BB2 ⁵⁾	5	3RA2220-1FF24-0AP0	1	1 unit	41D	
	2.2	4.9	4.5 ... 6.3	21-1GA20			5	3RA2220-1GF24-0AP0	1	1 unit	41D	
	3	6.5	5.5 ... 8	21-1HA20			5	3RA2220-1HF24-0AP0	1	1 unit	41D	
	4	8.5	7 ... 10	21-1JA20			5	3RA2220-1JF24-0AP0	1	1 unit	41D	
	5.5	11.5	9 ... 12	21-1KA20			5	3RA2220-1KF24-0AP0	1	1 unit	41D	
	7.5	15.5	10 ... 16	21-4AA20	26-2AP00		2	3RA2220-4AF26-0AP0	1	1 unit	41D	
	7.5	15.5	13 ... 20	21-4BA20	27-2AP00		5	3RA2220-4BF27-0AP0	1	1 unit	41D	
	11	22	16 ... 22	21-4CA20			2	3RA2220-4CF27-0AP0	1	1 unit	41D	
	11	22	18 ... 25	21-4DA20			2	3RA2220-4DF27-0AP0	1	1 unit	41D	
	15	28	23 ... 28	21-4NA20			2	3RA2220-4NF27-0AP0	1	1 unit	41D	
	15	29 ⁶⁾	27 ... 32	21-4EA20			2	3RA2220-4EF27-0AP0	1	1 unit	41D	

Type of coordination "1" at $I_q = 150$ kA at 400 V (motor starter protector is compatible with type of coordination "2")

S00	For load feeders for lower outputs, see this table at type of coordination "2".												
								ToC 1					
	1.5	3.6	3.5 ... 5	11-1FA20	15-2AP02	11-2AA00 + 13-2AA2	2	3RA2210-1FE15-2AP0	1	1 unit	41D		
	2.2	4.9	4.5 ... 6.3	11-1GA20			2	3RA2210-1GE15-2AP0	1	1 unit	41D		
	3	6.5	5.5 ... 8	11-1HA20			2	3RA2210-1HE15-2AP0	1	1 unit	41D		
	4	8.5	7 ... 10	11-1JA20	16-2AP02		2	3RA2210-1JE16-2AP0	1	1 unit	41D		
	5.5	11.5	9 ... 12	11-1KA20	17-2AP02		2	3RA2210-1KE17-2AP0	1	1 unit	41D		
	7.5	15.5	10 ... 16	11-4AA20	18-2AP02		2	3RA2210-4AE18-2AP0	1	1 unit	41D		

¹⁾ For push-in lugs, see "Accessories" on page 8/51.

²⁾ For auxiliary switches, see "Accessories" on page 8/44.

³⁾ The actual starting and rated data of the motor to be protected must be considered when selecting the units.

⁴⁾ RH = assembly kit for reversing duty and standard rail mounting in size S0.

⁵⁾ The RH assembly kit also includes the 3RA2911-1CA00 spacer for height compensation on AC contactors size S0 with spring-loaded terminals.

⁶⁾ Suitable for use with IE3/IE4 motors up to a starting current of 256 A. For higher starting currents we recommend using size S2.

Load Feeders and Motor Starters for Use in the Control Cabinet

SIRIUS 3RA2 Load Feeders

3RA22 reversing starters > for standard mounting rails or for screw fixing **IE3/IE4 ready**



3RA2210

3RA2220

Reversing duty

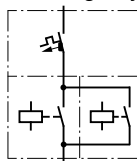

Rated control supply voltage 24 V DC

With screw terminals

- Screw fixing with two push-in lugs per load feeder possible¹⁾
- Without standard mounting rail adapter for size S00
- With two standard mounting rail adapters for size S0 for mechanical reinforcement (included in the scope of supply)
- The motor starter protector and contactor are mechanically and electrically connected by means of the link module.
- Auxiliary switches²⁾ on the motor starter protector and the contactor can be easily fitted thanks to the modular system.
- With contactor sizes S0, S2 and S3, an integrated NO contact is still available for free use.

Size	Standard three-phase motor 4-pole at 400 V AC ³⁾	Adjustable current response value of the inverse-time delayed overload release	Comprising the following single devices			SD	Fuseless load feeder	PU (UNIT, SET, M)	PS*	PG
	Standard output P	Motor current I (guide value)	Motor starter protector	+ 2 contactors	+ Link module + Assembly kit RH ⁴⁾ /Wiring kit		Screw terminals			
	kW	A	A			d	Article No.	Basic price per PU		

Type of coordination "2" at $I_{ca} = 150 \text{ kA}$ at 400 V (also compatible with type of coordination "1")

				3RV20	3RT20	3RA						
								ToC 2				
S00	0.06	0.2	0.14 ... 0.2	11-0BA10	15-1BB42	1921-1DA00	2	3RA2210-0BA15-2BB4	1	1 unit	41D	
	0.06	0.2	0.18 ... 0.25	11-0CA10		+ 2913-2AA1	2	3RA2210-0CA15-2BB4	1	1 unit	41D	
	0.09	0.3	0.22 ... 0.32	11-0DA10			2	3RA2210-0DA15-2BB4	1	1 unit	41D	
	0.09	0.3	0.28 ... 0.4	11-0EA10			2	3RA2210-0EA15-2BB4	1	1 unit	41D	
	0.12	0.4	0.35 ... 0.5	11-0FA10			2	3RA2210-0FA15-2BB4	1	1 unit	41D	
	0.18	0.6	0.45 ... 0.63	11-0GA10			2	3RA2210-0GA15-2BB4	1	1 unit	41D	
	0.18	0.6	0.55 ... 0.8	11-0HA10			2	3RA2210-0HA15-2BB4	1	1 unit	41D	
	0.25	0.85	0.7 ... 1	11-0JA10			2	3RA2210-0JA15-2BB4	1	1 unit	41D	
	0.37	1.1	0.9 ... 1.25	11-0KA10			2	3RA2210-0KA15-2BB4	1	1 unit	41D	
	0.55	1.5	1.1 ... 1.6	11-1AA10			2	3RA2210-1AA15-2BB4	1	1 unit	41D	
	0.75	1.9	1.4 ... 2	11-1BA10			2	3RA2210-1BA15-2BB4	1	1 unit	41D	
	0.75	1.9	1.8 ... 2.5	11-1CA10			2	3RA2210-1CA15-2BB4	1	1 unit	41D	
	1.1	2.7	2.2 ... 3.2	11-1DA10			2	3RA2210-1DA15-2BB4	1	1 unit	41D	
	1.5	3.6	2.8 ... 4	11-1EA10			2	3RA2210-1EA15-2BB4	1	1 unit	41D	
S0	1.5	3.6	3.5 ... 5	11-1FA10	24-1BB40	2921-1BA00	2	3RA2220-1FB24-0BB4	1	1 unit	41D	
	2.2	4.9	4.5 ... 6.3	11-1GA10		+ 2923-1BB1	2	3RA2220-1GB24-0BB4	1	1 unit	41D	
	3	6.5	5.5 ... 8	11-1HA10			2	3RA2220-1HB24-0BB4	1	1 unit	41D	
	4	8.5	7 ... 10	11-1JA10			2	3RA2220-1JB24-0BB4	1	1 unit	41D	
	5.5	11.5	9 ... 12	11-1KA10			2	3RA2220-1KB24-0BB4	1	1 unit	41D	
	7.5	15.5	10 ... 16	21-4AA10	26-1BB40		2	3RA2220-4AB26-0BB4	1	1 unit	41D	
	7.5	15.5	13 ... 20	21-4BA10	27-1BB40		5	3RA2220-4BB27-0BB4	1	1 unit	41D	
	11	22	16 ... 22	21-4CA10			2	3RA2220-4CB27-0BB4	1	1 unit	41D	
	11	22	18 ... 25	21-4DA10			2	3RA2220-4DB27-0BB4	1	1 unit	41D	
	15	28	23 ... 28	21-4NA10			2	3RA2220-4NB27-0BB4	1	1 unit	41D	
	15	29 ⁵⁾	27 ... 32	21-4EA10			2	3RA2220-4EB27-0BB4	1	1 unit	41D	
S2	15	29	22 ... 32	32-4EA10	35-1NB30	2931-1AA00		Size S2 is only available for self-assembly.				
	18.5	35	28 ... 36	32-4PA10		+ 2933-1BB1						
	18.5	35	32 ... 40	32-4UA10								
	22	41	35 ... 45	32-4VA10	36-1NB30							
	22	41	42 ... 50	32-4WA10								
	30	55	49 ... 59	32-4XA10	37-1NB30							
	30	55	54 ... 65	32-4JA10								
	37 ⁶⁾	66	62 ... 73	32-4KA10	38-1NB30							
S3	Size S3 available on request						Size S3 is only available for self-assembly.					

¹⁾ For push-in lugs, see "Accessories" on page 8/51.

²⁾ For auxiliary switches, see "Accessories" on page 8/44.

³⁾ The actual starting and rated data of the motor to be protected must be considered when selecting the units.

⁴⁾ RH = assembly kit for reversing duty and standard rail mounting in sizes S0 and S2.

⁵⁾ Suitable for use with IE3/IE4 motors up to a starting current of 256 A. For higher starting currents we recommend using size S2.

⁶⁾ Maximum permissible current setting at motor starter protector 65 A, as the maximum permissible current of the 3RA2931-1AA00 link module is 65 A.

Load Feeders and Motor Starters for Use in the Control Cabinet

SIRIUS 3RA2 Load Feeders

IE3/IE4 ready 3RA22 reversing starters > for standard mounting rails or for screw fixing



3RA2210

Reversing duty

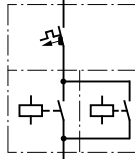

Rated control supply voltage 24 V DC With screw terminals

- Screw fixing with two push-in lugs per load feeder possible¹⁾
- Without standard mounting rail adapter for size S00
- The motor starter protector and contactor are mechanically and electrically connected by means of the link module.
- Auxiliary switches²⁾ on the motor starter protector and the contactor can be easily fitted thanks to the modular system.

Size	Standard three-phase motor 4-pole at 400 V AC ³⁾	Adjustable current response value of the inverse-time delayed overload release	Comprising the following single devices			SD	Fuseless load feeder	PU (UNIT, SET, M)	PS*	PG
	Stand-ard output P	Motor current I (guide value)	Motor starter protector	+ 2 contactors	+ Link module + Wiring kit		Screw terminals			
							Article No.	Basic price per PU		
	kW	A	A			d				

Type of coordination "1" at $I_q = 150$ kA at 400 V
(motor starter protector is compatible with type of coordination "2")

				3RV20	3RT20	3RA				
S00	For load feeders for lower outputs, see this table at type of coordination "2".									
1.5	3.6	3.5 ... 5	11-1FA10	15-1BB42	1921-1DA00	2	3RA2210-1FA15-2BB4	1	1 unit	41D
2.2	4.9	4.5 ... 6.3	11-1GA10		+ 2913-2AA1	2	3RA2210-1GA15-2BB4	1	1 unit	41D
3	6.5	5.5 ... 8	11-1HA10			2	3RA2210-1HA15-2BB4	1	1 unit	41D
4	8.5	7 ... 10	11-1JA10	16-1BB42		2	3RA2210-1JA16-2BB4	1	1 unit	41D
5.5	11.5	9 ... 12	11-1KA10	17-1BB42		2	3RA2210-1KA17-2BB4	1	1 unit	41D
7.5	15.5	10 ... 16	11-4AA10	18-1BB42		2	3RA2210-4AA18-2BB4	1	1 unit	41D

¹⁾ For push-in lugs, see "Accessories" on page 8/51.

²⁾ For auxiliary switches, see "Accessories" on page 8/44.

³⁾ The actual starting and rated data of the motor to be protected must be considered when selecting the units.

Load Feeders and Motor Starters for Use in the Control Cabinet

SIRIUS 3RA2 Load Feeders

3RA22 reversing starters > for standard mounting rails or for screw fixing **IE3/IE4 ready**



3RA2210

3RA2220

Reversing duty

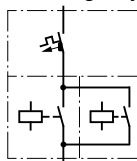

Rated control supply voltage 24 V DC With spring-loaded terminals

- Screw fixing with two push-in lugs per load feeder possible¹⁾
- Without standard mounting rail adapter for size S00
- With two standard mounting rail adapters for size S0 for mechanical reinforcement (included in the scope of supply)
- The motor starter protector and contactor are mechanically and electrically connected by means of the link module.
- Auxiliary switches²⁾ on the motor starter protector and the contactor can be easily fitted thanks to the modular system.
- With the contactor S0, an integrated NO contact is still available for free use.

Size	Standard three-phase motor 4-pole at 400 V AC ³⁾	Adjustable current response value of the inverse-time delayed overload release	Comprising the following single devices			SD	Fuseless load feeder	PU (UNIT, SET, M)	PS*	PG
	Standard output P	Motor current I (guide value)	Motor starter protector	+ 2 contactors	+ Link module + Assembly kit RS ⁴⁾ /Wiring kit		Spring-loaded terminals			
	kW	A	A			d	Article No.	Basic price per PU		

Type of coordination "2" at $I_q = 150$ kA at 400 V (also compatible with type of coordination "1")

			3RV20	3RT20	3RA29						
S00	0.06	0.2	0.14 ... 0.2	11-0BA20	15-2BB42	11-2AA00	2	3RA2210-0BE15-2BB4	1	1 unit	41D
	0.06	0.2	0.18 ... 0.25	11-0CA20		+ 13-2AA2	2	3RA2210-0CE15-2BB4	1	1 unit	41D
	0.09	0.3	0.22 ... 0.32	11-0DA20			2	3RA2210-0DE15-2BB4	1	1 unit	41D
	0.09	0.3	0.28 ... 0.4	11-0EA20			2	3RA2210-0EE15-2BB4	1	1 unit	41D
	0.12	0.4	0.35 ... 0.5	11-0FA20			2	3RA2210-0FE15-2BB4	1	1 unit	41D
	0.18	0.6	0.45 ... 0.63	11-0GA20			2	3RA2210-0GE15-2BB4	1	1 unit	41D
	0.18	0.6	0.55 ... 0.8	11-0HA20			2	3RA2210-0HE15-2BB4	1	1 unit	41D
	0.25	0.85	0.7 ... 1	11-0JA20			2	3RA2210-0JE15-2BB4	1	1 unit	41D
	0.37	1.1	0.9 ... 1.25	11-0KA20			2	3RA2210-0KE15-2BB4	1	1 unit	41D
	0.55	1.5	1.1 ... 1.6	11-1AA20			2	3RA2210-1AE15-2BB4	1	1 unit	41D
	0.75	1.9	1.4 ... 2	11-1BA20			2	3RA2210-1BE15-2BB4	1	1 unit	41D
	0.75	1.9	1.8 ... 2.5	11-1CA20			2	3RA2210-1CE15-2BB4	1	1 unit	41D
	1.1	2.7	2.2 ... 3.2	11-1DA20			2	3RA2210-1DE15-2BB4	1	1 unit	41D
	1.5	3.6	2.8 ... 4	11-1EA20			2	3RA2210-1EE15-2BB4	1	1 unit	41D
S0	1.5	3.6	3.5 ... 5	21-1FA20	24-2BB40	21-2AA00	5	3RA2220-1FF24-0BB4	1	1 unit	41D
	2.2	4.9	4.5 ... 6.3	21-1GA20		+ 23-1BB2	5	3RA2220-1GF24-0BB4	1	1 unit	41D
	3	6.5	5.5 ... 8	21-1HA20			5	3RA2220-1HF24-0BB4	1	1 unit	41D
	4	8.5	7 ... 10	21-1JA20			5	3RA2220-1JF24-0BB4	1	1 unit	41D
	5.5	11.5	9 ... 12	21-1KA20			5	3RA2220-1KF24-0BB4	1	1 unit	41D
	7.5	15.5	10 ... 16	21-4AA20	26-2BB40		2	3RA2220-4AF26-0BB4	1	1 unit	41D
	7.5	15.5	13 ... 20	21-4BA20	27-2BB40		5	3RA2220-4BF27-0BB4	1	1 unit	41D
	11	22	16 ... 22	21-4CA20			2	3RA2220-4CF27-0BB4	1	1 unit	41D
	11	22	18 ... 25	21-4DA20			2	3RA2220-4DF27-0BB4	1	1 unit	41D
	15	28	23 ... 28	21-4NA20			2	3RA2220-4NF27-0BB4	1	1 unit	41D
	15	29 ⁵⁾	27 ... 32	21-4EA20			2	3RA2220-4EF27-0BB4	1	1 unit	41D

Type of coordination "1" at $I_q = 150$ kA at 400 V (motor starter protector is compatible with type of coordination "2")

S00	For load feeders for lower outputs, see this table at type of coordination "2".										
	1.5	3.6	3.5 ... 5	11-1FA20	15-2BB42	11-2AA00	2	3RA2210-1FE15-2BB4	1	1 unit	41D
	2.2	4.9	4.5 ... 6.3	11-1GA20		+ 13-2AA2	2	3RA2210-1GE15-2BB4	1	1 unit	41D
	3	6.5	5.5 ... 8	11-1HA20			2	3RA2210-1HE15-2BB4	1	1 unit	41D
	4	8.5	7 ... 10	11-1JA20	16-2BB42		2	3RA2210-1JE16-2BB4	1	1 unit	41D
	5.5	11.5	9 ... 12	11-1KA20	17-2BB42		2	3RA2210-1KE17-2BB4	1	1 unit	41D
	7.5	15.5	10 ... 16	11-4AA20	18-2BB42		2	3RA2210-4AE18-2BB4	1	1 unit	41D

¹⁾ For push-in lugs, see "Accessories" on page 8/51.

²⁾ For auxiliary switches, see "Accessories" on page 8/44.

³⁾ The actual starting and rated data of the motor to be protected must be considered when selecting the units.

⁴⁾ RH = assembly kit for reversing duty and standard rail mounting in size S0.

⁵⁾ Suitable for use with IE3/IE4 motors up to a starting current of 256 A. For higher starting currents we recommend using size S2.

Load Feeders and Motor Starters for Use in the Control Cabinet

SIRIUS 3RA2 Load Feeders

IE3/IE4 ready 3RA22 reversing starters > for 60 mm busbars

Selection and ordering data



3RA2210

3RA2220

Reversing duty

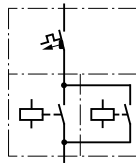

Rated control supply voltage

50/60 Hz 230 V AC for S00, 50 Hz 230 V AC for S0 and S2
With screw terminals

- With busbar adapter and device holder (included in the scope of supply)
- The motor starter protector and contactor are mechanically and electrically connected by means of the link module.
- Auxiliary switches¹⁾ on the motor starter protector and the contactor can be easily fitted thanks to the modular system.
- With contactor sizes S0 and S2, an integrated NO contact is still available for free use.

Size	Standard three-phase motor 4-pole at 400 V AC ²⁾		Adjustable current response value of the inverse-time delayed overload release	Comprising the following single devices			SD	Fuseless load feeder	PU (UNIT, SET, M)	PS*	PG
	Standard output P	Motor current I (guide value)		Motor starter protector	+ 2 contactors	+ Link module + Assembly kit RS ³⁾ / Wiring kit					
	kW	A	A								
							Article No.		Basic price per PU		

Type of coordination "2" at $I_q = 150$ kA at 400 V
 (also compatible with type of coordination "1")

	3RV20			3RT20		3RA		ToC 2					
S00	0.06	0.2	0.14 ... 0.2	11-0BA10	15-1AP02	1921-1DA00	2	3RA2210-0BD15-2AP0 3RA2210-0CD15-2AP0 3RA2210-0DD15-2AP0 3RA2210-0ED15-2AP0 3RA2210-0FD15-2AP0 3RA2210-0GD15-2AP0 3RA2210-0HD15-2AP0 3RA2210-0JD15-2AP0 3RA2210-0KD15-2AP0 3RA2210-1AD15-2AP0 3RA2210-1BD15-2AP0 3RA2210-1CD15-2AP0 3RA2210-1DD15-2AP0 3RA2210-1ED15-2AP0	1	1 unit	41D		
	0.06	0.2	0.18 ... 0.25	11-0CA10		+ 2913-1DB1	2		1	1 unit	41D		
	0.09	0.3	0.22 ... 0.32	11-0DA10			2		1	1 unit	41D		
	0.09	0.3	0.28 ... 0.4	11-0EA10			2		1	1 unit	41D		
	0.12	0.4	0.35 ... 0.5	11-0FA10			2		1	1 unit	41D		
	0.18	0.6	0.45 ... 0.63	11-0GA10			2		1	1 unit	41D		
	0.18	0.6	0.55 ... 0.8	11-0HA10			2		1	1 unit	41D		
	0.25	0.85	0.7 ... 1	11-0JA10			2		1	1 unit	41D		
	0.37	1.1	0.9 ... 1.25	11-0KA10			2		1	1 unit	41D		
	0.55	1.5	1.1 ... 1.6	11-1AA10			2		1	1 unit	41D		
	0.75	1.9	1.4 ... 2	11-1BA10			2		1	1 unit	41D		
	0.75	1.9	1.8 ... 2.5	11-1CA10			2		1	1 unit	41D		
	1.1	2.7	2.2 ... 3.2	11-1DA10			2		1	1 unit	41D		
	1.5	3.6	2.8 ... 4	11-1EA10			2		1	1 unit	41D		
	S0	1.5	3.6	3.5 ... 5	11-1FA10	24-1AP00	2921-1AA00		2	3RA2220-1FD24-0AP0 3RA2220-1GD24-0AP0 3RA2220-1HD24-0AP0 3RA2220-1JD24-0AP0 3RA2220-1KD24-0AP0 3RA2220-4AD26-0AP0 3RA2220-4BD27-0AP0 3RA2220-4CD27-0AP0 3RA2220-4DD27-0AP0 3RA2220-4ND27-0AP0 3RA2220-4ED27-0AP0	1	1 unit	41D
		2.2	4.9	4.5 ... 6.3	11-1GA10		+ 2923-1DB1		2		1	1 unit	41D
3		6.5	5.5 ... 8	11-1HA10			2	1	1 unit		41D		
4		8.5	7 ... 10	11-1JA10			2	1	1 unit		41D		
5.5		11.5	9 ... 12	11-1KA10			2	1	1 unit		41D		
7.5		15.5	10 ... 16	21-4AA10	26-1AP00		2	1	1 unit		41D		
7.5		15.5	13 ... 20	21-4BA10	27-1AP00		5	1	1 unit		41D		
11		22	16 ... 22	21-4CA10			2	1	1 unit		41D		
11		22	18 ... 25	21-4DA10			2	1	1 unit		41D		
15		28	23 ... 28	21-4NA10			2	1	1 unit		41D		
15		29 ⁴⁾	27 ... 32	21-4EA10			2	1	1 unit		41D		
S2		15	29	22 ... 32	32-4EA10	35-1AP00	2931-1AA00	Size S2 is only available for self-assembly.					
		18.5	35	28 ... 36	32-4PA10		+ 2933-1DB1						
		18.5	35	32 ... 40	32-4UA10								
	22	41	35 ... 45	32-4VA10	36-1AP00								
	22	41	42 ... 50	32-4WA10									
	30	55	49 ... 59	32-4XA10	37-1AP00								
	30	55	54 ... 65	32-4JA10									
	37 ⁵⁾	66	62 ... 73	32-4KA10	38-1AP00								

¹⁾ For auxiliary switches, see "Accessories" on page 8/44.

²⁾ The actual starting and rated data of the motor to be protected must be considered when selecting the units.

³⁾ RS = assembly kit for reversing duty and busbar mounting.

⁴⁾ Suitable for use with IE3/IE4 motors up to a starting current of 256 A. For higher starting currents we recommend using size S2.

⁵⁾ Maximum permissible current setting at motor starter protector 65 A, as the maximum permissible current of the 3RA2931-1AA00 link module is 65 A.

Load Feeders and Motor Starters for Use in the Control Cabinet

SIRIUS 3RA2 Load Feeders

3RA22 reversing starters > for 60 mm busbars **IE3/IE4 ready**



3RA2210

Reversing duty

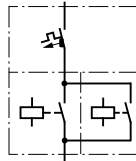

Rated control supply voltage 50/60 Hz 230 V AC for S00 With screw terminals

- With busbar adapter and device holder (included in the scope of supply)
- The motor starter protector and contactor are mechanically and electrically connected by means of the link module.
- Auxiliary switches¹⁾ on the motor starter protector and the contactor can be easily fitted thanks to the modular system.

Size	Standard three-phase motor 4-pole at 400 V AC ²⁾	Adjustable current response value of the inverse-time delayed overload release	Comprising the following single devices			SD	Fuseless load feeder	PU (UNIT, SET, M)	PS*	PG
	Stand-ard output <i>P</i>	Motor current <i>I</i> (guide value)	Motor starter protector	+ 2 contactors	+ Link module + Assembly kit RS ³⁾ / Wiring kit		Screw terminals			
	kW	A	A			d	Article No.	Basic price per PU		

Type of coordination "1" at $I_q = 150$ kA at 400 V
(motor starter protector is compatible with type of coordination "2")

3RV20 3RT20 3RA

S00	For load feeders for lower outputs, see this table at type of coordination "2".									
1.5	3.6	3.5 ... 5	11-1FA10	15-1AP02	1921-1DA00	2	3RA2210-1FD15-2AP0	1	1 unit	41D
2.2	4.9	4.5 ... 6.3	11-1GA10		+ 2913-1DB1	2	3RA2210-1GD15-2AP0	1	1 unit	41D
3	6.5	5.5 ... 8	11-1HA10			2	3RA2210-1HD15-2AP0	1	1 unit	41D
4	8.5	7 ... 10	11-1JA10	16-1AP02		2	3RA2210-1JD16-2AP0	1	1 unit	41D
5.5	11.5	9 ... 12	11-1KA10	17-1AP02		2	3RA2210-1KD17-2AP0	1	1 unit	41D
7.5	15.5	10 ... 16	11-4AA10	18-1AP02		2	3RA2210-4AD18-2AP0	1	1 unit	41D

¹⁾ For auxiliary switches, see "Accessories" on page 8/44.

²⁾ The actual starting and rated data of the motor to be protected must be considered when selecting the units.

³⁾ RS = Assembly kit for reversing duty and busbar mounting.

Load Feeders and Motor Starters for Use in the Control Cabinet

SIRIUS 3RA2 Load Feeders

IE3/IE4 ready 3RA22 reversing starters > for 60 mm busbars

3RA2210

3RA2220

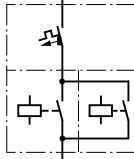
Reversing duty

Rated control supply voltage
50/60 Hz 230 V AC for S00, 50 Hz 230 V AC for S0
With spring-loaded terminals

- With busbar adapter and device holder (included in the scope of supply)
- The motor starter protector and contactor are mechanically and electrically connected by means of the link module.
- Auxiliary switches¹⁾ on the motor starter protector and the contactor can be easily fitted thanks to the modular system.
- With the contactor S0, an integrated NO contact is still available for free use.

Size	Standard three-phase motor 4-pole at 400 V AC ²⁾	Adjustable current response value of the inverse-time delayed overload release	Comprising the following single devices			SD	Fuseless load feeder	PU (UNIT, SET, M)	PS*	PG
	Standard output P	Motor current I (guide value)	Motor starter protector	+ 2 contactors	+ Link module + Assembly kit RS ³⁾ /Wiring kit		Spring-loaded terminals			
	kW	A	A			d	Article No.	Basic price per PU		

Type of coordination "2" at $I_q = 150$ kA at 400 V
 (also compatible with type of coordination "1")

				3RV20	3RT20	3RA29						
S00	0.06	0.2	0.14 ... 0.2	11-0BA20	15-2AP02	11-2AA00	2	3RA2210-0BH15-2AP0	1	1 unit	41D	
	0.06	0.2	0.18 ... 0.25	11-0CA20		+ 13-1DB2	2	3RA2210-0CH15-2AP0	1	1 unit	41D	
	0.09	0.3	0.22 ... 0.32	11-0DA20			2	3RA2210-0DH15-2AP0	1	1 unit	41D	
	0.09	0.3	0.28 ... 0.4	11-0EA20			2	3RA2210-0EH15-2AP0	1	1 unit	41D	
	0.12	0.4	0.35 ... 0.5	11-0FA20			2	3RA2210-0FH15-2AP0	1	1 unit	41D	
	0.18	0.6	0.45 ... 0.63	11-0GA20			2	3RA2210-0GH15-2AP0	1	1 unit	41D	
	0.18	0.6	0.55 ... 0.8	11-0HA20			2	3RA2210-0HH15-2AP0	1	1 unit	41D	
	0.25	0.85	0.7 ... 1	11-0JA20			2	3RA2210-0JH15-2AP0	1	1 unit	41D	
	0.37	1.1	0.9 ... 1.25	11-0KA20			2	3RA2210-0KH15-2AP0	1	1 unit	41D	
	0.55	1.5	1.1 ... 1.6	11-1AA20			2	3RA2210-1AH15-2AP0	1	1 unit	41D	
	0.75	1.9	1.4 ... 2	11-1BA20			2	3RA2210-1BH15-2AP0	1	1 unit	41D	
	0.75	1.9	1.8 ... 2.5	11-1CA20			2	3RA2210-1CH15-2AP0	1	1 unit	41D	
	1.1	2.7	2.2 ... 3.2	11-1DA20			2	3RA2210-1DH15-2AP0	1	1 unit	41D	
	1.5	3.6	2.8 ... 4	11-1EA20			2	3RA2210-1EH15-2AP0	1	1 unit	41D	
S0	1.5	3.6	3.5 ... 5	21-1FA20	24-2AP00	21-2AA00	5	3RA2220-1FH24-0AP0	1	1 unit	41D	
	2.2	4.9	4.5 ... 6.3	21-1GA20		+ 23-1DB2 ⁴⁾	5	3RA2220-1GH24-0AP0	1	1 unit	41D	
	3	6.5	5.5 ... 8	21-1HA20			5	3RA2220-1HH24-0AP0	1	1 unit	41D	
	4	8.5	7 ... 10	21-1JA20			5	3RA2220-1JH24-0AP0	1	1 unit	41D	
	5.5	11.5	9 ... 12	21-1KA20			5	3RA2220-1KH24-0AP0	1	1 unit	41D	
	7.5	15.5	10 ... 16	21-4AA20	26-2AP00		2	3RA2220-4AH26-0AP0	1	1 unit	41D	
	7.5	15.5	13 ... 20	21-4BA20	27-2AP00		5	3RA2220-4BH27-0AP0	1	1 unit	41D	
	11	22	16 ... 22	21-4CA20			2	3RA2220-4CH27-0AP0	1	1 unit	41D	
	11	22	18 ... 25	21-4DA20			2	3RA2220-4DH27-0AP0	1	1 unit	41D	
	15	28	23 ... 28	21-4NA20			2	3RA2220-4NH27-0AP0	1	1 unit	41D	
	15	29 ⁵⁾	27 ... 32	21-4EA20			2	3RA2220-4EH27-0AP0	1	1 unit	41D	

Type of coordination "1" at $I_q = 150$ kA at 400 V
 (motor starter protector is compatible with type of coordination "2")

S00	For load feeders for lower outputs, see this table at type of coordination "2".											
	1.5	3.6	3.5 ... 5	11-1FA20	15-2AP02	11-2AA00	2	3RA2210-1FH15-2AP0	1	1 unit	41D	
	2.2	4.9	4.5 ... 6.3	11-1GA20		+ 13-1DB2	2	3RA2210-1GH15-2AP0	1	1 unit	41D	
	3	6.5	5.5 ... 8	11-1HA20			2	3RA2210-1HH15-2AP0	1	1 unit	41D	
	4	8.5	7 ... 10	11-1JA20	16-2AP02		2	3RA2210-1JH16-2AP0	1	1 unit	41D	
	5.5	11.5	9 ... 12	11-1KA20	17-2AP02		2	3RA2210-1KH17-2AP0	1	1 unit	41D	
	7.5	15.5	10 ... 16	11-4AA20	18-2AP02		2	3RA2210-4AH18-2AP0	1	1 unit	41D	

¹⁾ For auxiliary switches, see "Accessories" on page 8/44.

²⁾ The actual starting and rated data of the motor to be protected must be considered when selecting the units.

³⁾ RS = Assembly kit for reversing duty and busbar mounting.

⁴⁾ The RS assembly kit also includes the 3RA2911-1CA00 spacer for height compensation on AC contactors size S0 with spring-loaded terminals.

⁵⁾ Suitable for use with IE3/IE4 motors up to a starting current of 256 A. For higher starting currents we recommend using size S2.

Load Feeders and Motor Starters for Use in the Control Cabinet

SIRIUS 3RA2 Load Feeders

3RA22 reversing starters > for 60 mm busbars **IE3/IE4 ready**

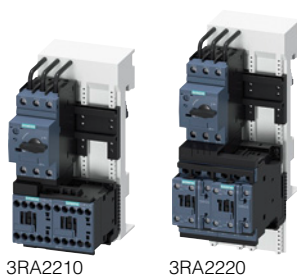

Reversing duty

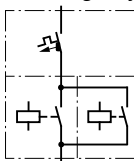

Rated control supply voltage 24 V DC With screw terminals

- With busbar adapter and device holder (included in the scope of supply)
- The motor starter protector and contactor are mechanically and electrically connected by means of the link module.
- Auxiliary switches¹⁾ on the motor starter protector and the contactor can be easily fitted thanks to the modular system.
- With contactor sizes S0 and S2, an integrated NO contact is still available for free use.

Size	Standard three-phase motor 4-pole at 400 V AC ²⁾	Adjustable current response value of the inverse-time delayed overload release	Comprising the following single devices			SD	Fuseless load feeder	PU (UNIT, SET, M)	PS*	PG
	Standard output P	Motor current I (guide value)	Motor starter protector	+ 2 contactors	+ Link module + Assembly kit RS ³⁾ / Wiring kit		Screw terminals			
	kW	A	A			d	Article No.	Basic price per PU		

Type of coordination "2" at $I_q = 150$ kA at 400 V (also compatible with type of coordination "1")

				3RV20	3RT20	3RA						
								ToC 2				
S00	0.06	0.2	0.14 ... 0.2	11-0BA10	15-1BB42	1921-1DA00	2	3RA2210-0BD15-2BB4	1	1 unit	41D	
	0.06	0.2	0.18 ... 0.25	11-0CA10		+ 2913-1DB1	2	3RA2210-0CD15-2BB4	1	1 unit	41D	
	0.09	0.3	0.22 ... 0.32	11-0DA10			2	3RA2210-0DD15-2BB4	1	1 unit	41D	
	0.09	0.3	0.28 ... 0.4	11-0EA10			2	3RA2210-0ED15-2BB4	1	1 unit	41D	
	0.12	0.4	0.35 ... 0.5	11-0FA10			2	3RA2210-0FD15-2BB4	1	1 unit	41D	
	0.18	0.6	0.45 ... 0.63	11-0GA10			2	3RA2210-0GD15-2BB4	1	1 unit	41D	
	0.18	0.6	0.55 ... 0.8	11-0HA10			2	3RA2210-0HD15-2BB4	1	1 unit	41D	
	0.25	0.85	0.7 ... 1	11-0JA10			2	3RA2210-0JD15-2BB4	1	1 unit	41D	
	0.37	1.1	0.9 ... 1.25	11-0KA10			2	3RA2210-0KD15-2BB4	1	1 unit	41D	
	0.55	1.5	1.1 ... 1.6	11-1AA10			2	3RA2210-1AD15-2BB4	1	1 unit	41D	
	0.75	1.9	1.4 ... 2	11-1BA10			2	3RA2210-1BD15-2BB4	1	1 unit	41D	
	0.75	1.9	1.8 ... 2.5	11-1CA10			2	3RA2210-1CD15-2BB4	1	1 unit	41D	
	1.1	2.7	2.2 ... 3.2	11-1DA10			2	3RA2210-1DD15-2BB4	1	1 unit	41D	
	1.5	3.6	2.8 ... 4	11-1EA10			2	3RA2210-1ED15-2BB4	1	1 unit	41D	
S0	1.5	3.6	3.5 ... 5	11-1FA10	24-1BB40	2921-1BA00	2	3RA2220-1FD24-0BB4	1	1 unit	41D	
	2.2	4.9	4.5 ... 6.3	11-1GA10		+ 2923-1DB1	2	3RA2220-1GD24-0BB4	1	1 unit	41D	
	3	6.5	5.5 ... 8	11-1HA10			2	3RA2220-1HD24-0BB4	1	1 unit	41D	
	4	8.5	7 ... 10	11-1JA10			2	3RA2220-1JD24-0BB4	1	1 unit	41D	
	5.5	11.5	9 ... 12	11-1KA10			2	3RA2220-1KD24-0BB4	1	1 unit	41D	
	7.5	15.5	10 ... 16	21-4AA10	26-1BB40		2	3RA2220-4AD26-0BB4	1	1 unit	41D	
	7.5	15.5	13 ... 20	21-4BA10	27-1BB40		5	3RA2220-4BD27-0BB4	1	1 unit	41D	
	11	22	16 ... 22	21-4CA10			2	3RA2220-4CD27-0BB4	1	1 unit	41D	
	11	22	18 ... 25	21-4DA10			2	3RA2220-4DD27-0BB4	1	1 unit	41D	
	15	28	23 ... 28	21-4NA10			2	3RA2220-4ND27-0BB4	1	1 unit	41D	
	15	29 ⁴⁾	27 ... 32	21-4EA10			2	3RA2220-4ED27-0BB4	1	1 unit	41D	
S2	15	29	22 ... 32	32-4EA10	35-1NB30	2931-1AA00		Size S2 is only available for self-assembly.				
	18.5	35	28 ... 36	32-4PA10		+ 2933-1DB1						
	18.5	35	32 ... 40	32-4UA10								
	22	41	35 ... 45	32-4VA10	36-1NB30							
	22	41	42 ... 50	32-4WA10								
	30	55	49 ... 59	32-4XA10	37-1NB30							
	30	55	54 ... 65	32-4JA10								
	37 ⁵⁾	66	62 ... 73	32-4KA10	38-1NB30							

Type of coordination "1" at $I_q = 150$ kA at 400 V (motor starter protector is compatible with type of coordination "2")

S00	For load feeders for lower outputs, see this table at type of coordination "2".											
	1.5	3.6	3.5 ... 5	11-1FA10	15-1BB42	1921-1DA00	2	3RA2210-1FD15-2BB4	1	1 unit	41D	
	2.2	4.9	4.5 ... 6.3	11-1GA10		+ 2913-1DB1	2	3RA2210-1GD15-2BB4	1	1 unit	41D	
	3	6.5	5.5 ... 8	11-1HA10			2	3RA2210-1HD15-2BB4	1	1 unit	41D	
	4	8.5	7 ... 10	11-1JA10	16-1BB42		2	3RA2210-1JD16-2BB4	1	1 unit	41D	
	5.5	11.5	9 ... 12	11-1KA10	17-1BB42		2	3RA2210-1KD17-2BB4	1	1 unit	41D	
	7.5	15.5	10 ... 16	11-4AA10	18-1BB42		2	3RA2210-4AD18-2BB4	1	1 unit	41D	

¹⁾ For auxiliary switches, see "Accessories" on page 8/44.

²⁾ The actual starting and rated data of the motor to be protected must be considered when selecting the units.

³⁾ RS = Assembly kit for reversing duty and busbar mounting.

⁴⁾ Suitable for use with IE3/IE4 motors up to a starting current of 256 A. For higher starting currents we recommend using size S2.

⁵⁾ Maximum permissible current setting at motor starter protector 65 A, as the maximum permissible current of the 3RA2931-1AA00 link module is 65 A.

Load Feeders and Motor Starters for Use in the Control Cabinet

SIRIUS 3RA2 Load Feeders

IE3/IE4 ready

3RA22 reversing starters > for 60 mm busbars

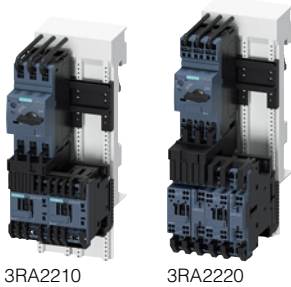

3RA2210

3RA2220

Reversing duty

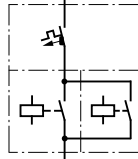
Rated control supply voltage 24 V DC
With spring-loaded terminals

- With busbar adapter and device holder (included in the scope of supply)
- The motor starter protector and contactor are mechanically and electrically connected by means of the link module.
- Auxiliary switches¹⁾ on the motor starter protector and the contactor can be easily fitted thanks to the modular system.
- With the contactor S0, an integrated NO contact is still available for free use.

Size	Standard three-phase motor 4-pole at 400 V AC ²⁾	Adjustable current response value of the inverse-time delayed overload release	Comprising the following single devices			SD	Fuseless load feeder	PU (UNIT, SET, M)	PS*	PG
	Standard output P	Motor current I (guide value)	Motor starter protector	+ 2 contactors	+ Link module + Assembly kit RS ³⁾ / Wiring kit		Spring-loaded terminals			
	kW	A	A			d	Article No.	Basic price per PU		

Type of coordination "2" at $I_q = 150$ kA at 400 V
 (also compatible with type of coordination "1")

				3RV20	3RT20	3RA29						
S00	0.06	0.2	0.14 ... 0.2	11-0BA20	15-2BB42	11-2AA00	2	3RA2210-0BH15-2BB4	1	1 unit	41D	
	0.06	0.2	0.18 ... 0.25	11-0CA20		+ 13-1DB2	2	3RA2210-0CH15-2BB4	1	1 unit	41D	
	0.09	0.3	0.22 ... 0.32	11-0DA20			2	3RA2210-0DH15-2BB4	1	1 unit	41D	
	0.09	0.3	0.28 ... 0.4	11-0EA20			2	3RA2210-0EH15-2BB4	1	1 unit	41D	
	0.12	0.4	0.35 ... 0.5	11-0FA20			2	3RA2210-0FH15-2BB4	1	1 unit	41D	
	0.18	0.6	0.45 ... 0.63	11-0GA20			2	3RA2210-0GH15-2BB4	1	1 unit	41D	
	0.18	0.6	0.55 ... 0.8	11-0HA20			2	3RA2210-0HH15-2BB4	1	1 unit	41D	
	0.25	0.85	0.7 ... 1	11-0JA20			2	3RA2210-0JH15-2BB4	1	1 unit	41D	
	0.37	1.1	0.9 ... 1.25	11-0KA20			2	3RA2210-0KH15-2BB4	1	1 unit	41D	
	0.55	1.5	1.1 ... 1.6	11-1AA20			2	3RA2210-1AH15-2BB4	1	1 unit	41D	
	0.75	1.9	1.4 ... 2	11-1BA20			2	3RA2210-1BH15-2BB4	1	1 unit	41D	
	0.75	1.9	1.8 ... 2.5	11-1CA20			2	3RA2210-1CH15-2BB4	1	1 unit	41D	
	1.1	2.7	2.2 ... 3.2	11-1DA20			2	3RA2210-1DH15-2BB4	1	1 unit	41D	
	1.5	3.6	2.8 ... 4	11-1EA20			2	3RA2210-1EH15-2BB4	1	1 unit	41D	
S0	1.5	3.6	3.5 ... 5	21-1FA20	24-2BB40	21-2AA00	5	3RA2220-1FH24-0BB4	1	1 unit	41D	
	2.2	4.9	4.5 ... 6.3	21-1GA20		+ 23-1DB2	5	3RA2220-1GH24-0BB4	1	1 unit	41D	
	3	6.5	5.5 ... 8	21-1HA20			5	3RA2220-1HH24-0BB4	1	1 unit	41D	
	4	8.5	7 ... 10	21-1JA20			5	3RA2220-1JH24-0BB4	1	1 unit	41D	
	5.5	11.5	9 ... 12	21-1KA20			5	3RA2220-1KH24-0BB4	1	1 unit	41D	
	7.5	15.5	10 ... 16	21-4AA20	26-2BB40		2	3RA2220-4AH26-0BB4	1	1 unit	41D	
	7.5	15.5	13 ... 20	21-4BA20	27-2BB40		5	3RA2220-4BH27-0BB4	1	1 unit	41D	
	11	22	16 ... 22	21-4CA20			2	3RA2220-4CH27-0BB4	1	1 unit	41D	
	11	22	18 ... 25	21-4DA20			2	3RA2220-4DH27-0BB4	1	1 unit	41D	
	15	28	23 ... 28	21-4NA20			2	3RA2220-4NH27-0BB4	1	1 unit	41D	
	15	29 ⁴⁾	27 ... 32	21-4EA20			2	3RA2220-4EH27-0BB4	1	1 unit	41D	

Type of coordination "1" at $I_q = 150$ kA at 400 V
 (motor starter protector is compatible with type of coordination "2")

S00	For load feeders for lower outputs, see this table at type of coordination "2".												
	1.5	3.6	3.5 ... 5	11-1FA20	15-2BB42	11-2AA00	2	3RA2210-1FH15-2BB4	1	1 unit	41D		
	2.2	4.9	4.5 ... 6.3	11-1GA20		+ 13-1DB2	2	3RA2210-1GH15-2BB4	1	1 unit	41D		
	3	6.5	5.5 ... 8	11-1HA20			2	3RA2210-1HH15-2BB4	1	1 unit	41D		
	4	8.5	7 ... 10	11-1JA20	16-2BB42		2	3RA2210-1JH16-2BB4	1	1 unit	41D		
	5.5	11.5	9 ... 12	11-1KA20	17-2BB42		2	3RA2210-1KH17-2BB4	1	1 unit	41D		
	7.5	15.5	10 ... 16	11-4AA20	18-2BB42		2	3RA2210-4AH18-2BB4	1	1 unit	41D		

¹⁾ For auxiliary switches, see "Accessories" on page 8/44.

²⁾ The actual starting and rated data of the motor to be protected must be considered when selecting the units.

³⁾ RS = Assembly kit for reversing duty and busbar mounting.

⁴⁾ Suitable for use with IE3/IE4 motors up to a starting current of 256 A. For higher starting currents we recommend using size S2.

Load Feeders and Motor Starters for Use in the Control Cabinet

SIRIUS 3RA2 Load Feeders

Accessories

Overview

The accessories listed here are parts and add-ons for the 3RA2 direct-on-line and reversing starters as well as components for the customer assembly of fuseless load feeders.

Selection and ordering data

Accessories for motor starter protectors

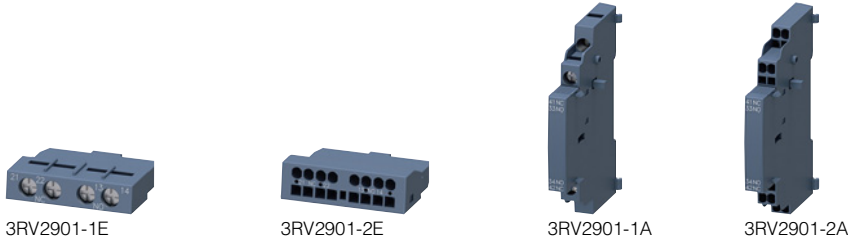

PU (UNIT, SET, M) = 1
PS* = 1 unit
PG = 41E

Version	For motor starter protectors	SD	Screw terminals	SD	Spring-loaded terminals	
Size		d	Article No.	Price per PU	Article No.	Price per PU
Auxiliary switches¹⁾						
Transverse auxiliary switches						
For front mounting						
1 CO	S00 ... S3	▶	3RV2901-1D	▶	--	▶
1 NO + 1 NC		▶	3RV2901-1E	▶	3RV2901-2E	▶
2 NO		▶	3RV2901-1F	▶	3RV2901-2F	▶
Lateral auxiliary switches						
For mounting on the left						
1 NO + 1 NC	S00 ... S3	▶	3RV2901-1A	▶	3RV2901-2A	▶

¹⁾ Each motor starter protector can be fitted with one transverse and one lateral auxiliary switch. The lateral auxiliary switches 2 NO + 2 NC are used without transverse auxiliary switches.

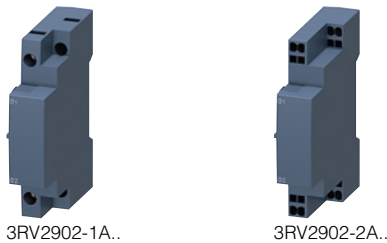

PU (UNIT, SET, M) = 1
PS* = 1 unit
PG = 41E

Rated control supply voltage U_s				For motor starter protectors	SD	Screw terminals	SD	Spring-loaded terminals	
AC 50 Hz	AC 60 Hz	AC 50/60 Hz	AC/DC 50/60 Hz, DC	Size	d	Article No.	Price per PU	Article No.	Price per PU
V	V	V	V						
		100% ON period ¹⁾	5 s ON period ²⁾						
Auxiliary releases for motor starter protectors³⁾									
Undervoltage release									
230	240	--	--	S00 ... S3	▶	3RV2902-1AP0	▶	3RV2902-2AP0	▶
Shunt release									
--	--	210 ... 240	190 ... 330	S00 ... S3	▶	3RV2902-1DP0	▶	3RV2902-2DP0	▶

- ¹⁾ The voltage range is valid for 100% (infinite) ON period. The response voltage is 0.9 of the lower limit of the voltage range.
- ²⁾ The voltage range is valid for 5 s ON period at 50/60 Hz AC and DC. The response voltage lies at 0.85 of the lower limit of the voltage range.
- ³⁾ One auxiliary release can be mounted on the right per motor starter protector (does not apply to 3RV21 motor starter protectors with overload relay function).







For the complete range of accessories for the motor starter protectors, see [page 7/43 onwards](#).

Load Feeders and Motor Starters for Use in the Control Cabinet

SIRIUS 3RA2 Load Feeders

Accessories

Accessories for contactors

For contactors	Version	SD	Article No.	Price per PU	PU (UNIT, SET, M)	PS*	PG
Size		d					
Auxiliary switches for snapping onto the front of contactors							
	Cable entry from below S00 ... S3	1-pole - 1 NO - 1 NC					
3RH2911-1BA..			▶ 3RH2911-1BA10 ▶ 3RH2911-1BA01		1 1	1 unit 1 unit	41B 41B
	S00 ... S3	2-pole - 1 NO + 1 NC - 2 NO					
3RH2911-1MA..			▶ 3RH2911-1MA11 ▶ 3RH2911-1MA20		1 1	1 unit 1 unit	41B 41B
Auxiliary switches for contactors, for lateral mounting							
	S00	2 NC	2	3RH2911-1DA02	1	1 unit	41B
	S00	1 NO + 1 NC	2	3RH2911-1DA11	1	1 unit	41B
	S00	2 NO	2	3RH2911-1DA20	1	1 unit	41B
	S0/S3	2 NC	2	3RH2921-1DA02	1	1 unit	41B
	S0/S3	1 NO + 1 NC	2	3RH2921-1DA11	1	1 unit	41B
	S0/S3	2 NO	2	3RH2921-1DA20	1	1 unit	41B
3RH2911-1DA..							
	S00	2 NC	2	3RH2911-2DA02	1	1 unit	41B
	S00	1 NO + 1 NC	2	3RH2911-2DA11	1	1 unit	41B
	S00	2 NO	2	3RH2911-2DA20	1	1 unit	41B
	S0/S3	2 NC	2	3RH2921-2DA02	1	1 unit	41B
	S0/S3	1 NO + 1 NC	2	3RH2921-2DA11	1	1 unit	41B
	S0/S3	2 NO	2	3RH2921-2DA20	1	1 unit	41B
3RH2911-2DA..							
Connection module (adapter and plug) for contactors with screw terminals (can only be used for direct-on-line starters)							
	The connection module comprises an adapter and a motor feeder connector.			Screw terminals			
	Adapters Ambient temperature $T_{U \text{ max.}} = 60 \text{ °C}$						
	S00	Rated operational current I_e at AC-3/400 V: 20 A	5	3RT1916-4RD01	1	1 unit	41B
3RT1926-4RD01							
	S0	Rated operational current I_e at AC-3/400 V: 25 A	5	3RT1926-4RD01	1	1 unit	41B
	Motor feeder connector						
	S00, S0	--	5	3RT1900-4RE01	1	1 unit	41B
3RT1900-4RE01							

For the complete range of accessories for the 3RT contactors, see [page 3/75 onwards](#).

Load Feeders and Motor Starters for Use in the Control Cabinet

SIRIUS 3RA2 Load Feeders

Accessories

For contactors	Version	Rated control supply voltage U_s ¹⁾		SD	Article No. ²⁾	Price per PU	PU (UNIT, SET, M)	PS*	PG
		AC operation	DC operation						
Type		V AC	V DC	d					

Surge suppressors without LED for contactors (also for spring-loaded terminals)

Size S00

For plugging onto the front side of the contactors (with or without auxiliary switches)



3RT2916-1B.00

3RT2.1	Varistors	24 ... 48	24 ... 70	▶	3RT2916-1BB00		1	1 unit	41B
		127 ... 240	150 ... 250						
3RT2.1	RC element	24 ... 48	24 ... 70	▶	3RT2916-1CB00		1	1 unit	41B
		127 ... 240	150 ... 250						
3RT2.1	Noise suppression diode	--	12 ... 250	▶	3RT2916-1DG00		1	1 unit	41B
3RT2.1	Diode assemblies (diode and Zener diode) for DC operation	--	12 ... 250	▶	3RT2916-1EH00		1	1 unit	41B

Size S0

For plugging onto the front side of the contactors (before installing the auxiliary switch)



3RT2926-1E.00

3RT2.2	Varistors ²⁾	24 ... 48	24 ... 70	▶	3RT2926-1BB00		1	1 unit	41B
		127 ... 240	150 ... 250						
3RT2.2	RC element	24 ... 48	24 ... 70	▶	3RT2926-1CB00		1	1 unit	41B
		127 ... 240	150 ... 250						
3RT2.2	Diode assemblies for DC operation	--	24	▶	3RT2926-1ER00		1	1 unit	41B
		--	30 ... 250						

Sizes S2 and S3

For plugging onto the front side of the contactors (before installing the auxiliary switch)



3RT2936-1B.00

3RT2.3,	Varistors ²⁾³⁾	24 ... 48	--	▶	3RT2936-1BB00		1	1 unit	41B
		3RT2.4	127 ... 240						
3RT2.3	RC element	24 ... 48	24 ... 70	▶	3RT2936-1CB00		1	1 unit	41B
		3RT2.4	127 ... 240						
3RT2.3,	Diode assemblies ³⁾ for DC operation	--	24	▶	3RT2936-1ER00		1	1 unit	41B
		3RT2.4	--						

Size S3

For plugging into the two recesses on the left of the connection block for auxiliary switches and coils A1 and A2. The connecting cables are wired to A1 and A2, see also page 3/11.



3RT2946-1C.00

3RT2.4	RC element	24 ... 48	24 ... 70	▶	3RT2946-1CB00		1	1 unit	41B
		127 ... 240	150 ... 250						

1) Can be used for AC operation for 50/60 Hz. Other voltages on request.

2) The varistor is already integrated on the AC/DC contactors.





3) Surge suppressors 3RT2936-1B/-1E can be used for 3RT2.4 contactors as from product version E03.

Load Feeders and Motor Starters for Use in the Control Cabinet

SIRIUS 3RA2 Load Feeders

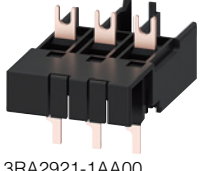
Accessories

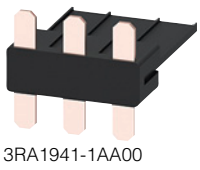
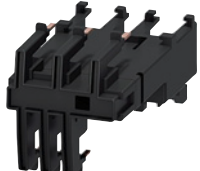
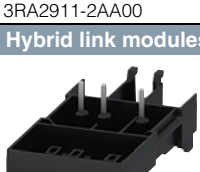
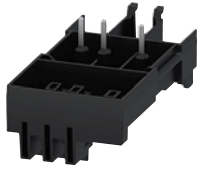
Accessories for the customer assembly of fuseless load feeders

	For motor starter protectors	For contactors	Actuating voltage of contactor	SD	Article No.	Price per PU	PU (UNIT, SET, M)	PS*	PG	
	Size	Size		d						
Link modules from motor starter protector to contactor¹⁾										
Connection between motor starter protector and contactor with screw terminals					Screw terminals 					
Single-unit packaging										
 3RA2921-1AA00	S00/S0	S00	AC/DC	▶	3RA1921-1DA00		1	1 unit	41B	
	S00/S0	S0	AC	▶	3RA2921-1AA00		1	1 unit	41B	
	S00/S0	S0	DC, AC/DC	▶	3RA2921-1BA00		1	1 unit	41B	
	S2	S2	AC, DC, AC/DC	▶	3RA2931-1AA00		1	1 unit	41B	
	S3	S3	AC, DC, AC/DC	▶	3RA1941-1AA00		1	1 unit	41B	
 3RA2931-1AA00	Multi-unit packaging									
	S00/S0	S00	AC/DC	▶	3RA1921-1D		1	10 units	41B	
	S00/S0	S0	AC	▶	3RA2921-1A		1	10 units	41B	
	S00/S0	S0	DC, AC/DC	▶	3RA2921-1B		1	10 units	41B	
	S2	S2	AC, DC, AC/DC	▶	3RA2931-1A		1	5 units	41B	
 3RA1941-1AA00	S3	S3	AC, DC, AC/DC	▶	3RA1941-1A		1	5 units	41B	
	Connection between motor starter protector and contactor with spring-loaded terminals					Spring-loaded terminals 				
	Single-unit packaging									
 3RA2911-2AA00	S00	S00	AC/DC	▶	3RA2911-2AA00		1	1 unit	41B	
	S0	S0	AC ²⁾ , DC, AC/DC	▶	3RA2921-2AA00		1	1 unit	41B	
Multi-unit packaging										
 3RA2911-2AA00	S00	S00	AC/DC	▶	3RA2911-2A		1	10 units	41B	
	S0	S0	AC ²⁾ , DC, AC/DC	▶	3RA2921-2A		1	10 units	41B	
Hybrid link modules from motor starter protector to contactor³⁾										
Connection between motor starter protector with screw terminals and contactor with spring-loaded terminals										
Single-unit packaging										
 3RA2911-2FA00	S00	S00	AC/DC	▶	3RA2911-2FA00		1	1 unit	41B	
	S0	S0	AC ²⁾ , DC, AC/DC	▶	3RA2921-2FA00		1	1 unit	41B	
Multi-unit packaging										
 3RA2921-2FA00	S00	S00	AC/DC	▶	3RA2911-2F		1	10 units	41B	
	S0	S0	AC ²⁾ , DC, AC/DC	▶	3RA2921-2F		1	10 units	41B	

¹⁾ The link modules from motor starter protector to contactor cannot be used for the 3RV1011, 3RV2.21-4PA1., 3RV2.21-4FA1., 3RV2.31-4K.1., 3RV2.31-4R.1., 3RV2.32-4K.1., 3RV2.32-4R.1., 3RV27 and 3RV28 motor starter protectors/circuit breakers.

²⁾ A spacer for height compensation on AC contactors, size S0, is optionally available, see page 8/53.

³⁾ The hybrid link modules for motor starter protector to contactor cannot be used for the 3RV1011, 3RV2.21-4PA1., 3RV2.21-4FA1., 3RV27 and 3RV28 motor starter protectors/circuit breakers. They are only suitable for constructing direct-on-line starters.

Note:

Link modules can be used in

- Size S00 up to max. 16 A
- Size S0 up to max. 32 A
- Size S2 up to max. 65 A





Hybrid link modules can be used in

- Size S00 up to max. 16 A
- Size S0 up to max. 32 A

Load Feeders and Motor Starters for Use in the Control Cabinet

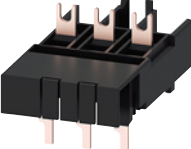
SIRIUS 3RA2 Load Feeders

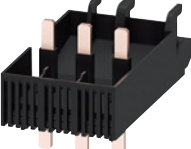
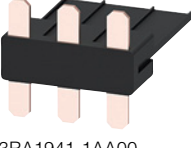
Accessories

For motor starter protectors	For 3RW30, 3RW40 soft starters; 3RF34 solid-state contactors	SD	Article No.	Price per PU	PU (UNIT, SET, M)	PS*	PG
Size	Size	d					
Link modules for motor starter protector to soft starter¹⁾ and motor starter protector to solid-state contactor¹⁾							
Connection between motor starter protector and soft starter/solid-state contactor with screw terminals			Screw terminals 				
Single-unit packaging							
 3RA2921-1BA00	S00/S0	S00/S0	2	3RA2921-1BA00	1	1 unit	41B
	S2 ²⁾	S2	▶	3RA2931-1AA00	1	1 unit	41B
	S3 ³⁾	S3	▶	3RA1941-1AA00	1	1 unit	41B
Multi-unit packaging							
	S00/S0	S00/S0	2	3RA2921-1B	1	10 units	41B
	S2 ²⁾	S2 ²⁾	▶	3RA2931-1A	1	5 units	41B
	S3 ³⁾	S3 ³⁾	▶	3RA1941-1A	1	5 units	41B
Connection between motor starter protector and soft starter with spring-loaded terminals			Spring-loaded terminals 				
Single-unit packaging							
 3RA2931-1AA00	S00	S00	2	3RA2911-2GA00	1	1 unit	41B
 3RA1941-1AA00	S0	S0	2	3RA2921-2GA00	1	1 unit	41B
 3RA2921-2GA00							

- ¹⁾ The link modules from motor starter protector to soft starter and motor starter protector to solid-state contactor cannot be used for the 3RV1011, 3RV2.21-4PA1., 3RV2.21-4FA1., 3RV2.31-4K.1., 3RV2.31-4R.1., 3RV2.32-4K.1., 3RV2.32-4R.1., 3RV27 and 3RV28 motor starter protectors/circuit breakers.
- ²⁾ To assemble the feeder between a motor starter protector and a soft starter in size S2, the 3RA2932-1CA00 standard mounting rail adapter must be used.
- ³⁾ It is only permitted to assemble the feeder between the motor starter protector and the soft starter in size S3 on a mounting plate.

Note:

Link modules can be used in

- Size S00 up to max. 16 A
- Size S0 up to max. 32 A
- Size S2 up to max. 65 A

Load Feeders and Motor Starters for Use in the Control Cabinet

SIRIUS 3RA2 Load Feeders

Accessories

PU (UNIT, SET, M) = 1
 PS* = 1 unit (unless otherwise specified)
 PG = 41B

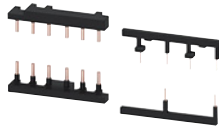

3RA2923-2AA1

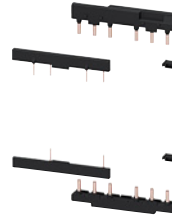

3RA2933-2AA1

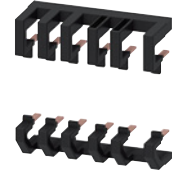

3RA2923-2AA2

For contactors	Size	Version	SD	Screw terminals		Spring-loaded terminals	
				Article No.	Price per PU	Article No.	Price per PU
Type			d				
Assembly kits for reversing contactor assemblies for making 3-pole contactor assemblies							
3RT201	S00-S00	The assembly kit contains: Mechanical interlock, two connecting clips for two contactors, wiring modules on the top and bottom • For main, auxiliary and control circuits	▶	3RA2913-2AA1	▶	3RA2913-2AA2	
3RT202	S0-S0	The assembly kit contains: Mechanical interlock, two connecting clips for two contactors, wiring modules on the top and bottom • For main, auxiliary and control circuits ¹⁾ • Only for main circuit ²⁾	▶	3RA2923-2AA1 --	▶	-- 3RA2923-2AA2	
3RT203	S2-S2	The assembly kit contains: Two connectors for two contactors, wiring modules on the top and bottom (3RA2934-2B mechanical interlock must be ordered separately, see page 3/113) • For main and auxiliary circuits • Only for main circuit ³⁾	▶	3RA2933-2AA1 --	5	-- 3RA2933-2AA2	
3RT204	S3-S3	The assembly kit contains: Two connectors for two contactors, wiring modules on the top and bottom (3RA2934-2B mechanical interlock must be ordered separately, see page 3/113) • For main and auxiliary circuits • Only for main circuit ³⁾	2	3RA2943-2AA1 --	2	-- 3RA2943-2AA2	

¹⁾ Use of the 3RA2923-2AA1 assembly kit in conjunction with the 3RT202-.....-3MA0 contactors is limited because the auxiliary switches in the basic unit are not allowed to be used on account of the permanently mounted auxiliary switch.

²⁾ Version in size S0 with spring-loaded terminals:
Only the wiring modules for the main circuit are included.
No connecting clips are included for the auxiliary and control circuit.

³⁾ Version in sizes S2 and S3 with spring-loaded terminals in the auxiliary and control circuits: Only the wiring modules for the main circuit are included.
A cable set is included for the auxiliary circuit.

Load Feeders and Motor Starters for Use in the Control Cabinet

SIRIUS 3RA2 Load Feeders

Accessories

For contactors	Version	SD	Article No.	Price per PU	PU (UNIT, SET, M)	PS*	PG
Size		d					

Safety main circuit connectors for two contactors



3RA2916-1A

switches two contactors in series

Screw terminals



S00		2	3RA2916-1A		1	1 unit	41B
S0		2	3RA2926-1A		1	1 unit	41B
S2		2	3RA2936-1A		1	1 unit	41B

For motor starter protectors	For contactors	Version	SD	Article No.	Price per PU	PU (UNIT, SET, M)	PS*	PG
			d					

Mounting rails for mounting contactors for the customer assembly of 3RA21 load feeders with busbar adapters for 60 mm systems

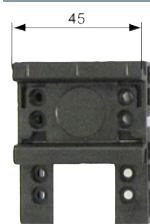

8US1998-7CB45

For the discrete configuration of direct-on-line starters a further mounting rail is needed for the contactor in addition to the mounting rail for the motor starter protector existing on the busbar adapter.

For pushing onto the device adapter, including fixing screws

--	S0	2	8US1998-7CB45		1	10 units	140
----	----	---	----------------------	--	---	----------	-----

Standard mounting rail adapters



3RA2922-1AA00

For mechanical fixing of motor starter protector and contactor; for snapping onto standard mounting rail or for screw fixing

S00, S0	S00, S0	Single-unit packaging	2	3RA2922-1AA00		1	1 unit	41B
S00, S0	S00, S0	Multi-unit packaging	2	3RA2922-1A		1	5 units	41B
S2	S2	Single-unit packaging	2	3RA2932-1AA00		1	1 unit	41B
S2	S2	Multi-unit packaging	2	3RA2932-1A		1	5 units	41B
S3	S3	Single-unit packaging	2	3RA2942-1AA00		1	1 unit	41B
S3	S3	Multi-unit packaging	2	3RA2942-1A		1	5 units	41B



3RA2932-1CA00

For mechanical fixing of motor starter protector and soft starter; for snapping onto standard mounting rail or for screw fixing

S2	S2	Single-unit packaging	2	3RA2932-1CA00		1	1 unit	41B
----	----	------------------------------	---	----------------------	--	---	--------	-----

Side modules for standard mounting rail adapters







3RA2902-1B

S00 ... S3	S00 ... S3	For standard mounting rail adapters 10 mm wide, 96 mm long, For widening standard mounting rail adapters when using lateral auxiliary switches, 2 units required	2	3RA2902-1B		1	10 units	41B
------------	------------	---	---	-------------------	--	---	----------	-----

Load Feeders and Motor Starters for Use in the Control Cabinet

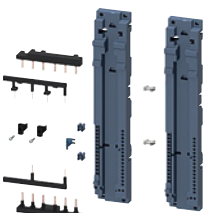
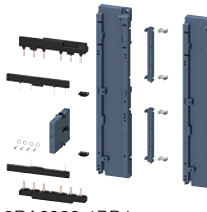
SIRIUS 3RA2 Load Feeders

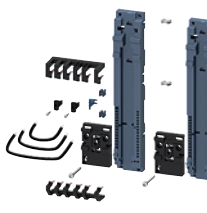
Accessories

	For motor starter protectors	For contactors	Version	SD	Article No.	Price per PU	PU (UNIT, SET, M)	PS*	PG
RH assembly kits for reversing duty and standard rail mounting									
RH assembly kits for screw terminals					Screw terminals 				
	S0	S0	Comprising: <ul style="list-style-type: none"> • Wiring kit for main and auxiliary circuit • Two standard mounting rail adapters • Two connecting wedges • Mechanical interlocks • Two connecting clips for two contactors • Fixing accessories Link modules must be ordered separately.	2	3RA2923-1BB1		1	1 unit	41B
3RA2923-1BB1									
	S2	S2	Comprising: <ul style="list-style-type: none"> • Wiring kit for main and auxiliary circuit • Two standard mounting rail adapters • Two side modules • Four connecting wedges • Mechanical interlocks • Two connectors for two contactors • Fixing accessories Link modules must be ordered separately.	2	3RA2933-1BB1		1	1 unit	41B
3RA2933-1BB1									
	S3	S3	Comprising: <ul style="list-style-type: none"> • Wiring kit for main and auxiliary circuit • Two standard mounting rail adapters • Three side modules • Six connecting wedges • Mechanical interlocks • Two connectors for two contactors • Fixing accessories Link modules must be ordered separately.	2	3RA2943-1BB1		1	1 unit	41B
3RA2943-1BB1									
RH assembly kits for spring-loaded terminals					Spring-loaded terminals 				
	S0	S0	Comprising: <ul style="list-style-type: none"> • Wiring kit for main and auxiliary circuit • Two standard mounting rail adapters • Two connecting wedges • Mechanical interlocks • Two connecting clips for two contactors • Two spacers • Fixing accessories Link modules must be ordered separately.	2	3RA2923-1BB2		1	1 unit	41B
3RA2923-1BB2									
Push-in lugs for screw fixing									
	S00, S0	--	For screwing the motor starter protector (of the load feeder) onto mounting plates; 2 units are required for each motor starter protector	2	3RV2928-0B		100	10 units	41E
3RV2928-0B									

For graphic overviews for RH assembly kits, see page 8/12 onwards.

Load Feeders and Motor Starters for Use in the Control Cabinet

SIRIUS 3RA2 Load Feeders

Accessories

Busbar adapters



8US1251-5DS10



8US1251-5DT11



8US1250-5AS10



8US1250-5AT10

For load feeders	Rated current	Connecting cable	Adapter length	Adapter width	Rated voltage	SD	Article No.	Price per PU	PU (UNIT, SET, M)	PS*	PG
Size	A	AWG	mm	mm	V	d					
Busbar adapters for 60 mm systems											
For flat copper profiles according to DIN 46433 Width: 12 mm and 30 mm Thickness: 5 mm and 10 mm and for T and double-T special profiles											
• For load feeders with screw terminals											
							Screw terminals				
S00/S0	25	12	200	45	690	2	8US1251-5DS10		1	1 unit	140
S00 (motor starter protector)/ S0 (contactor)	25	12	260	45	690	2	8US1251-5DT10		1	1 unit	140
S0	32	10	200	45	690	3	8US1251-5NS10		1	1 unit	140
S0	32	10	260	45	690	2	8US1251-5NT10		1	1 unit	140
S2	80	4	260	55	690	5	8US1261-6MT10		1	1 unit	140
S2 ¹⁾	80	4	260	118	690	5	8US1211-6MT10		1	1 unit	140
• For load feeders with spring-loaded terminals											
							Spring-loaded terminals				
S00	25	12	200	45	690	2	8US1251-5DS11		1	1 unit	140
S00/S0	25	12	260	45	690	2	8US1251-5DT11		1	1 unit	140
S0	32	10	200	45	690	5	8US1251-5NS11		1	1 unit	140
S0	32	10	260	45	690	2	8US1251-5NT11		1	1 unit	140
Accessories²⁾											
Device holders											
For lateral mounting onto busbar adapters											
	--	--	200	45	--	2	8US1250-5AS10		1	1 unit	140
	--	--	260	45	--	2	8US1250-5AT10		1	1 unit	140
Side modules											
For widening busbar adapters											
	--	--	200	9	--	2	8US1998-2BJ10		1	10 units	140
Vibration and shock kits											
For high vibration and shock loads											
S2	--	--	--	--	--	5	8US1998-1DA10		1	1 unit	140





¹⁾ For the assembly of feeders for reversing starters comprising a motor starter protector and two contactors.

²⁾ For additional mounting rails for busbar adapters, see page 8/50.

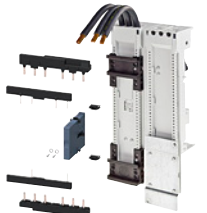

Load Feeders and Motor Starters for Use in the Control Cabinet

SIRIUS 3RA2 Load Feeders

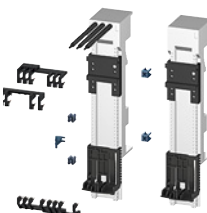
Accessories

For motor starter protectors Size	For contactors Size	Version	SD	Article No.	Price per PU	PU (UNIT, SET, M)	PS*	PG
RS assembly kits for reversing duty and 60 mm busbar systems								
RS assembly kits for screw terminals								
								
 3RA2913-1DB1	S00, S0	S00	Comprising:	2	3RA2913-1DB1 3RA2923-1DB1 3RA2923-1EB1	1	1 unit	41B
	S0	S0	• Wiring kit for main and auxiliary circuit	2		1	1 unit	41B
	S00	S0	• Busbar adapters • Device holders • Two connecting wedges • Mechanical interlocks • Two connecting clips for two contactors • Fixing accessories	2		1	1 unit	41B
Link modules must be ordered separately.								
 3RA2933-1DB1	S2	S2	Comprising:	2	3RA2933-1DB1	1	1 unit	41B
			• Wiring kit for main and auxiliary circuit • Busbar adapters • Mechanical interlocks • Two connectors for two contactors • Fixing accessories					
Link modules must be ordered separately.								
RS assembly kits for spring-loaded terminals								
								
 3RA2913-1DB2	S00	S00	Comprising:	2	3RA2913-1DB2 3RA2923-1DB2	1	1 unit	41B
	S0	S0	• Wiring kit for main and auxiliary circuit	2		1	1 unit	41B
			• Busbar adapters • Device holders • Two connecting wedges • Mechanical interlocks • Two connectors for two contactors • Two spacers (for size S0 only) • Fixing accessories					
Link modules must be ordered separately.								





For graphic overviews for RS assembly kits, see [page 8/15 onwards](#).

For motor starter protectors Size	For contactors Size	Version	SD	Article No.	Price per PU	PU (UNIT, SET, M)	PS*	PG	
Connecting wedges									
 8US1998-1AA00			For mechanical linking of busbar adapters and device holders or of standard mounting rail adapters (2 units per combination required)	2	8US1998-1AA00	100	100 units	140	
Spacers									
 3RA2911-1CA00			For height compensation on AC contactors size S0 with spring-loaded terminals		Spring-loaded terminals 				
	S0	S0	Single-unit packaging	2		3RA2911-1CA00	1	1 unit	41B
	S0	S0	Multi-unit packaging	2		3RA2911-1C	1	5 units	41B

Load Feeders and Motor Starters for Use in the Control Cabinet

SIRIUS 3RA2 Load Feeders

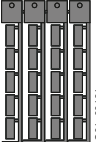
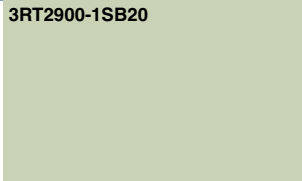
Accessories

Version	SD	Article No.	Price per PU	PU (UNIT, SET, M)	PS*	PG
Tools for opening spring-loaded terminals						
 3RA2908-1A	2	Screwdrivers For all SIRIUS devices with spring-loaded terminals Length approx. 200 mm, 3.0 mm x 0.5 mm, titanium gray/black, partially insulated	 Spring-loaded terminals 3RA2908-1A	1	1 unit	41B
Blank labels						
 3RT2900-1SB20	20	Unit labeling plates¹⁾ For SIRIUS devices 20 mm x 7 mm, titanium gray	 3RT2900-1SB20	100	340 units	41B
Configuration Manual "Load Feeders – Configuring the SIRIUS Modular System"						
		Configuration manual for new combinations of load feeders Information and assignment tables for combinations for self-assembly; Configuration Manual, see https://support.industry.siemens.com/cs/ww/en/view/39714188 .				

¹⁾ PC labeling system for individual inscription of unit labeling plates available from: murrplastik Systemtechnik GmbH (see page 16/15).

Load Feeders and Motor Starters for Use in the Control Cabinet

SIRIUS 3RA2 Load Feeders

3RV29 infeed system for load feeders

Overview

Types of infeed for 3RA2 fuseless load feeders

On the whole four different power infeed possibilities are available:

- Parallel wiring
- Use of three-phase busbars (combination with SIRIUS motor starter protectors and contactors possible)
- 8US busbar adapters
- SIRIUS 3RV29 infeed systems

Insulated three-phase busbar system

Three-phase busbar systems provide an easy, time-saving and clearly arranged means of feeding 3RA2 load feeders with screw terminals. Different versions are available for sizes S00 and S0 and can also be used for the various different types of motor starter protectors.

The busbars are suitable for between two and five feeders. However, any kind of extension is possible by clamping the tags of an additional busbar (rotated by 180°) underneath the terminals of the respective last motor starter protector.

A combination of feeders of different sizes is possible with sizes S00 and S0. Connecting pieces are available for this purpose. The motor starter protectors are supplied by appropriate infeed terminals.

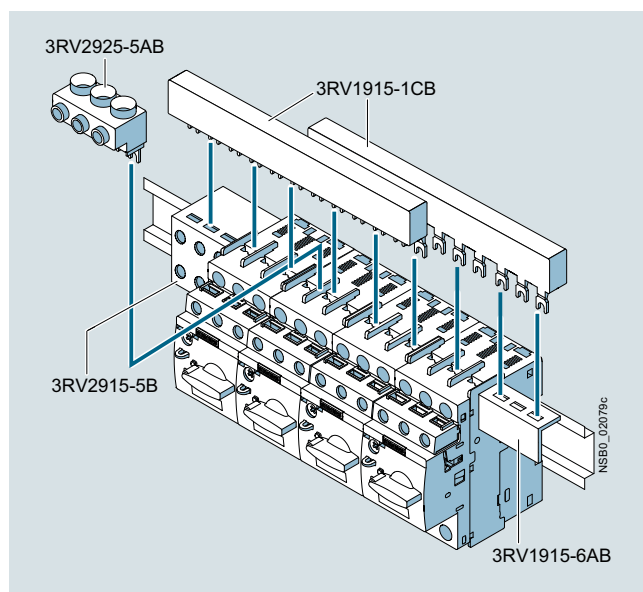

SIRIUS three-phase busbar system size S00/S0

The three-phase busbar systems are finger-safe. They are designed for any short-circuit stress which can occur at the output side of connected motor starter protectors.

The three-phase busbar systems can also be used to construct "Starters (Type E)" of size S0 or S2 according to UL/CSA. However, special infeed terminals must be used for this purpose; see page 7/48.

8US busbar adapters for 60 mm systems

The load feeders are mounted directly with the aid of busbar adapters on busbar systems with 60 mm center-to-center clearance in order to save space and to reduce infeed times and costs.

The busbar adapters for busbar systems with 60 mm center-to-center clearance are suitable for copper busbars with a width of 12 to 30 mm. The busbars can be 4 to 5 mm or 10 mm thick.

The feeders are snapped onto the adapter and connected on the line side. This prepared unit is then plugged directly onto the busbar system, and is thus connected both mechanically and electrically at the same time.

For "Selection and ordering data", see page 8/52.

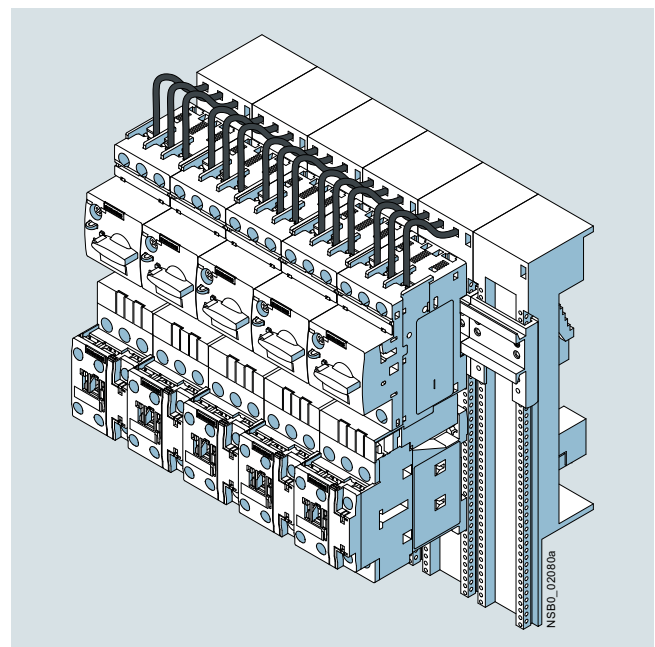

SIRIUS load feeders with busbar adapters snapped onto busbars

SIRIUS 3RV29 infeed system

The 3RV29 infeed system is a convenient means of energy supply and distribution for a group of several motor starter protectors or complete load feeders with a screw or spring-loaded terminal up to size S0.

The system is based on a basic module complete with a lateral incoming unit (three-phase busbar with infeed) which has two slots.

Expansion modules are available for extending the system (three-phase busbars for system expansion).

For the 3RV29 infeed system, see page 7/62.

Load Feeders and Motor Starters for Use in the Control Cabinet

SIRIUS 3RA6 Compact Starters

General data

Overview

3RA6 fuseless compact starters and infeed system for 3RA6



3RA62 reversing starter

Integrated functionality

The SIRIUS 3RA6 compact starters are a generation of special load feeders with the integrated functionality of a motor starter protector, contactor and electronic overload relay. In addition, various functions of optional mountable accessories (e.g. auxiliary switches, surge suppressors) are already integrated in the SIRIUS compact starter.

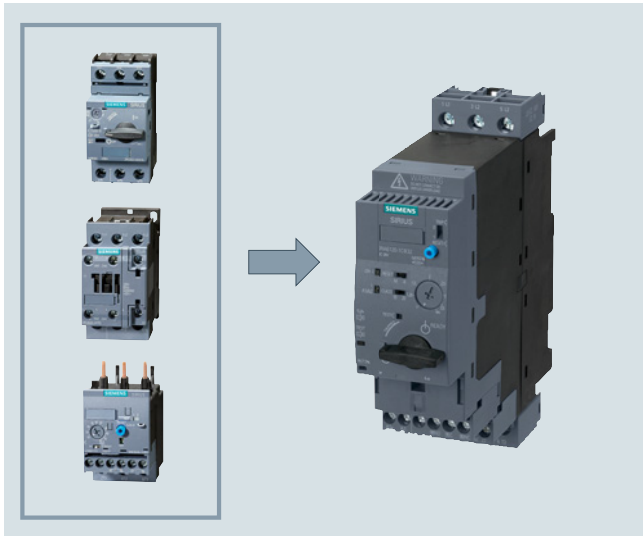

3RA6 compact starters with the integrated functionality of a motor starter protector, contactor and electronic overload relay.

Applications

SIRIUS compact starters can be used wherever standard three-phase motors or resistive loads up to 32 A (approx. 15 kW/400 V) are directly started or switched.

The compact starters are not suitable for the protection of DC loads.

Approvals according to IEC, UL, CSA and CCC standards have been issued for the compact starters.

More information

Industry Mall, see www.siemens.com/product?3RA68

Online configurator, see www.siemens.com/sirius/configurators

Very high operational reliability

The high short-circuit breaking capacity and defined shut-down when the end of service life is reached mean that the SIRIUS compact starter achieves a very high level of operational reliability that would otherwise have only been possible with considerable additional outlay. This sets it apart from devices with similar functionality.

Safe disconnection

The auxiliary switches (NC contacts) of the 3RA6 compact starters are designed as mirror contacts. This enables their use for safe disconnection – e.g. EMERGENCY STOP up to SIL 1 (IEC 62061) or PL c (ISO 13849-1) or, if used in conjunction with an additional infeed contactor, up to SIL 3 (IEC 62061) or PL e (ISO 13849-1).

Communications integration through AS-Interface

To enable communications integration through AS-Interface there is an AS-i add-on module available in several versions for mounting instead of the control circuit terminals on the SIRIUS compact starter.

The design of the AS-i add-on module permits a group of up to 62 feeders with a total of four cables to be connected to the control system. This reduces wiring work considerably compared to the parallel wiring method.

Communications integration using IO-Link

Up to four compact starters in IO-Link version (reversing and direct-on-line starters) can be connected together and conveniently linked to the IO-Link master through a standardized IO-Link connection.

The IO-Link connection enables a high density of information in the local range.

For details of the communication connection using IO-Link, see [page 2/93 onwards](#).

The diagnostics data of the process collected by the 3RA6 compact starter, e.g. short circuit, end of service life, limit position, etc., are not only indicated on the compact starter itself but also transmitted to the higher-level control system through IO-Link.

Thanks to the optionally available operator panel, which can be installed in the control cabinet door, it is easy to control the 3RA6 compact starters with IO-Link from the control cabinet door.

Permanent wiring/easy replacement

Using the SIRIUS infeed system for 3RA6 (see [page 8/78](#)), it is possible to carry out the wiring in advance without a compact starter having to be connected.

A compact starter is very easily replaced simply by pulling it out of the device without disconnecting the wiring.

Even with screw fixing or mounting on a standard mounting rail there is no need to disconnect any wiring (on account of the removable main and control circuit terminals) in order to replace a compact starter.

Load Feeders and Motor Starters for Use in the Control Cabinet

SIRIUS 3RA6 Compact Starters

General data

Consistent solution from the infeed to the motor feeder

The SIRIUS infeed system for 3RA6 with integrated PE bar is offered as a user-friendly possibility of feeding in summation currents up to 100 A with a maximum conductor cross-section of 70 mm² and connecting the motor cable directly without additional intermediate terminals.

Screw and spring-loaded terminals

The SIRIUS compact starters and the infeed system for 3RA6 are available with screw and spring-loaded terminals.



Screw terminals



Spring-loaded terminals

The terminals are indicated in the corresponding tables by the symbols shown on orange backgrounds.

System configurator for engineering

A free system configurator is available to reduce further the amount of engineering work for selecting the required compact starters and matching infeed.

Use of load feeders in conjunction with IE3/IE4 motors

Note:

For the use of SIRIUS 3RA6 compact starters in conjunction with highly energy-efficient IE3/IE4 motors, please observe the information on dimensioning and configuring, [see Application Manual](#).

For more information, [see page 1/7](#).

Types of infeed for the 3RA6 fuseless compact starters

On the whole four different infeed possibilities are available:

- Parallel wiring
- Use of three-phase busbars (combination with SIRIUS motor starter protectors and SIRIUS contactors possible)
- 8US busbar adapters
- SIRIUS infeed system for 3RA6 ([see page 8/78](#))

To comply with the clearances and creepage distances demanded according to UL 508 there are the following infeed possibilities:

Type of infeed	Infeed terminal (according to UL 508, Type E)	Type
Parallel wiring	Terminal block for "Self-Protected Combination Motor Controller (Type E)"	3RV2928-1H
Three-phase busbars	Three-phase infeed terminal for constructing "Starters (Type E)", UL 508	3RV2925-5EB
Infeed system for 3RA6	Infeed on left, 50/70 mm ² screw terminal with 3 sockets, outgoing terminal with screw/spring-loaded terminals, including PE bar	3RA6813-8AB (screw terminals), 3RA6813-8AC (spring-loaded terminals)

SIRIUS 3RA6 compact starters

SIRIUS 3RA6 compact starters are universal motor feeders according to IEC 60947-6-2. As control and protective switching devices (CPS) they can connect, convey and disconnect the thermal, dynamic and electrical loads from short-circuit currents up to $I_G = 53$ kA, i.e. they are practically weld-free. They combine the functions of a motor starter protector, a contactor and an electronic overload relay in one enclosure. 45-mm-wide direct-on-line starters and 90-mm-wide reversing starters are available as variants.

The reversing starter version comes with not only an internal electrical interlock but also with a mechanical interlock to prevent simultaneous actuation of both directions of rotation.

The compact starters have isolating features in accordance with IEC 60947-2 and can be used as disconnecter units (main control switch according to EN 60204 or VDE 0113). Isolation is effected by moving the handle into the "OFF" position; disconnection by means of the control contacts is not enough.

3RA6 fuseless compact starters are available in five current setting ranges. The 3RA61 and 3RA62 have two control voltage ranges (AC/DC), and the 3RA64 and 3RA65 have one control voltage range (DC):

Current setting range	At 400 V AC for three-phase motors Standard output P	Rated control supply voltage for	
		3RA61, 3RA62 compact starters	3RA64, 3RA65 compact starters for IO-Link
A	kW	V AC/DC	V DC
0.1 ... 0.4	0.09	24	24
0.32 ... 1.25	0.37	110 ... 240	
1 ... 4	1.5		
3 ... 12	5.5		
8 ... 32	15		

Notes:

The 3RA2 load feeders can be used for fuseless load feeders > 32 A up to 65 A. Load feeders in size S3 up to 100 A are available for self-assembly ([see also page 8/4](#)).

The SENTRON 3VL circuit breakers and the SIRIUS 3RT contactors can be used for fuseless load feeders > 100 A.

Operating conditions

The SIRIUS 3RA6 compact starters are suitable for use in any climate. They are intended for use in enclosed rooms in which no severe operating conditions (such as dust, caustic vapors, hazardous gases) prevail. Suitable covers must be provided for installation in dusty and damp locations.

The SIRIUS compact starters are generally designed to degree of protection IP20. The permissible ambient temperature during operation is -20 to +60 °C. The rated short-circuit current I_{CS} according to IEC 60947-6-2 is 53 kA at 400 V.

Note:

The maximum permissible short-circuit currents of the device versions for the various forms of power supply and voltages are available on request from Technical Support: <https://support.industry.siemens.com/My/ww/en/requests>.

Load Feeders and Motor Starters for Use in the Control Cabinet

SIRIUS 3RA6 Compact Starters

General data

Overload tripping times

The tripping time in the event of overload can be set on the device to normal starting conditions (CLASS 10) and to heavy starting conditions (CLASS 20). As the breaker mechanism still remains closed after an overload, resetting is possible by either local Manual RESET or Auto RESET after three minutes cooling time.

With Auto RESET, there is no need to open the control cabinet.

Diagnostics options

The compact starter provides the following diagnostics options:

- With LEDs
 - Connection to the control voltage
 - Position of the main contacts
- With mechanical display
 - Tripping due to overload
 - Tripping due to short circuit
 - Tripping due to malfunction (end of service life reached because of worn switching contacts or a worn switching mechanism or faults in the control electronics)

These states can also be evaluated in the higher-level control system:

- With parallel wiring using the integrated auxiliary and signaling switches of the compact starter
- With AS-Interface or IO-Link in even greater detail using the respective communication interface

Four complement versions for 3RA61 and 3RA62 compact starters

- For standard mounting rail or screw fixing: basic version including one pair of main circuit terminals and one pair of control circuit terminals
- For standard mounting rail or screw fixing when using the AS-i add-on module: without control circuit terminals because the AS-i add-on module is plugged on instead
- For use with the infeed system for 3RA6: without main circuit terminals because they are supplied with the infeed system and the expansion modules
- For use with the infeed system for 3RA6 and the AS-i add-on module: without terminal complement (also for reordering when replacing the compact starter)

The control circuit terminals are always required by the compact starters for IO-Link; the main circuit terminals depend on the use of the infeed system.

More components of the 3RA6

Apart from the control supply voltage, "Overload" (1 CO) and "Short circuit/Function fault" (1 NO) signaling contacts are already integrated into the 3RA61/3RA62 – and lockable via two 6-pole removable control circuit terminals. The 3RA61 has two auxiliary contacts (1 NO + 1 NC) for displaying the position of the main contacts. Unlike the 3RA61 direct-on-line starter, the 3RA62 reversing starter has one auxiliary contact (1 NO) per direction of rotation per main contact.

Available for the 3RA61 and 3RA64 direct-on-line starters is a slot for an optional auxiliary switch (optionally 2 NO, 2 NC or 1 NO + 1 NC) and for the 3RA62 and 3RA65 reversing starters there are two slots (for auxiliary switches, see "Accessories" on page 8/71).

Positively-driven operation of the auxiliary contacts

Positively-driven operation between individual auxiliary circuits exists for the compact starter in the version as a direct-on-line starter for parallel wiring (3RA61) between the auxiliary circuits of the NC contacts (NC 21-22) and the NO contacts (NO 13-14) in the basic unit. In addition, the optional auxiliary switch offers positively driven contacts in the 3RA6913-1A version, each with one normally closed contact and one normally open contact.

Configurator

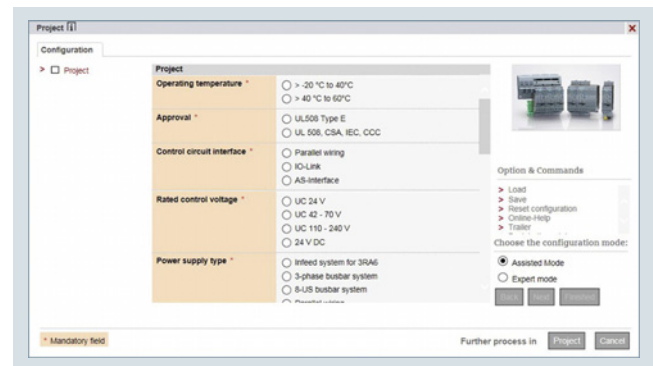

Configurator

Advantages:

- Simple usage – from individual compact starters or also with corresponding infeed system and AS-i connection
- In the final configuration, you will be presented with additional technical information such as CAD data and product data sheets as well as characteristic curves, operating instructions, manuals, etc.

See www.siemens.com/sirius/configurators

Load Feeders and Motor Starters for Use in the Control Cabinet

SIRIUS 3RA6 Compact Starters

General data

Article No. scheme

Product versions		Article number												
Compact starters		3	R	A	6	□	□	□	□	□	□			
Product function	Direct-on-line starter	1	2	0							For motor standard output 0.09 ... 15 kW ¹⁾			
	Reversing starter	2	5	0							For motor standard output 0.09 ... 15 kW ¹⁾			
	Direct-on-line starter for IO-Link	4	0	0							For motor standard output 0.09 ... 15 kW ¹⁾			
	Reversing starter for IO-Link	5	0	0							For motor standard output 0.09 ... 15 kW ¹⁾			
	Infeed system	8												
	Accessories	9												
	• Auxiliary switches	1	□											
	• Terminals	2	□											
	• IO-Link accessories	3	□											
	• Fixing elements	4	□											
• Control kit	5	□												
Connection methods	No terminals					0								
	Screw terminals					1								
	Spring-loaded terminals					2								
Setting range	0.1 ... 0.4 A							A						
	0.32 ... 1.25 A							B						
	1 ... 4 A							C						
	3 ... 12 A							D						
	8 ... 32 A							E						
Rated control supply voltage	24 V DC							B	4		For direct-on-line/reversing starters for IO-Link			
	24 V AC/DC							B	3		For direct-on-line/reversing starters			
	110 ... 240 V AC/DC							P	3		For direct-on-line/reversing starters			
Terminal complement variant	None							0			Without main and control circuit terminals			
	1/1							2			With 1 pair of main circuit and 1 pair of control circuit terminals			
	0/1							3			Without main circuit terminals, with 1 pair of control circuit terminals			
	1/0							4			With 1 pair of main circuit terminals, without control circuit terminals			
Special versions														
Example		3	R	A	6	1	2	0	-	0	A	B	3	0

¹⁾ Standard three-phase motor, basis 4-pole at 400 V AC; the actual startup characteristics of the motor as well as its rated data are important factors here.

Note:

The Article No. scheme shows an overview of product versions for better understanding of the logic behind the article numbers.

For your orders, please use the article numbers quoted in the selection and ordering data.

Load Feeders and Motor Starters for Use in the Control Cabinet

SIRIUS 3RA6 Compact Starters

General data

Benefits

Product advantages

The SIRIUS 3RA6 compact starters offer a number of benefits:

- Compact design saves space in the control cabinet
- Little planning and assembly work and far less wiring thanks to a single complete unit with one article number
- Low variance and therefore low stock levels, with two wide voltage ranges and five wide setting ranges for the rated current
- High plant availability through integrated functionalities such as prevention of main contact welding and disconnection at end of service life
- Enhanced productivity through automatic device reset in case of overload and differentiated detection of overload and short circuit
- Easy checking of the wiring and testing of the motor direction prior to startup thanks to optional control kits

- Speedy replacement of devices thanks to removable terminals with spring-loaded and screw terminals in the main and control circuit
- Efficient power distribution through the related SIRIUS infeed system for 3RA6
- Direct connection of the motor feeder cable to the SIRIUS infeed system for 3RA6 thanks to integrated PE bar
- Connecting and looping through of incoming feeders up to a cross-section of 70 mm²
- When using the infeed system for 3RA6, possibility of directly connecting the motor cable without intermediate terminals
- Integration in Totally Integrated Automation thanks to the optional connection to AS-Interface or IO-Link

The SIRIUS 3RA6 compact starters create the basis for high-availability and future-proof machine concepts.

Load Feeders and Motor Starters for Use in the Control Cabinet

SIRIUS 3RA6 Compact Starters

General data

Technical specifications

More information

Industry Mall, see www.siemens.com/product?3RA6
 System Manual, see <http://support.industry.siemens.com/cs/ww/en/view/27865747>
 FAQs, see <https://support.industry.siemens.com/cs/ww/en/ps/16301/faq>

Notes on security:
 In order to protect plants, systems, machines and networks against cyber threats, it is necessary to implement – and continuously maintain – a holistic, state-of-the-art industrial security concept. Siemens products and solutions represent only one component of such a concept.
 For more information about the subject of Industrial Security, see www.siemens.com/industrialsecurity.

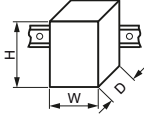
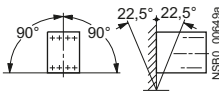
Type		3RA61	3RA62	3RA64	3RA65	
Mechanics and environment						
Mounting dimensions (W x H x D)		mm	45 x 170 x 165	90 x 170 x 165	45 x 170 x 165	90 x 170 x 165
<ul style="list-style-type: none"> Screw terminals Spring-loaded terminals 		mm	45 x 191 x 165	90 x 191 x 165	45 x 191 x 165	90 x 191 x 165
Depth from standard mounting rail		mm	160			
Permissible ambient temperature		°C	-20 ... +70, restriction as from 60 depending on design			
<ul style="list-style-type: none"> For operation (permissible operational current, see the following section "Electrical specifications") During storage During transport 		°C	-55 ... +80			
		°C	-55 ... +80			
Permissible mounting position						
Shock resistance (sine-wave pulse)			a = 60 m/s ² = 6 g with 10 ms; for every 3 shocks in all axes			
Vibratory load			f = 4 ... 5.8 Hz; d = 15 mm; f = 5.8 ... 500 Hz; a = 20 m/s ² ; 10 cycles			
Degree of protection	Acc. to IEC 60947-1		IP20			
Installation altitude		m	Up to 2 000 above sea level without restriction			
Relative air humidity		%	10 ... 90			
Pollution degree			3			
Electrical specifications						
Device standard			IEC 60947-6-2			
Maximum rated operational voltage U_e		V	690			
		V	400 at 3RA6250-E... and 3RA6500-E... (Reversing starter 32 A designs)			
Rated frequency		Hz	50/60			
Rated insulation voltage U_i (pollution degree 3)		V	690			
Rated impulse withstand voltage U_{iimp}		kV	6			
Rated operational current I_e¹⁾ and setting range for overload release	0.1 ... 0.4 A 0.32 ... 1.25 A 1 ... 4 A 3 ... 12 A 8 ... 32 A	A	0.4 1.25 4 12 32			
Permissible operational current of the compact starter²⁾ When several compact starters are mounted side-by-side in the 3RA6 infeed system (for more details on the various design variants, see System Manual)						
<ul style="list-style-type: none"> For a control cabinet inside temperature of +40 °C For a control cabinet inside temperature of +60 °C For a control cabinet inside temperature of +70 °C 		%	100 80 60			
Trip class (CLASS)	Acc. to IEC 60947-4-1, EN 60947-4-1 (VDE 0660 Part 102)		10/20			
Overload function Ratio of lower to upper current mark			1:4			
Rated service short-circuit breaking capacity I_{CS} at 50/60 Hz, 400 V AC		kA	53			
Rated service short-circuit breaking capacity I_{CSIT} at 50/60 Hz 400/690 V AC in IT systems		kA	1.5			

¹⁾ For the use of 3RA6 compact starters in conjunction with highly energy-efficient IE3/IE4 motors, please observe the information on dimensioning and configuring, see Application Manual.

²⁾ Details about installation conditions and the use of the compact starters, and particularly about the derating of the rated current, can be found in the System Manual.

Load Feeders and Motor Starters for Use in the Control Cabinet

SIRIUS 3RA6 Compact Starters

General data

Type			3RA61	3RA62	3RA64	3RA65
Electrical specifications (continued)						
Power loss P_V max of all main current paths Dependent on rated current I_e (upper setting range)	0.4 A	mW	10			
	1.25 A	mW	100			
	4 A	W	1			
	12 A	W	1.8			
	32 A	W	5.4			
Max. switching frequency	AC-41	1/h	750			
	AC-43	1/h	250			
	AC-44	1/h	15			
No-load switching frequency		1/h	3 600		3 600, depending on the IO-Link communication time	
Touch protection	Acc. to DIN VDE 0106, Part 100		Finger-safe			
Isolating features of the compact starter	Acc. to IEC 60947-3		✓ Isolation is assured only by moving the actuator into the "OFF" position.			
Main and EMERGENCY STOP switch characteristics of the compact starter and accessories	Acc. to IEC 60204		✓			
Protective separation	Acc. to IEC 60947-2					
Control circuit to auxiliary circuit						
• Horizontal standard mounting rail		V	Up to 400			
• Other mounting position		V	Up to 250			
Auxiliary circuit to auxiliary circuit						
• Horizontal standard mounting rail		V	Up to 400			
• Other mounting position		V	Up to 250			
Main circuit to auxiliary circuit						
• Any mounting position		V	Up to 400			
EMC interference immunity	Acc. to IEC 60947-1		Corresponds to degree of severity 3			
Conducted interference	BURST acc. to IEC 61000-4-4					
• In the main circuit		kV	4		4	
• In the auxiliary circuit		kV	3		2	
Conducted interference	SURGE acc. to IEC 61000-4-5					
• In the main circuit						
- Conductor - Ground		kV	4		2	
- Conductor - Conductor		kV	2		1	
• In the auxiliary circuit						
- Conductor - Ground		kV	2		0.5 ¹⁾	
- Conductor - Conductor		kV	1		0.5 ¹⁾	
Auxiliary switches						
• Integrated						
- Position of the main contacts			1 NO + 1 NC	2 NO	1 NO + 1 NC	2 NO
- Overload/short circuit and malfunction signal			1 CO/1 NO			
• Expandable						
- Position of the main contacts			2 NO, 2 NC, 1 NO + 1 NC			
Surge suppressors			Integrated (varistor)			
Electromagnetic operating mechanisms						
Control voltage		V	24 AC/DC		24 DC	
		V	110 ... 240 AC/DC		--	
Frequency	At AC	Hz	50/60 (± 5%)			
Operating range			0.7 ... 1.25 U_s		0.85 ... 1.2 U_s	
No-load switching frequency		1/h	3 600			
Line protection	At 10 kA	mm ²	2.5			
	At 50 kA	mm ²	4			
Shock resistance						
• Breaker mechanism OFF		g	25			
• Breaker mechanism ON		g	15			
Normal switching duty						
Making capacity			12 x I_n			
Breaking capacity			10 x I_n			
Switching capacity dependent on rated current	Up to 12 A	kW	5.5			
	Up to 32 A	kW	15			
Endurance in operating cycles						
• Electrical endurance	At $I_e = 0.9 \times I_n$ and 400 V		3 ... 10 000 000	2 x 3 ... 10 000 000	3 000 000	2 x 1 500 000

✓ Function available

¹⁾ To maintain maximum interference immunity in a harsh electromagnetic environment, additional overvoltage protection should be provided in the control circuit. The 5SD7432-4 plug-in surge arrester with remote signaling, for instance, is suitable, see [Catalog LV 10](#).

Load Feeders and Motor Starters for Use in the Control Cabinet

SIRIUS 3RA6 Compact Starters

General data

Type		3RA6120-□B3., 3RA6250-□B3. □ = A, B, C or D Rated operational current ≤ 12 A				3RA6120-EB3., 3RA6250-EB3. Rated operational current 32 A			
Rated control supply voltage	V	24 AC		24 DC		24 AC		24 DC	
Inrush peak current	A	0.59		0.47		0.59		0.47	
Hold current	A	0.13		0.12		0.17		0.14	
Closed	W	2.8		2.9		3.5		3.1	
Operating times, typical									
• On	ms	< 160		< 140		< 160		< 140	
• Off	ms	< 35		< 35		< 30		< 30	
Type		3RA6 20-□P3., 3RA6250-□P3. □ = A, B, C or D Rated operational current ≤ 12 A				3RA6120-EP3., 3RA6250-EP3. Rated operational current 32 A			
Rated control supply voltage	V	110 AC	240 AC	110 DC	240 DC	110 AC	240 AC	110 DC	240 DC
Inrush peak current	A	0.24	0.40	0.17	0.29	0.24	0.40	0.17	0.29
Hold current	A	0.06	0.08	0.03	0.02	0.06	0.07	0.04	0.03
Closed	W	3.8	6	3.1	5.1	3.7	5.2	3.4	5.8
Operating times, typical									
• On	ms	< 160	< 140	< 150	< 140	< 160	< 140	< 150	< 140
• Off	ms	< 50	< 80	< 50	< 70	< 40	< 60	< 40	< 60
Type		3RA6400-□B4., 3RA6500-□B4. □ = A, B, C or D Rated operational current ≤ 12 A				3RA6400-EB4., 3RA6500-EB4. Rated operational current 32 A			
Rated control supply voltage	V	24 DC				24 DC			
Inrush peak current	A	0.39				0.53			
Hold current	A	0.13				0.15			
Closed	W	2.9				3.4			
Operating times, typical ¹⁾									
• On	ms	< 140				< 140			
• Off	ms	< 35				< 30			

¹⁾ Plus IO-Link communication

Load Feeders and Motor Starters for Use in the Control Cabinet

SIRIUS 3RA6 Compact Starters

General data

Type		3RA61	3RA62	3RA64	3RA65
Control circuit					
Rated operational voltage					
• External auxiliary switch	V	400/690			
• Internal auxiliary switch	V	400/690			
• Short-circuit signaling switch	V	400			
• Overload signaling switch	V	400			
Switching capacity					
• External auxiliary switch					
	AC-15				
	• Up to $U_o = 230$ V	A	6		
	• Up to $U_o = 400$ V	A	3		
	• Up to $U_o = 289/500$ V	A	2		
	• Up to $U_o = 400/690$ V	A	1		
	DC-13				
	• Up to $U_o = 24$ V	A	6		
	• Up to $U_o = 60$ V	A	0.9		
	• Up to $U_o = 125$ V	A	0.55		
	• Up to $U_o = 250$ V	A	0.27		
• Internal auxiliary switch	AC-15				
	• Up to $U_o = 230$ V	A	6		
	• Up to $U_o = 400$ V	A	3		
	• Up to $U_o = 289/500$ V	A	2		
	• Up to $U_o = 400/690$ V	A	1		
	DC-13				
	• Up to $U_o = 24$ V	A	10		
	• Up to $U_o = 60$ V	A	2		
	• Up to $U_o = 125$ V	A	1		
	• Up to $U_o = 250$ V	A	0.27		
	• Up to $U_o = 480$ V	A	0.1		
• Signaling switch	AC-15				
	• Up to $U_o = 230$ V	A	3		
	• Up to $U_o = 400$ V	A	1		
	DC-13				
	• Up to $U_o = 24$ V	A	2		
	• Up to $U_o = 250$ V	A	0.11		
External auxiliary switches, internal auxiliary switches					
Endurance in operating cycles					
• Mechanical endurance		10 000 000		3 000 000	
• Electrical endurance	AC-15, 230 V				
	• Up to 6 A	200 000			
	• Up to 3 A	500 000			
	• Up to 1 A	2 000 000			
	• Up to 0.3 A	10 000 000			
	DC-13, 24 V				
	• Up to 6 A	30 000			
	• Up to 3 A	100 000			
	• Up to 0.5 A	2 000 000			
	• Up to 0.2 A	10 000 000			
	DC-13, 110 V				
	• Up to 1 A	40 000			
	• Up to 0.55 A	100 000			
	• Up to 0.3 A	300 000			
	• Up to 0.1 A	2 000 000			
	• Up to 0.04 A	10 000 000			
	DC-13, 220 V				
	• Up to 0.3 A	110 000			
	• Up to 0.1 A	650 000			
	• Up to 0.05 A	2 000 000			
	• Up to 0.018 A	10 000 000			
Contact reliability	At 17 V and 5 mA	Operating cycles	1 faulty switching operation per 100 000 000		
Short-circuit protection					
• Short-circuit current $I_K \leq 1.1$ kA	Fuse links, operational class gG - NEOZED type 5SE - DIAZED type 5SB - LV HRC type 3NA	A	10		
• Short-circuit current $I_K < 400$ A	Miniature circuit breaker up to 230 V with C characteristic	A	10		

Load Feeders and Motor Starters for Use in the Control Cabinet

SIRIUS 3RA6 Compact Starters

General data

Type			3RA61	3RA62	3RA64	3RA65
Signaling switches						
Endurance in operating cycles						
<ul style="list-style-type: none"> • Mechanical endurance • Electrical endurance AC-15 	At 230 V and 3 A		20 000			
			6 050			
Contact reliability	At 17 V and 5 mA	Oper- ating cycles	1 faulty switching operation per 100 000 000			
Short-circuit protection						
<ul style="list-style-type: none"> • Short-circuit current $I_K \leq 1.1$ kA 	Fuse links, operational class gG - NEOZED type 5SE - DIAZED type 5SB - LV HRC type 3NA	A	6			
<ul style="list-style-type: none"> • Short-circuit current $I_K < 400$ A 	Miniature circuit breaker up to 230 V with C characteristic	A	6			
Overload (short-circuit current $I_K \leq 1.1$ kA)	Fuse links, operational class gG - NEOZED type 5SE - DIAZED type 5SB - LV HRC type 3NA	A	4			



Load Feeders and Motor Starters for Use in the Control Cabinet

SIRIUS 3RA6 Compact Starters

3RA61, 3RA62 compact starters > 3RA61 direct-on-line starters **IE3/IE4 ready**

Selection and ordering data



Direct-on-line start

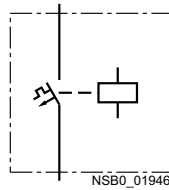

Width 45 mm

Rated short-circuit current $I_{CS} = 53 \text{ kA}$ at 400 V

A set of 3RA6940-0A adapters is required for screw fixing.

PU (UNIT, SET, M) = 1
PS* = 1 unit
PG = 42F

3RA6120-1CB32

3RA6120-2EB32

Standard three-phase motor 4-pole at 400 V AC ¹⁾ Standard output P	Setting range for electronic overload release	Instantaneous electronic release	SD ²⁾	Article No.	Price per PU	SD ²⁾	Article No.	Price per PU
kW	A	A	d			d		

For use with the infeed system for 3RA6 and with the AS-i add-on module or as a replacement device, without main and control circuit terminals

0.09	0.1 ... 0.4	56	10	3RA6120-0A□30	--	--		
0.37	0.32 ... 1.25	56	10	3RA6120-0B□30	--	--		
1.5	1 ... 4	56	2	3RA6120-0C□30	--	--		
5.5	3 ... 12	168	2	3RA6120-0D□30	--	--		
15	8 ... 32	448	2	3RA6120-0E□30	--	--		

Screw terminals



Spring-loaded terminals



For standard mounting rail or screw fixing, including 1 pair of main circuit terminals and 1 pair of control circuit terminals

0.09	0.1 ... 0.4	56	2	3RA6120-1A□32	2	3RA6120-2A□32		
0.37	0.32 ... 1.25	56	2	3RA6120-1B□32	2	3RA6120-2B□32		
1.5	1 ... 4	56	2	3RA6120-1C□32	2	3RA6120-2C□32		
5.5	3 ... 12	168	2	3RA6120-1D□32	2	3RA6120-2D□32		
15	8 ... 32	448	2	3RA6120-1E□32	2	3RA6120-2E□32		

For use in the infeed system for 3RA6, without main circuit terminals, with 1 pair of control circuit terminals

0.09	0.1 ... 0.4	56	10	3RA6120-1A□33	10	3RA6120-2A□33		
0.37	0.32 ... 1.25	56	2	3RA6120-1B□33	10	3RA6120-2B□33		
1.5	1 ... 4	56	2	3RA6120-1C□33	2	3RA6120-2C□33		
5.5	3 ... 12	168	2	3RA6120-1D□33	2	3RA6120-2D□33		
15	8 ... 32	448	2	3RA6120-1E□33	2	3RA6120-2E□33		

Article No. supplements for rated control supply voltage

- 24 V AC/DC
- 110 ... 240 V AC/DC

For standard mounting rail or screw fixing for use with AS-i add-on module, with 1 pair of main circuit terminals, without control circuit terminals
Rated control supply voltage 24 V AC/DC

0.09	0.1 ... 0.4	56	10	3RA6120-1AB34	10	3RA6120-2AB34		
0.37	0.32 ... 1.25	56	10	3RA6120-1BB34	10	3RA6120-2BB34		
1.5	1 ... 4	56	10	3RA6120-1CB34	10	3RA6120-2CB34		
5.5	3 ... 12	168	2	3RA6120-1DB34	10	3RA6120-2DB34		
15	8 ... 32	448	10	3RA6120-1EB34	10	3RA6120-2EB34		

¹⁾ The actual starting and rated data of the motor to be protected must be considered when selecting the units.

²⁾ Standard delivery times apply for a rated control supply voltage of 24 V AC/DC. For the other rated control supply voltages, longer delivery times are possible.

Load Feeders and Motor Starters for Use in the Control Cabinet

SIRIUS 3RA6 Compact Starters

IE3/IE4 ready 3RA61, 3RA62 compact starters > 3RA62 reversing starters

Selection and ordering data



Reversing duty

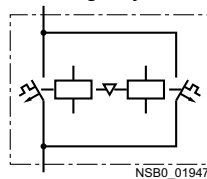

Width 90 mm

Rated short-circuit current $I_{CS} = 53 \text{ kA}$ at 400 V

Two sets of 3RA6940-0A adapters are required for screw fixing.

 PU (UNIT, SET, M) = 1
 PS* = 1 unit
 PG = 42F

3RA6250-1CP32

3RA6250-2DP32

Standard three-phase motor 4-pole at 400 V AC ¹⁾ Standard output P	Setting range for electronic overload release	Instantaneous electronic release	SD ²⁾	Article No.	Price per PU	SD ²⁾	Article No.	Price per PU
kW	A	A	d			d		

**For use with the infeed system for 3RA6
and with the AS-i add-on module or as a replacement device,
without main and control circuit terminals**

0.09	0.1 ... 0.4	56	10	3RA6250-0A□30				
0.37	0.32 ... 1.25	56	10	3RA6250-0B□30				
1.5	1 ... 4	56	10	3RA6250-0C□30				
5.5	3 ... 12	168	10	3RA6250-0D□30				
15	8 ... 32	448	10	3RA6250-0E□30				

Screw terminals

Spring-loaded
terminals
**For standard mounting rail or screw fixing,
including 1 pair of main circuit terminals and 1 pair of control circuit terminals**

0.09	0.1 ... 0.4	56	10	3RA6250-1A□32	10	3RA6250-2A□32
0.37	0.32 ... 1.25	56	2	3RA6250-1B□32	2	3RA6250-2B□32
1.5	1 ... 4	56	2	3RA6250-1C□32	2	3RA6250-2C□32
5.5	3 ... 12	168	2	3RA6250-1D□32	2	3RA6250-2D□32
15	8 ... 32	448	2	3RA6250-1E□32	10	3RA6250-2E□32

**For use in the infeed system for 3RA6,
without main circuit terminals, with 1 pair of control circuit terminals**

0.09	0.1 ... 0.4	56	10	3RA6250-1A□33	10	3RA6250-2A□33
0.37	0.32 ... 1.25	56	10	3RA6250-1B□33	10	3RA6250-2B□33
1.5	1 ... 4	56	10	3RA6250-1C□33	10	3RA6250-2C□33
5.5	3 ... 12	168	10	3RA6250-1D□33	10	3RA6250-2D□33
15	8 ... 32	448	10	3RA6250-1E□33	10	3RA6250-2E□33

Article No. supplements for rated control supply voltage

- 24 V AC/DC
- 110 ... 240 V AC/DC

B
PB
P
**For standard mounting rail or screw fixing
for use with AS-i add-on module,
with 1 pair of main circuit terminals, without control circuit terminals**
 Rated control supply voltage 24 V AC/DC

0.09	0.1 ... 0.4	56	10	3RA6250-1AB34	10	3RA6250-2AB34
0.37	0.32 ... 1.25	56	10	3RA6250-1BB34	10	3RA6250-2BB34
1.5	1 ... 4	56	10	3RA6250-1CB34	10	3RA6250-2CB34
5.5	3 ... 12	168	10	3RA6250-1DB34	10	3RA6250-2DB34
15	8 ... 32	448	10	3RA6250-1EB34	10	3RA6250-2EB34

¹⁾ The actual starting and rated data of the motor to be protected must be considered when selecting the units.

²⁾ Standard delivery times apply for a rated control supply voltage of 24 V AC/DC. For the other rated control supply voltages, longer delivery times are possible.

Load Feeders and Motor Starters for Use in the Control Cabinet

SIRIUS 3RA6 Compact Starters

3RA64, 3RA65 compact starters for IO-Link > 3RA64 direct-on-line starters

IE3/IE4 ready**Selection and ordering data**

3RA64 with 3RA6911-1A auxiliary switch

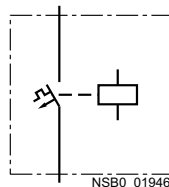
Direct-on-line start**Rated control supply voltage 24 V DC**

Width 45 mm

Rated short-circuit current $I_{CS} = 53 \text{ kA}$ at 400 V

A set of 3RA6940-0A adapters is required for screw fixing.

PU (UNIT, SET, M) = 1
 PS* = 1 unit
 PG = 42F

Standard three-phase motor 4-pole at 400 V AC ¹⁾ Standard output P	Setting range for electronic overload release	Instantaneous electronic release	SD	Article No.	Price per PU	SD	Article No.	Price per PU
kW	A	A	d	Screw terminals		d	Spring-loaded terminals	
For standard mounting rail or screw fixing, including 1 pair of main circuit terminals and 1 pair of control circuit terminals								
0.09	0.1 ... 0.4	56	10	3RA6400-1AB42		10	3RA6400-2AB42	
0.37	0.32 ... 1.25	56	10	3RA6400-1BB42		10	3RA6400-2BB42	
1.5	1 ... 4	56	2	3RA6400-1CB42		2	3RA6400-2CB42	
5.5	3 ... 12	168	2	3RA6400-1DB42		2	3RA6400-2DB42	
15	8 ... 32	448	10	3RA6400-1EB42		10	3RA6400-2EB42	
For use in the infeed system for 3RA6, without main circuit terminals, with 1 pair of control circuit terminals								
0.09	0.1 ... 0.4	56	10	3RA6400-1AB43		10	3RA6400-2AB43	
0.37	0.32 ... 1.25	56	2	3RA6400-1BB43		2	3RA6400-2BB43	
1.5	1 ... 4	56	2	3RA6400-1CB43		2	3RA6400-2CB43	
5.5	3 ... 12	168	2	3RA6400-1DB43		2	3RA6400-2DB43	
15	8 ... 32	448	10	3RA6400-1EB43		10	3RA6400-2EB43	

¹⁾ The actual starting and rated data of the motor to be protected must be considered when selecting the units.

Load Feeders and Motor Starters for Use in the Control Cabinet

SIRIUS 3RA6 Compact Starters

IE3/IE4 ready 3RA64, 3RA65 compact starters for IO-Link > 3RA65 reversing starters

Selection and ordering data



3RA65 with 3RA6911-1A auxiliary switch

Reversing duty

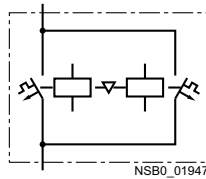

Rated control supply voltage 24 V DC

Width 90 mm

 Rated short-circuit current $I_{CS} = 53 \text{ kA}$ at 400 V

Two sets of 3RA6940-0A adapters are required for screw fixing.

 PU (UNIT, SET, M) = 1
 PS* = 1 unit
 PG = 42F

Standard three-phase motor 4-pole at 400 V AC ¹⁾ Standard output P	Setting range for electronic overload release	Instantaneous electronic release	SD	Article No.	Price per PU	SD	Article No.	Price per PU
kW	A	A	d	Screw terminals		d	Spring-loaded terminals	
For standard mounting rail or screw fixing, including 1 pair of main circuit terminals and 1 pair of control circuit terminals								
0.09	0.1 ... 0.4	56	10	3RA6500-1AB42	10	3RA6500-2AB42		
0.37	0.32 ... 1.25	56	2	3RA6500-1BB42	10	3RA6500-2BB42		
1.5	1 ... 4	56	2	3RA6500-1CB42	10	3RA6500-2CB42		
5.5	3 ... 12	168	10	3RA6500-1DB42	10	3RA6500-2DB42		
15	8 ... 32	448	10	3RA6500-1EB42	10	3RA6500-2EB42		
For use in the infeed system for 3RA6, without main circuit terminals, with 1 pair of control circuit terminals								
0.09	0.1 ... 0.4	56	10	3RA6500-1AB43	10	3RA6500-2AB43		
0.37	0.32 ... 1.25	56	10	3RA6500-1BB43	10	3RA6500-2BB43		
1.5	1 ... 4	56	10	3RA6500-1CB43	10	3RA6500-2CB43		
5.5	3 ... 12	168	10	3RA6500-1DB43	10	3RA6500-2DB43		
15	8 ... 32	448	10	3RA6500-1EB43	10	3RA6500-2EB43		

¹⁾ The actual starting and rated data of the motor to be protected must be considered when selecting the units.

Load Feeders and Motor Starters for Use in the Control Cabinet

SIRIUS 3RA6 Compact Starters

Accessories

Overview

Accessories for SIRIUS 3RA6 compact starters

The following accessories are available specially for the 3RA6 compact starters:

- Infeed system for 3RA6, [see page 8/78 onwards](#)
- For AS-i add-on modules, [see page 8/76 onwards: "Add-on modules for AS-Interface"](#)
- External auxiliary switches: Snap-on auxiliary switch as versions 2 NO, 2 NC and 1 NO + 1 NC with screw or spring-loaded terminals; the contacts of the auxiliary switch open and close jointly with the main contacts of the compact starter. The NC contacts are designed as mirror contacts.
- Control kit: Aid for manually closing the main contacts to check the wiring and motor direction under conditions of short-circuit protection
- Adapter for screw fixing the compact starter, including push-in lugs
- Main circuit terminal: Available with screw and spring-loaded terminals
- Main circuit terminals mixed connection method: With the main circuit terminals mixed connection method it is also possible in the main circuit to switch from screw terminals on the line side to spring-loaded terminals on the outgoing side. This enables, for example, the side-by-side mounting of several compact starters and their cost-efficient connection using three-phase busbars on the infeed side. The motors are then connected directly by the quick and reliably contacting spring-loaded terminals.

Accessories for UL applications

The terminal block for "Self-Protected Combination Motor Controller (Type E)" is available for complying with the clearances and creepage distances demanded according to UL 508.

Accessories for infeed using three-phase busbar systems

The three-phase busbars can be used as an easy, time-saving and clearly arranged means of feeding SIRIUS 3RA6 compact starters with screw terminals. Motor starter protector sizes S00 and S0 can also be integrated.

The busbars are suitable for between two and five devices. However, any kind of extension up to a maximum summation current of 63 A is possible by clamping the tags of an additional busbar (rotated by 180°) underneath the terminals of the respective last motor starter protector.

Motor starter protectors S00 and S0 of the 3RV2 series can be combined in any way (without a special connecting piece). The motor starter protectors are supplied by appropriate infeed terminals. Special infeed terminals are required for constructing "Starters (Type E)" according to UL/CSA.

The three-phase busbar systems are finger-safe but empty connection tags must be fitted with covers. They are designed for any short-circuit stress which can occur at the output side of connected SIRIUS 3RA6 compact starters or motor starter protectors.

Busbar adapters for 60 mm systems

The compact starters are mounted directly with the aid of busbar adapters on busbar systems with 60 mm center-to-center clearance in order to save space and to reduce infeed times and costs. These feeders are suitable for copper busbars with a width from 12 to 30 mm. The busbars can be 4 to 5 mm or 10 mm thick.

The 8US busbar system can be loaded with a maximum summation current of 630 A.

The "reversing starter" version requires a device holder alongside the busbar adapter for lateral mounting.

The compact starters are snapped onto the adapter and connected on the line side. This prepared unit is then plugged directly onto the busbar system, and is thus connected both mechanically and electrically at the same time.

For more accessories such as incoming and outgoing terminals, flat copper profiles, etc., [see Catalog LV 10](#).

Accessories for operation with closed control cabinet doors

Door-coupling rotary operating mechanisms for standard and EMERGENCY STOP applications are available for operating the compact starter with closed control cabinet doors.

Accessories for SIRIUS 3RA6 compact starters in IO-Link version

The following accessories are available specially for the 3RA64, 3RA65 compact starters:







- Additional connection cables for side-by-side mounting of up to four compact starters
- Operator panel for on-site control and diagnostics of up to four compact starters coupled to each other

Load Feeders and Motor Starters for Use in the Control Cabinet

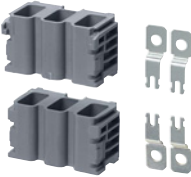
SIRIUS 3RA6 Compact Starters

Accessories

Selection and ordering data

Version	SD	Article No.	Price per PU	PU (UNIT, SET, M)	PS*	PG
Accessories specially for 3RA6 compact starters						
		Control kit For mechanical actuation of the compact starter				
3RA6950-0A	2	3RA6950-0A		1	1 unit	42F
		Adapters for screw fixing the compact starter (set including push-in lugs) Direct-on-line starters require one set, reversing starters two sets.				
3RA6940-0A	2	3RA6940-0A		1	1 unit	42F
		Auxiliary switches for compact starters				
3RA6911-1A	2	• 2 NO • 2 NC • 1 NO + 1 NC (these auxiliary contacts are positively driven)				
		Main circuit terminals (incoming and outgoing side)				
3RA6920-1A	2	3RA6920-1A		1	1 unit	42F
		Control circuit terminals (1 set comprising 2 terminals) • for 3RA61 • for 3RA62				
3RA6920-1B	2	3RA6920-1B 3RA6920-1C		1	1 unit	42F
		Auxiliary switches for compact starters				
3RA6911-2A	2	• 2 NO • 2 NC • 1 NO + 1 NC (these auxiliary contacts are positively driven)				
		Main circuit terminals (incoming and outgoing side)				
3RA6920-2A	2	3RA6920-2A		1	1 unit	42F
		Control circuit terminals (1 set comprising 2 terminals) • for 3RA61 • for 3RA62				
3RA6920-2B	2	3RA6920-2B 3RA6920-2C		1	1 unit	42F

Load Feeders and Motor Starters for Use in the Control Cabinet

SIRIUS 3RA6 Compact Starters

Accessories

Version	SD	Article No.	Price per PU	PU (UNIT, SET, M)	PS*	PG
	d					

Accessories specially for 3RA6 compact starters (continued)



3RA6920-3A

Main circuit terminals, mixed connection method

1 set comprises:

- 1 joint block on the line side with screw terminals
- 1 joint block on the outgoing side with spring-loaded terminals

20		3RA6920-3A		1	1 unit	42F
----	--	-------------------	--	---	--------	-----

Version	SD	Article No.	Price per PU	PU (UNIT, SET, M)	PS*	PG
	d					

Accessories specially for 3RA64, 3RA65 compact starters for IO-Link



3RA6931-0A

Additional connection cables (flat) for side-by-side mounting of up to 4 compact starters

- 10-pole
- 8 mm¹⁾
- 200 mm¹⁾
- 14-pole
- 8 mm²⁾
- 200 mm

2		3RA6932-0A		1	5 units	42F
5		3RA6933-0B		1	5 units	42F

5		3RA6931-0A		1	5 units	42F
5		3RA6933-0C		1	5 units	42F



3RA6935-0A

Operator panels (set)

- 1 operator panel
- 1 enabling module
- 1 interface cover
- 1 fixing terminal

10		3RA6935-0A		1	1 unit	42F
----	--	-------------------	--	---	--------	-----

Enabling modules (replacement)

10		3RA6936-0A		1	1 unit	42F
----	--	-------------------	--	---	--------	-----

Interface covers (replacement)

10		3RA6936-0B		1	5 units	42F
----	--	-------------------	--	---	---------	-----

Connection cables (round)

For connecting the operator panel
10-pole, 2 000 mm

5		3RA6933-0A		1	1 unit	42F
---	--	-------------------	--	---	--------	-----

1) 10-pole connection cables are required for EMERGENCY STOP group concepts.

2) Is included in the scope of supply of the SIRIUS 3RA6 compact starter in IO-Link version.

For matching IO-Link masters, [see page 2/102 onwards](#).

Version	SD	Article No.	Price per PU	PU (UNIT, SET, M)	PS*	PG
	d					

Terminals for "Self-Protected Combination Motor Controllers (Type E)" acc. to UL 508 for infeed through parallel wiring with compact starters



3RV2928-1H

Terminal blocks (Type E)

For extended clearances and creepage distances (1 and 2 inch)

Note:

UL 508 demands 1-inch clearance and 2-inch creepage distance at line side for "Combination Motor Controller (Type E)". Terminal blocks are not required for use according to CSA. These terminal blocks cannot be used in combination with 3RV19.5 three-phase busbars.

▶		3RV2928-1H		1	1 unit	41E
---	--	-------------------	--	---	--------	-----





Load Feeders and Motor Starters for Use in the Control Cabinet

SIRIUS 3RA6 Compact Starters

Accessories

Number of compact starters and motor starter protectors that can be connected Without lateral accessories	Modular spacing	Rated current I_n at 690 V	For motor starter protectors	SD	Article No.	Price per PU	PU (UNIT, SET, M)	PS*	PG

Three-phase busbars for infeed with 3RA6

	For feeding several compact starters and/or motor starter protectors with screw terminals, mounted side-by-side on standard mounting rails, insulated, with touch protection.												
3RV1915-1AB	2	45	63	S00, S0 ¹⁾						3RV1915-1AB	1	1 unit	41E
	3	45	63	S00, S0 ¹⁾						3RV1915-1BB	1	1 unit	41E
3RV1915-1BB	4	45	63	S00, S0 ¹⁾						3RV1915-1CB	1	1 unit	41E
	5	45	63	S00, S0 ¹⁾						3RV1915-1DB	1	1 unit	41E
3RV1915-1CB													
													
3RV1915-1DB													

¹⁾ Not suitable for 3RV21 motor starter protectors for motor protection with overload relay function and for 3RV27 and 3RV28 circuit breakers according to UL 489/CSA C22.2 No. 5.

Version	Modular spacing	For motor starter protectors	SD	Article No.	Price per PU	PU (UNIT, SET, M)	PS*	PG
	mm	Size	d					

Covers for connection tags of the three-phase busbars

	Touch protection for empty positions	--	S00, S0	▶	3RV1915-6AB	1	10 units	41E
3RV1915-6AB								

Conductor cross-section			Tightening torque	For compact starters and motor starter protectors	SD	Article No.	Price per PU	PU (UNIT, SET, M)	PS*	PG
Solid or stranded	Finely stranded with end sleeve	AWG cables, solid or stranded								
mm ²	mm ²	AWG	Nm	Size	d					

Three-phase infeed terminals for three-phase busbars and for constructing "Starters (Type E)" according to UL 508

	Connection from top									
3RV2925-5EB	2.5 ... 25	2.5 ... 16	10 ... 4	3 ... 4						S00, S0

Three-phase infeed terminals for three-phase busbars

	Connection from below¹⁾									
3RV2915-5B	2.5 ... 25	2.5 ... 16	10 ... 4	Input: 4; Output: 2 ... 2.5						S00, S0

¹⁾ This terminal is connected in place of a compact starter, please take the space requirement (45 mm) into account.

Load Feeders and Motor Starters for Use in the Control Cabinet

SIRIUS 3RA6 Compact Starters

Accessories

Version	SD	Article No.	Price per PU	PU (UNIT, SET, M)	PS*	PG
	d					

Busbar adapters for 60 mm systems



8US1211-1NS10

For flat copper profiles according to DIN 46433
Width: 12 ... 30 mm
Thickness: 4 ... 5 mm or 10 mm

2

8US1211-1NS10

1

1 unit

140

Device holders for lateral mounting alongside the busbar adapter for 60 mm systems



8US1250-1AA10

Required in addition to the busbar adapter for mounting a reversing starter

2

8US1250-1AA10

1

1 unit

140

Version	Color of actuator	Version of extension shaft mm	SD	Article No.	Price per PU	PU (UNIT, SET, M)	PS*	PG
			d					

Door-coupling rotary operating mechanisms for operating the compact starter with closed control cabinet doors



3RV2926-0B

The door-coupling rotary operating mechanisms consist of a knob, a coupling driver and a 130 mm long extension shaft (6 mm x 6 mm). The door-coupling rotary operating mechanisms are designed to degree of protection IP64. The door interlocking prevents accidental opening of the control cabinet door in the ON position of the motor starter protector. The OFF position can be locked with up to 3 padlocks.

Door-coupling rotary operating mechanisms

Black

130

▶

3RV2926-0B

1

1 unit

41E

EMERGENCY STOP door-coupling rotary operating mechanisms

Red/yellow

130

▶

3RV2926-0C



1

1 unit

41E

Load Feeders and Motor Starters for Use in the Control Cabinet SIRIUS 3RA6 Compact Starters

Accessories

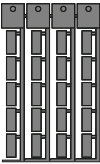
Version	SD	Article No.	Price per PU	PU (UNIT, SET, M)	PS*	PG
Tools for opening spring-loaded terminals						
 Screwdrivers For all SIRIUS devices with spring-loaded terminals Length approx. 200 mm, 3.0 mm x 0.5 mm, titanium gray/black, partially insulated 3RA2908-1A	2	Spring-loaded terminals  3RA2908-1A		1	1 unit	41B
	Blank labels					
 Unit labeling plates¹⁾ For SIRIUS devices 20 mm x 7 mm, titanium gray 3RT2900-1SB20	20	3RT2900-1SB20		100	340 units	41B
	System Manual					
"SIRIUS 3RA6 Compact Starter, SIRIUS Infeed System for 3RA6"						
System Manual, see http://support.industry.siemens.com/cs/ww/en/view/27865747 .						

¹⁾ PC labeling system for individual inscription of unit labeling plates available from: murrplastik Systemtechnik GmbH (see page 16/15).

Load Feeders and Motor Starters for Use in the Control Cabinet

SIRIUS 3RA6 Compact Starters

Add-on modules for AS-Interface

Overview

Various AS-i add-on modules are available for communication of the 3RA6 compact starter with the control system using AS-Interface:

- Standard version
- With two local inputs
- With two free external inputs
- With one free external input and one free external output
- With two free external outputs
- For local control

The AS-i add-on modules can be combined only in connection with compact starters with a rated control supply voltage of 24 V AC/DC.

AS-i add-on module for local control

With this new module it is also possible for the connected compact starter to be operated directly using simple switches, i.e. without recourse to AS-i communication, if required.

"Automatic" mode

NC contacts can be connected to the inputs Y2 and Y4 through the local terminals on the AS-i add-on module. If the "+" terminals are connected simultaneously to both local inputs, the AS-i add-on module will be in "Automatic" mode, i.e. it will communicate with the control system through AS-Interface.

Local control

Opening the two inputs Y2 and Y4 will result in the direct disconnection of the compact starter. Operation through AS-i communication is finished and the compact starter can now be switched on and off directly using NO contacts (one NO contact per direction of rotation on the reversing starter).

"LED AUX Power" must light up green, the 24 V DC supply must be ensured and the AS-i control supply voltage must no longer be applied.

Resetting to "Automatic" mode

If a "1" signal is simultaneously applied at the local inputs, the availability bit DI 0 is switched to a "1" signal.

If AS-i communication is reset, the motor is first switched off and then on again when requested by the control system.

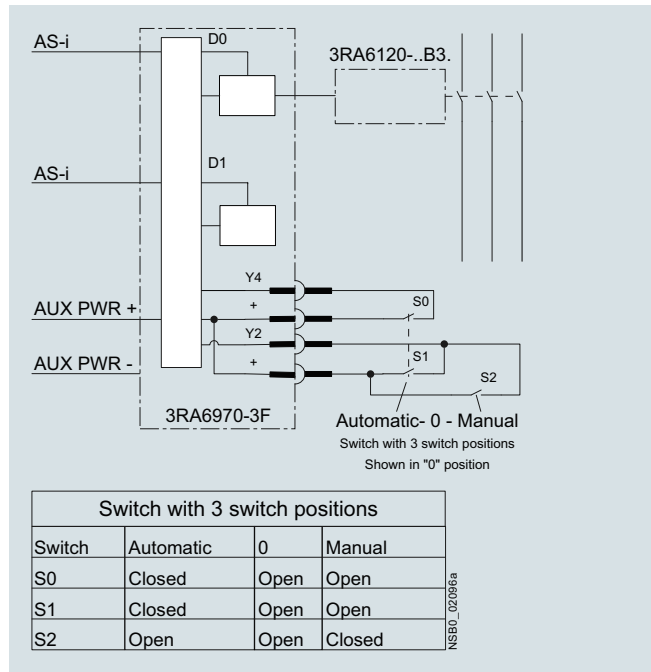

Circuit diagram example for controlling a 3RA6120 direct-on-line starter using an AS-i add-on module for local control

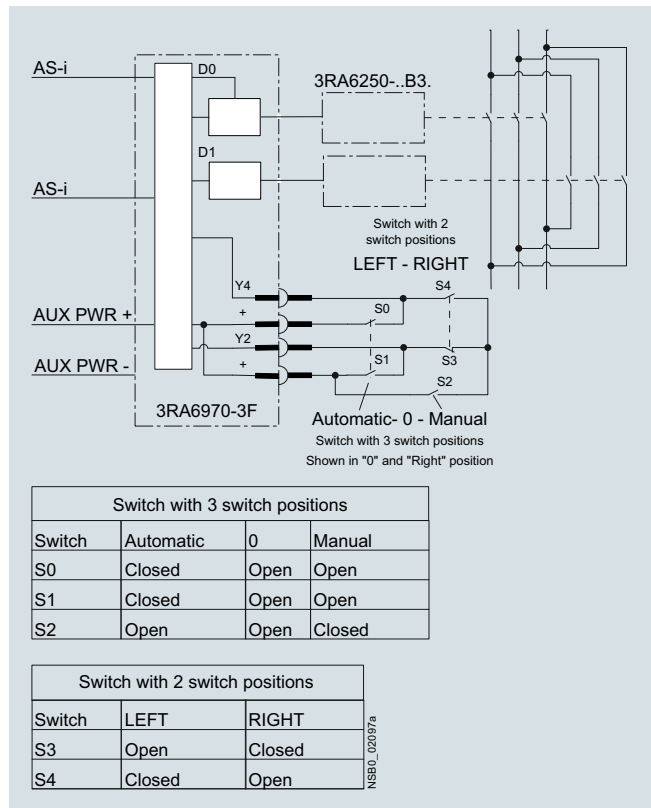





Circuit diagram example for controlling a 3RA6250 reversing starter using an AS-i add-on module for local control

Load Feeders and Motor Starters for Use in the Control Cabinet

SIRIUS 3RA6 Compact Starters

Add-on modules for AS-Interface

Selection and ordering data

Version	SD	Article No.	Price per PU	PU (UNIT, SET, M)	PS*	PG
AS-i add-on modules						
 3RA6970-3A  3RA6970-3B to -3F		Standard version	2	3RA6970-3A	1	1 unit 42F
		For communication of the compact starter with the control system using AS-Interface				
		With two local inputs	2	3RA6970-3B	1	1 unit 42F
		For safe disconnection through local safety relays, e.g. cable-operated switches				
		With two free external inputs	2	3RA6970-3C	1	1 unit 42F
		Replaces the digital standard inputs "Motor On" and "Group warning"				
	With one free external input and one free external output	2	3RA6970-3D	1	1 unit 42F	
	Replaces the digital standard input "Group warning"					
	With two free external outputs	2	3RA6970-3E	1	1 unit 42F	
	Only for direct-on-line starters, replaces the digital standard output "Motor CCW"					
	For local control	2	3RA6970-3F	1	1 unit 42F	
	Control of the compact starter optionally using AS-Interface or local switches					
Spare parts for AS-i add-on modules						
  3RK1901-0NA00, 3RK1901-0PA00		Connection plugs for data and auxiliary supply cable				
		With 2 insulation displacement terminations for standard stranded wires 2 x 0.5 ... 0.75 mm ²				
	• Flat, yellow, extender	10	3RK1901-0NA00	1	5 units 42C	
	• Flat, black, extender	10	3RK1901-0PA00	1	5 units 42C	
Accessories for AS-i add-on modules						
 3RK1904-2AB02		AS-Interface addressing unit V3.0	2	3RK1904-2AB02	1	1 unit 42C
		<ul style="list-style-type: none"> • For AS-Interface modules and sensors and actuators with integrated AS-Interface according to AS-i specification V3.0 • For setting the AS-i address of standard slaves, and slaves with extended addressing mode (A/B slaves) • With input/output test function and many other commissioning functions • Battery operation with four type AA batteries (IEC LR6, NEDA 15) • Scope of supply: <ul style="list-style-type: none"> - Addressing unit with four batteries - Addressing cable, with M12 plug to addressing plug (hollow plug), length 1.5 m 				

For matching AS-Interface masters, network transitions and power supply units, see pages 2/32, 2/39 and 2/73 onwards.

Load Feeders and Motor Starters for Use in the Control Cabinet

SIRIUS 3RA6 Compact Starters

Infeed system for 3RA6

Overview

More information

Homepage, see www.siemens.com/compactstarter
 Industry Mall, see www.siemens.com/product?3RA68

Online configurator, see www.siemens.com/sirius/configurators

The infeed system for 3RA6 compact starters enables far less wiring in the main circuit and, thanks to the easy exchangeability of the compact starters, reduces the usual downtimes for maintenance work during the plant's operating phase. The infeed system provides the possibility of completely

prewiring the main circuit without a compact starter needing to be connected at the same time. As the result of the removable terminals in the main circuit, compact starters can be integrated in an infeed system in easy manner (without the use of tools).

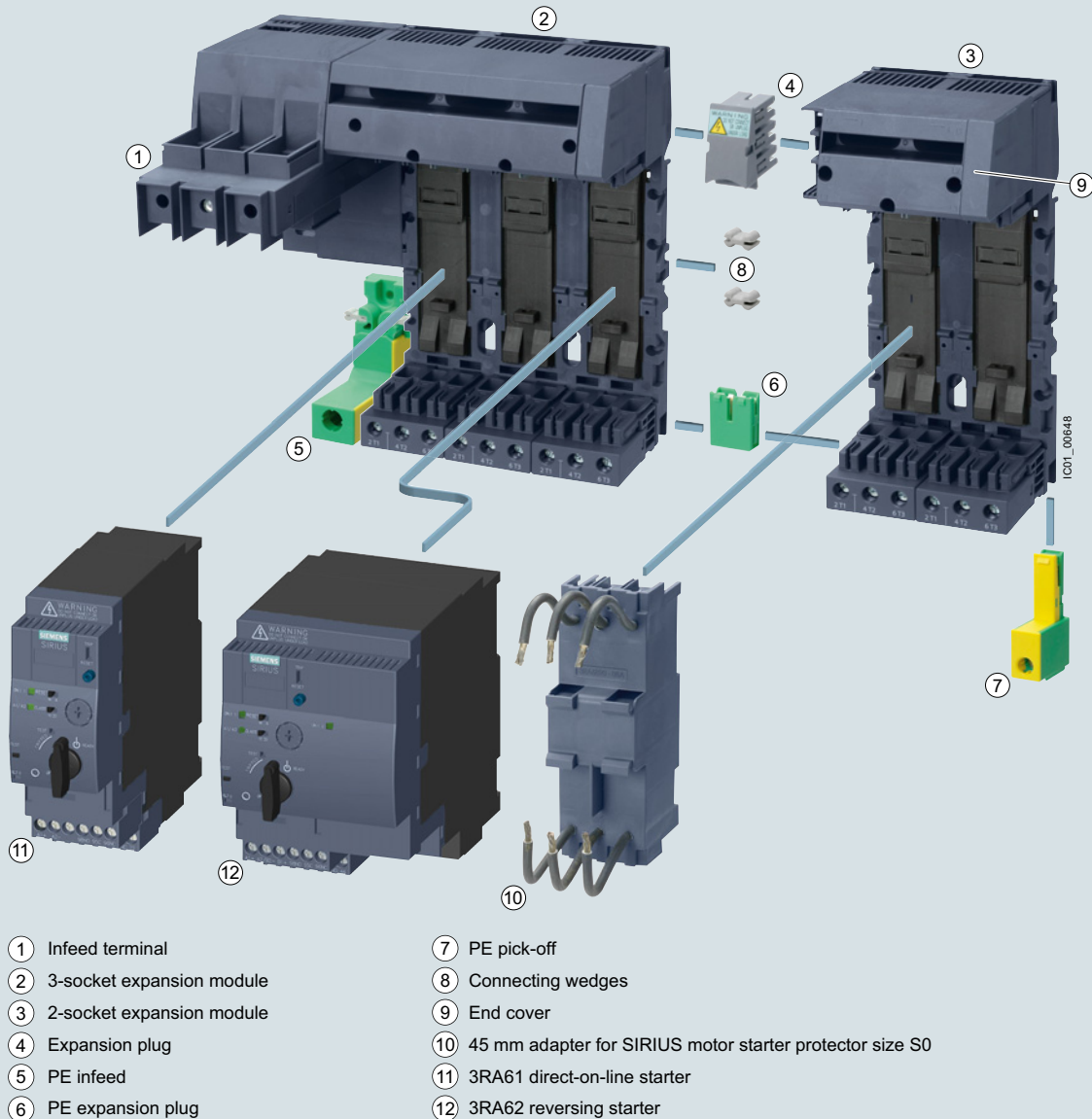

Infeed system for 3RA6 compact starters

Load Feeders and Motor Starters for Use in the Control Cabinet

SIRIUS 3RA6 Compact Starters

Infeed system for 3RA6

In addition, the integrated PE bar means it is optionally possible to connect the motor cable directly to the infeed system without additional intermediate terminals. The infeed system for 3RA6 compact starters is designed for summation currents up to 100 A with a maximum conductor cross-section of up to 70 mm² on the infeed terminal block.

The infeed system can be mounted on a standard mounting rail or flat surfaces.

① Infeed

The three-phase infeed is available as an infeed with screw terminal (25/35 mm² up to 63 A or 50/70 mm² up to 100 A) and as an infeed with spring-loaded terminal (25/35 mm² up to 63 A).

The infeed with spring-loaded terminal can be fitted on the left as well as on the right of an expansion module.

The infeed with screw terminal is supplied only with a 3-socket expansion module and permanently fitted on the left side.

The infeeds with screw terminal enable connection of the main conductors (L1, L2, L3) either from above or from below.

The infeed with screw terminal is supplied complete with one end cover, the infeed with spring-loaded terminal complete with two end covers.

② 3-socket expansion module

The expansion module with three sockets for compact starters is available with screw terminals and with spring-loaded terminals.

Expansion modules enable the infeed system to be expanded and can be fitted to each other in any number.

Two expansion modules are held together with the help of two connecting wedges and one expansion plug. These assembly parts are included in the scope of supply of the respective expansion module.

When the infeed system for 3RA6 is used, the compact starters (plug-in modules) are easily assembled and disassembled even when live.

Optional possibilities:

- PE connection on motor outgoing side
- Outfeed for external auxiliary devices
- Connection to 3RV29 infeed system
- Integration of SIRIUS 3RV1 and 3RV2 motor starter protectors size S0 up to 25 A (using 3RA6890-0BA adapter)

③ 2-socket expansion module

If only two instead of three additional sockets are required, then the 2-socket expansion module is the right choice. It has the same functionality as the 3-socket expansion module.

④ Expansion plug

Two expansion modules can be connected together using the expansion plug. Flexible expansion of the infeed system is thus possible.

⑤ PE infeed

This module enables a PE cable to be connected.

The PE infeed can be ordered with screw terminals and spring-loaded terminals (35 mm²) and can be fitted on the left or right of the expansion block.

⑥ PE expansion plug

The PE expansion plug is inserted from below and enables two PE bars to be connected.

⑦ PE pick-off

The PE pick-off is available with screw terminals and spring-loaded terminals (6/10 mm²). It is snapped into the infeed system from below.

⑧ Connecting wedges

Two connecting wedges are used to hold together two expansion modules.

⑨ End covers

On the last expansion module of a row, the socket provided for the expansion plug can be covered by inserting the end cover.

⑩ 45 mm adapters for SIRIUS 3RV1/3RV2 motor starter protectors

SIRIUS 3RV1 and 3RV2 motor starter protectors size S0 with screw terminals can be fitted to the adapter, enabling them to be plugged into the infeed system.

IP20 terminal covers for increasing finger-safety

Universally configured terminal covers are available for the 25/35 mm² and 50/70 mm² three-phase infeeds with screw terminal:

- 3RA6880-2AB terminal covers for infeeds with screw terminal 25/35 mm² (3RA6812-8AB/AC)
- 3RA6880-3AB terminal covers for infeeds with screw terminal 50/70 mm² (3RA6813-8AB/AC)

The terminal covers can be used in two ways on the infeed terminals of the infeeds with screw terminal 25/35 mm² and 50/70 mm² (see illustration):

- If the terminals are connected, the cables are also covered:
 - by approx. 14 mm with the 3RA6880-2AB
 - by approx. 18 mm with the 3RA6880-3AB
- On clamping points without connected cables, the covers can be turned once and then pushed over the clamping points for finger-safe covering of the metal parts.

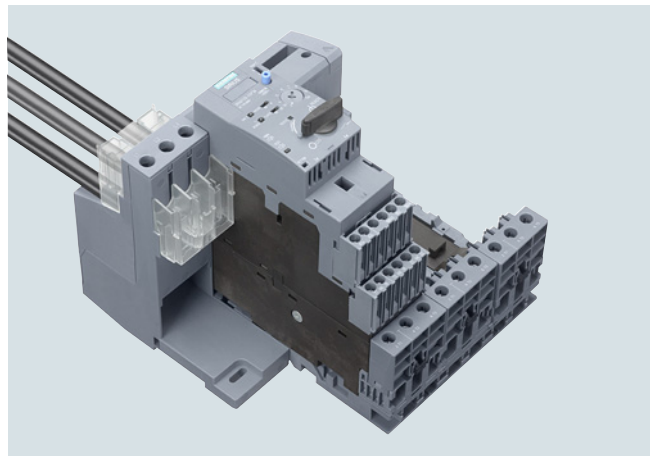

Use of the 3RA6880-2AB terminal cover on the infeed with screw terminal 25/35 mm² (3RA6812-8AB/AC). The upper cover increases the finger-safety for the connected conductors. The identical lower cover is turned for use and prevents touching of the voltage-carrying metal parts of the infeed terminal. For better recognition, the covers are shown as transparent in this illustration and not in their original color.

Load Feeders and Motor Starters for Use in the Control Cabinet

SIRIUS 3RA6 Compact Starters

Infeed system for 3RA6

Terminal blocks

Using the terminal block the three phases can be fed out of the system; this means that single-phase, two-phase and three-phase components can also be integrated in the system.

After the end cover is pulled out, the terminal block can be plugged onto an expansion module.

Expansion plug for SIRIUS 3RV29 infeed systems

After the end cover is pulled out, the expansion plug for the SIRIUS 3RV29 infeed system can be plugged onto an expansion module. It connects the infeed system for 3RA6 compact starters with the SIRIUS 3RV29 infeed system.

Maximum rated operational current

The following maximum rated operational currents apply for the components of the infeed system for 3RA6:

Component	Maximum rated operational current A
Infeed with screw terminal 50/70 mm ²	100
Infeed with screw terminal 25/35 mm ²	63
Infeed with spring-loaded terminal 25/35 mm ²	63
Expansion plug	63

With side-by-side mounting of several expansion modules, the maximum rated operational current from the second expansion module to the end of the row is 63 A.

Proposal for upstream short-circuit protection devices

The following short-circuit data apply for the components of the infeed system for 3RA6 compact starters:

Conductor cross-section mm ²	Maximum let-through current $I_{d, max}$ and current integral I^2t	Proposal for upstream short-circuit protection device	Maximum prospective $I_{short-circuit}$ kA
Short-circuit protection for 3RA681-8A, infeed with screw terminal (25/35 mm² and 50/70 mm²)			
2.5 ... 35, 2.5 ... 70	$I_{d, max} < 21 \text{ kA}$, $I^2t = 530 \text{ kA}^2\text{s}$	3RV2041-4MA10 (LV HRC gG 3NA3; 315 A)	50
Short-circuit protection for infeed with spring-loaded terminal 25/35 mm², 3RA6830-5AC			
4	$I_{d, max} < 9.5 \text{ kA}$, $I^2t = 85 \text{ kA}^2\text{s}$	3RV2021-4DA10	40
6	$I_{d, max} < 12.5 \text{ kA}$, $I^2t = 140 \text{ kA}^2\text{s}$	3RV2031-4EA10	30
10	$I_{d, max} < 15 \text{ kA}$, $I^2t = 180 \text{ kA}^2\text{s}$	3RV2031-4WA10	25
16/25	$I_{d, max} < 19 \text{ kA}$, $I^2t = 440 \text{ kA}^2\text{s}$	3RV2031-4JA10	65
		3RV2041-4JA10	65
35	$I_{d, max} < 21 \text{ kA}$, $I^2t = 530 \text{ kA}^2\text{s}$	3RV2041-4MA10 (LV HRC gG 3NA3; 315 A)	50
Short-circuit protection for terminal block, 3RV2917-5D			
1.5	$I_{d, max} < 7.5 \text{ kA}$	5SY...	
2.5	$I_{d, max} < 9.5 \text{ kA}$	1)	
4	$I_{d, max} < 9.5 \text{ kA}$		
6	$I_{d, max} < 12.5 \text{ kA}$		

1) To prevent the possibility of short circuits, the cables on the terminal block must be installed so that they are short-circuit proof.

Load Feeders and Motor Starters for Use in the Control Cabinet

SIRIUS 3RA6 Compact Starters

Infeed system for 3RA6

Selection and ordering data

Version	SD	Article No.	Price per PU	PU (UNIT, SET, M)	PS*	PG
	d					

Three-phase infeeds and expansion modules

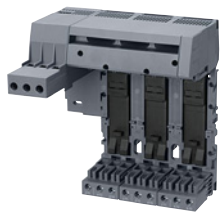

3RA6812-8AB

Infeeds with screw terminal 25/35 mm² left

Infeed with screw terminal at line side with a permanently fitted 3-socket expansion module with screw or spring-loaded terminals on the outgoing side and integrated PE bar

Expansion module with 3 sockets for 3 direct-on-line starters or 1 direct-on-line starter and 1 reversing starter

- Screw terminals on the outgoing side

2

Screw terminals



3RA6812-8AB

1 1 unit

42F

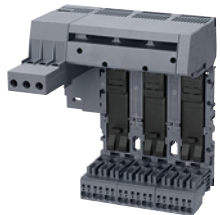

3RA6812-8AC

- Spring-loaded terminals on the outgoing side

2

Spring-loaded terminals



3RA6812-8AC

1 1 unit

42F

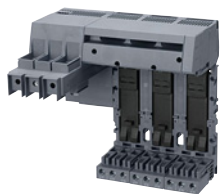

3RA6813-8AB

Infeeds with screw terminal 50/70 mm² left

Infeed with screw terminal at line side with a permanently fitted 3-socket expansion module with screw or spring-loaded terminals on the outgoing side and integrated PE bar

Expansion module with 3 sockets for 3 direct-on-line starters or 1 direct-on-line starter and 1 reversing starter, suitable for UL operation according to UL 508 Type E

- Screw terminals on the outgoing side

2

Screw terminals



3RA6813-8AB

1 1 unit

42F

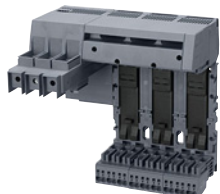

3RA6813-8AC

- Spring-loaded terminals on the outgoing side

2

Spring-loaded terminals



3RA6813-8AC

1 1 unit

42F



3RA6830-5AC

Infeed with spring-loaded terminal 25/35 mm² left or right

Up to 63 A

2

Spring-loaded terminals



3RA6830-5AC

1 1 unit

42F

Load Feeders and Motor Starters for Use in the Control Cabinet

SIRIUS 3RA6 Compact Starters

Infeed system for 3RA6

Version	SD	Article No.	Price per PU	PU (UNIT, SET, M)	PS*	PG
	d					

Expansion modules



3RA6822-0AB

Two-socket expansion modules

With screw or spring-loaded terminals and integrated PE bar

With 2 sockets for 2 direct-on-line starters or 1 reversing starter

Expansion plug and 2 connecting wedges are included in the scope of supply.

- Version with screw terminals

2

Screw terminals



3RA6822-0AB

1

1 unit

42F



3RA6822-0AC

- Version with spring-loaded terminals

2

Spring-loaded terminals



3RA6822-0AC

1

1 unit

42F



3RA6823-0AB

Three-socket expansion modules

With screw or spring-loaded terminals and integrated PE bar

With 3 sockets for 3 direct-on-line starters or 1 direct-on-line starter and 1 reversing starter

Expansion plug and 2 connecting wedges are included in the scope of supply.

- Version with screw terminals

2

Screw terminals



3RA6823-0AB

1

1 unit

42F

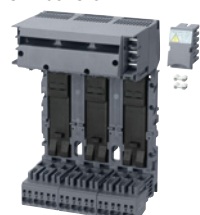

3RA6823-0AC

- Version with spring-loaded terminals

2

Spring-loaded terminals



3RA6823-0AC

1

1 unit

42F

Load Feeders and Motor Starters for Use in the Control Cabinet

SIRIUS 3RA6 Compact Starters

Infeed system for 3RA6

Version	SD	Article No.	Price per PU	PU (UNIT, SET, M)	PS*	PG
	d					

Accessories for infeed systems for 3RA6

PE infeeds, 25/35 mm²



3RA6860-6AB

- Version with screw terminals

2

Screw terminals



3RA6860-6AB

1

1 unit

42F



3RA6860-5AC

- Version with spring-loaded terminals

2

Spring-loaded terminals



3RA6860-5AC

1

1 unit

42F

PE pick-offs 6/10 mm²



3RA6870-4AB

- Version with screw terminals

2

Screw terminals



3RA6870-4AB

1

1 unit

42F



3RA6870-3AC

- Version with spring-loaded terminals

2

Spring-loaded terminals



3RA6870-3AC

1

1 unit

42F

Expansion plugs

PE expansion plugs



3RA6890-0EA

2

3RA6890-0EA

1

1 unit

42F

Expansion plugs

Between 2 expansion modules
Included in the scope of supply of the expansion modules



3RA6890-1AB

2

3RA6890-1AB

1

1 unit

42F

Expansion plugs for SIRIUS 3RV29 infeed system

Connects infeed system for 3RA6 to 3RV29 infeed system



3RA6890-1AA

2

3RA6890-1AA

1









1 unit

42F

Load Feeders and Motor Starters for Use in the Control Cabinet

SIRIUS 3RA6 Compact Starters

Infeed system for 3RA6

Version	SD	Article No.	Price per PU	PU (UNIT, SET, M)	PS*	PG
Accessories for infeed systems for 3RA6 (continued)						
 3RA6890-0BA	45 mm adapters For SIRIUS 3RV1.2 and 3RV2.2 motor starter protectors/ circuit breakers size S0 up to 25 A <ul style="list-style-type: none"> Screw terminals (conductor cross-section AWG 10) 	Screw terminals 		1	1 unit	42F
		2	3RA6890-0BA			
 3RA6880-2AB	Terminal covers for infeeds with screw terminal IP20 terminal covers for infeeds with screw terminal 25/35 mm² (3RA6812-8AB/AC) (2 units per pack)	Terminal covers for infeeds with screw terminal		1	1 unit	42F
		2	3RA6880-2AB			
 3RA6880-3AB	IP20 terminal covers for infeeds with screw terminal 50/70 mm² (3RA6813-8AB/AC) (2 units per pack)	Terminal covers for infeeds with screw terminal		1	1 unit	42F
		2	3RA6880-3AB			
 3RV2917-5D	Terminal blocks For integration of single-phase, two-phase and three-phase external components <ul style="list-style-type: none"> Spring-loaded terminals 	Spring-loaded terminals 		1	1 unit	41E
		2	3RV2917-5D			
Tools for opening spring-loaded terminals						
 3RA2908-1A	Screwdrivers For all SIRIUS devices with spring-loaded terminals Length approx. 200 mm, 3.0 mm x 0.5 mm, titanium gray/black, partially insulated	Spring-loaded terminals 		1	1 unit	41B
		2	3RA2908-1A			
System Manual						
System Manual "SIRIUS 3RA6 Compact Starter, SIRIUS Infeed System for 3RA6", see https://support.industry.siemens.com/cs/ww/en/view/27865747						

Overview



3RM13 motor starter with reversing functionality, electronic overload protection and safety-related shutdown

More information

3RM1 motor starters:

- Homepage, see www.siemens.com/motorstarter/3RM1
- Industry Mall, see www.siemens.com/product?3RM1

3SK safety relays for protecting the 3RM1 motor starters:

- Homepage, see www.siemens.com/safety-relays
- Industry Mall, see www.siemens.com/product?3SK

TIA Selection Tool Cloud (TST Cloud), see

<https://www.siemens.com/tstcloud/?node=MotorStarter3RM1>

SIRIUS 3RM1 motor starters are compact devices, 22.5 mm wide, combining a large number of functions in a single enclosure. They consist of combinations of relay contacts, power semiconductors (hybrid technology), and an electronic overload relay for operational switching of three-phase motors up to 3 kW (at 400 V) and resistive loads up to 10 A at AC voltages up to 500 V.

The 3RM1 motor starters with overload protection with wide setting range are available as direct-on-line starters and reversing starters and as versions with safety-related shutdown up to SIL 3/PL e.

Seamlessly integrated safety right through to the main circuit

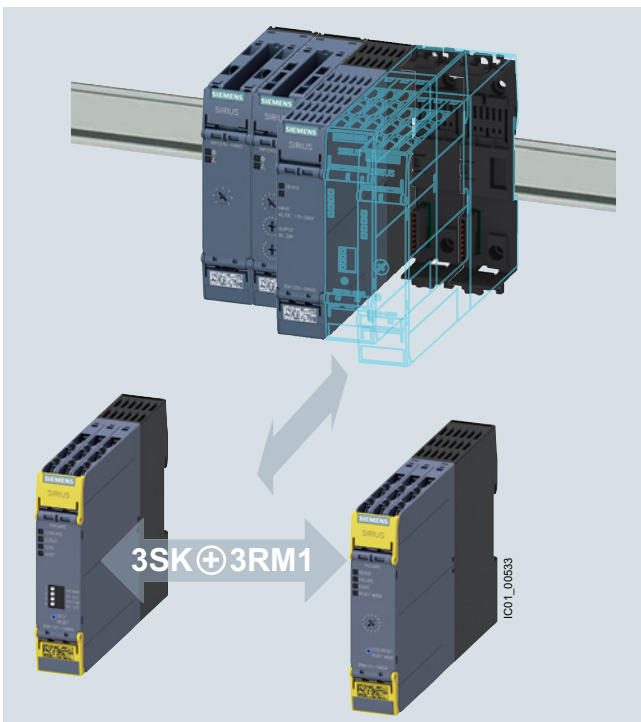

Problem-free integration of functional safety into the main circuit through the simple combination of 3RM1 and 3SK devices

Functional safety in the main circuit needs to be both simple and flexible.

The unique compatibility of hybrid 3RM1 fail-safe motor starters and 3SK safety relays means that integrated functional safety right through to the main circuit is no longer a problem.

Their compact design allows the motor starters to be installed to the right of the safety relay in a simple manner, just like an output expansion. The wiring of the safety-related signals to the relay can be performed simply, quickly and in an error-free manner using the device connector.

The ergonomically designed enclosure with removable terminals and terminal labeling in the hinged cover allows for the cables to be conveniently diagonally mounted from the front. Either screw or spring-loaded terminals with push-in technology are available.

Highlights

- Fail-safe disconnection of motors up to 3 kW
- Problem-free combination of fail-safe motor starters and safety relays
- End-to-end system, simple setup using device connectors
- Ergonomic enclosure

Note:

For SIRIUS 3SK safety relays, see page 11/12.

Load Feeders and Motor Starters for Use in the Control Cabinet

SIRIUS 3RM1 motor starters

Article No. scheme

Product versions		Article number				
Product function	Direct-on-line starters	3RM10	0	<input type="checkbox"/> - <input type="checkbox"/> AA	<input type="checkbox"/> 4	
	Failsafe direct-on-line starters	3RM11	0	<input type="checkbox"/> - <input type="checkbox"/> AA	<input type="checkbox"/> 4	with ATEX certification and safety-related shutdown
	Reversing starters	3RM12	0	<input type="checkbox"/> - <input type="checkbox"/> AA	<input type="checkbox"/> 4	
	Failsafe reversing starters	3RM13	0	<input type="checkbox"/> - <input type="checkbox"/> AA	<input type="checkbox"/> 4	with ATEX certification and safety-related shutdown
Wide setting range for electronic overload release	0.1 ... 0.5 A		1			For motor standard output 0 ... 0.12 kW ²⁾
	0.4 ... 2.0 A		2			For motor standard output 0.09 ... 0.75 kW ²⁾
	1.6 ... 7.0 A (10 A) ¹⁾		7			For motor standard output 0.55 ... 3 kW ²⁾
Connection method	Screw terminals		1			
	Spring-loaded terminals (push-in)		2			
	Mixed connection method		3			Spring-loaded terminals (push-in)
Rated control supply voltage U_s	24 V DC				0	
	110 ... 230 V AC; 110 V DC				1	
Example		3RM13	0	1 - 2	AA	0 4

¹⁾ Operation of resistive loads up to 10 A.

²⁾ Standard three-phase motor, basis 4-pole at 400 V AC; the actual startup characteristics of the motor as well as its rated data are important factors here.

Note:

The article number scheme shows an overview of product versions for better understanding of the logic behind the article numbers.

For your orders, please use the article numbers quoted in the selection and ordering data.

Benefits

Product advantages

- Less space required in the control cabinet (20 to 80%) thanks to high functional density, which also means reduced wiring and testing
- Greater endurance and reduced heat losses thanks to hybrid technology
- Lower costs for stock keeping and configuration as a result of the wide setting range of the electronic overload release (up to 1:5)
- Fast wiring without tools for rigid conductors or conductors equipped with end sleeves thanks to spring-loaded terminals (push-in)
- Safety-related shutdown in accordance with SIL 3/PL e by shutting down the control supply voltage without additional devices in the main circuit
- The motor starters can be ideally combined with 3SK safety relays for safety-related shutdown (see page 11/12)
- Motor status feedback to the higher-level control system in the case of 3RM10 and 3RM12 motor starters in the 24 V DC version
- Virtually error-free wiring on the mains connection side and reduction in short-circuit protective devices by means of 3RM19 infeed system
- ATEX certification of the overload protection of the 3RM1 Failsafe motor starters: "Increased safety" type of protection EEx e according to ATEX directive 2014/34/EU
- The 3RM1 motor starters can be used with highly energy-efficient IE3/IE4 motors. In this regard, please observe the information on dimensioning and configuring, see [Application Manual](#).
For more information about IE3/IE4, see page 1/7.

Standards and approvals

- IEC/EN 60947-4-2
- UL 60947-4-2
- CSA
- ATEX
- IEC 61508-1: SIL 3
- ISO 13849: PL e
- CCC approval for China

Load Feeders and Motor Starters for Use in the Control Cabinet

SIRIUS 3RM1 motor starters

Technical specifications

More information

Industry Mall, see www.siemens.com/product?3RM1FAQs, see <https://support.industry.siemens.com/cs/ww/en/ps/16311/faq>Equipment Manual, see <https://support.industry.siemens.com/cs/ww/en/view/66295730>

Article number		3RM10, 3RM12	3RM11, 3RM13
General technical specifications:			
Dimensions (W x H x D)	mm	22.5 x 100 x 141.6	
Ambient temperature			
• During operation	°C	-25 ... +60	
• During storage	°C	-40 ... +70	
• During transport	°C	-40 ... +70	
Installation altitude at height above sea level, maximum	m	4 000	2 000
Shock resistance		6 g / 11 ms	
Vibration resistance		1 ... 6 Hz, 15 mm; 20 m/s ² , 500 Hz	
Degree of protection		IP20	
Mounting position		Vertical, horizontal, standing (consider derating)	

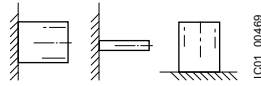





Article number		3RM1.01	3RM1.02	3RM1.07
Main circuit:				
Operational voltage, rated value, maximum	V	500		
Operating frequency	Hz	50/60		
Operational current at AC-53a at 400 V at an ambient temperature of 40 °C	A	0.5	2	7
Minimum load [% of IM]	%	20		
Adjustable current response value of the inverse-time delayed overload release	A	0.1 ... 0.5	0.4 ... 2	1.6 ... 7

Article number		3RM1.0.-AA04	3RM1.0.-AA14
Control circuit:			
Type of voltage of the control supply voltage		DC	AC/DC
Control supply voltage			
• At DC	V	24	110
• At AC at 50 Hz	V	--	110 ... 230
Frequency of the control supply voltage	Hz	--	50/60

Load Feeders and Motor Starters for Use in the Control Cabinet

SIRIUS 3RM1 motor starters

Type		3RM1.0.-1AA.4	3RM1.0.-3AA.4	3RM1.0.-2AA.4
Connections/terminals:				
Type of electrical connection for main circuit (1 or 2 conductors can be connected)		 Screw terminals	 Spring-loaded terminals (push-in)	
Connectable conductor cross-section for main contacts				
• Solid	mm ²	1 x (0.5 ... 4), 2 x (0.5 ... 2.5)		1 x (0.5 ... 4)
• Finely stranded	mm ²	1 x (0.5 ... 4), 2 x (0.5 ... 1.5)		1 x (0.5 ... 2.5)
- With end sleeve	mm ²	--		1 x (0.5 ... 4)
- Without end sleeve	mm ²	--		1 x (0.5 ... 4)
Type of electrical connection for auxiliary and control circuit (1 or 2 conductors can be connected)		 Screw terminals	 Spring-loaded terminals (push-in)	
Type of connectable conductor cross-sections for auxiliary contacts				
• Solid	mm ²	1 x (0.5 ... 2.5), 2 x (1.0 ... 1.5)	1 x (0.5 ... 1.5), 2 x (0.5 ... 1.5)	
• Finely stranded	mm ²	1 x (0.5 ... 2.5), 2 x (0.5 ... 1)	1 x (0.5 ... 1.0), 2 x (0.5 ... 1.0)	
- With end sleeve	mm ²	--	1 x (0.5 ... 1.5), 2 x (0.5 ... 1.5)	
- Without end sleeve	mm ²	--	1 x (0.5 ... 1.5), 2 x (0.5 ... 1.5)	
Type of connectable conductor cross-sections for AWG cables				
• For main contacts		1 x (20 ... 12), 2 x (20 ... 14)		1 x (20 ... 12)
• For auxiliary contacts		1 x (20 ... 14), 2 x (18 ... 16)	1 x (20 ... 16), 2 x (20 ... 16)	

Accessories

More information

Equipment Manual, see
<https://support.industry.siemens.com/cs/ww/en/view/66295730>

Three-phase infeed system (3RM19 three-phase busbar system)

The system permits an easy, time-saving and safe means of feeding two or more 3RM1 motor starters. It can be used only with motor starters with screw terminals and in combination with 8US1716-ORK00 adapters for mounting rails in the main circuit.

The maximum summation current must not exceed 25 A. The primary infeed is connected via a three-phase infeed terminal.

The busbars are available in three lengths, for two, three or five motor starters. More than five devices can be connected by clamping the connection tags of a second busbar rotated by 180°.

The three-phase busbars are finger-safe but empty connection tags must be fitted with covers.

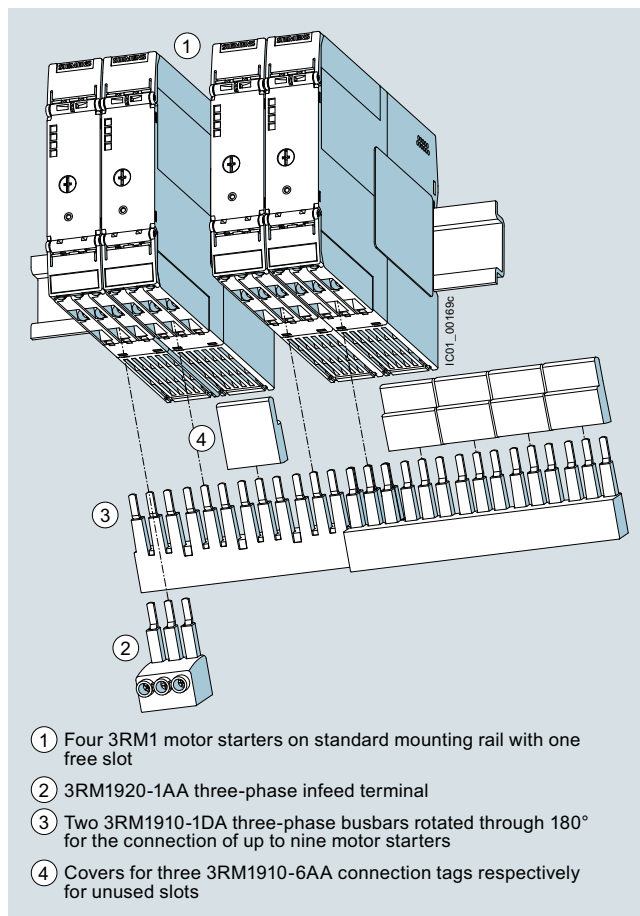

3RM19 infeed system with three-phase infeed terminal: In the above example, two three-phase busbars (5-pole busbars) rotated through 180° allow up to nine 3RM1 motor starters to be connected. Contact with the unused connection tags in unoccupied positions is prevented safely by the covers.

Fuse module for the use of 3RM1 motor starters on 8US busbar systems and mounting rails

The fuse module permits the very compact construction of a load feeder with a maximum width of 22.5 mm. The 3RM1 motor starter in combination with the integrated fuses for short-circuit protection can therefore be used on 8US busbar systems. Thanks to the range of different adapters, the fuse module can be used in all 60 mm busbar systems and also in compact busbar systems and on mounting rails. The interface to the adapter also permits a simple and secure replacement of the load feeder.

The fuse module can be combined with all 3RM1 motor starters. The easily replaceable fuses protect the connected motor and the cables.

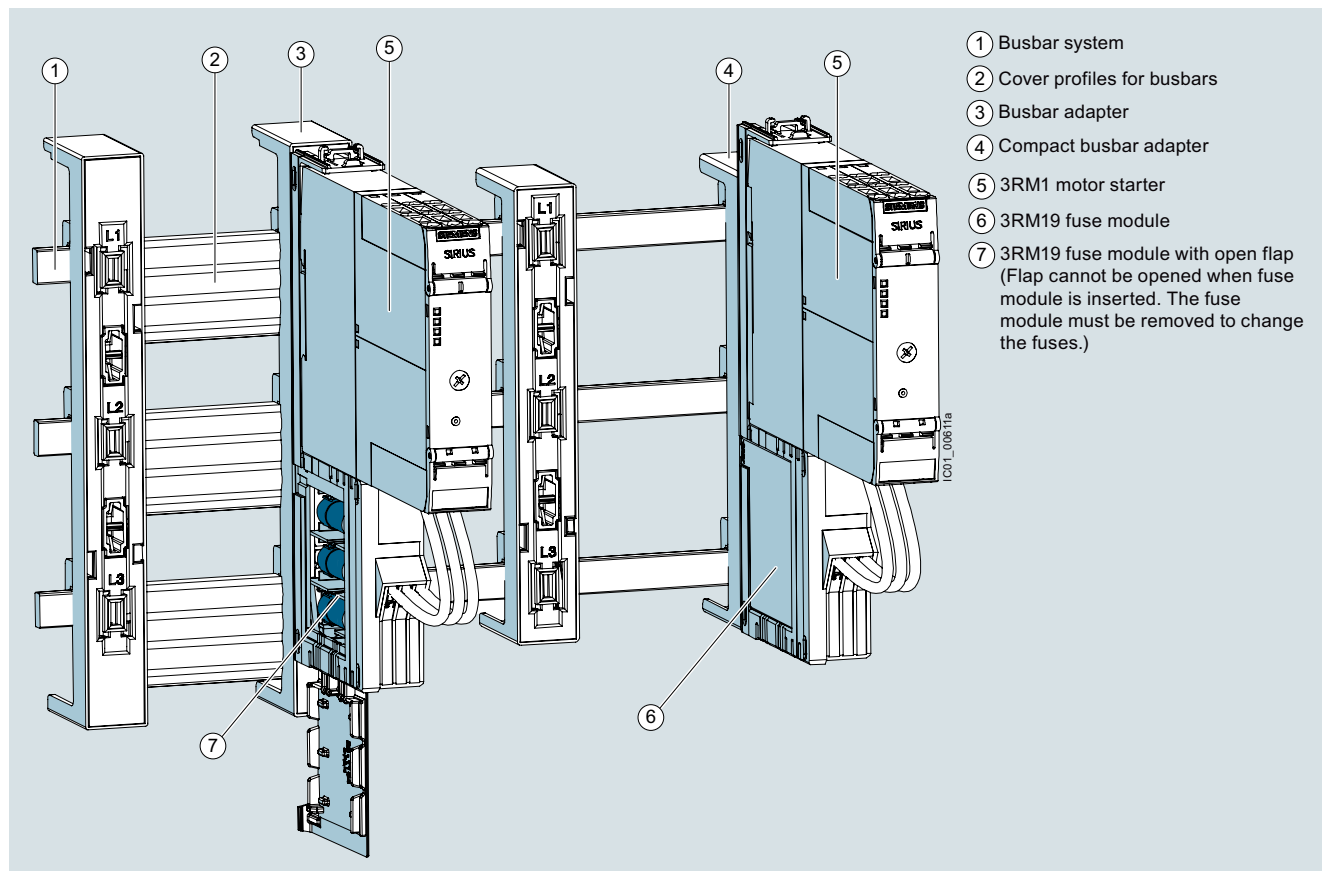

By means of the fuse module, 3RM1 motor starters can be used in busbar systems and 8US compact busbar systems, as well as on mounting rails

Load Feeders and Motor Starters for Use in the Control Cabinet

SIRIUS 3RM1 motor starters

Device connectors for the control circuit

The device connectors for 3RM1 motor starters (24 V DC control supply voltage only) reduce the outlay for cabling by looping through the control supply voltage. The device connectors can be snapped onto a standard mounting rail or fixed to a level mounting panel using screws.

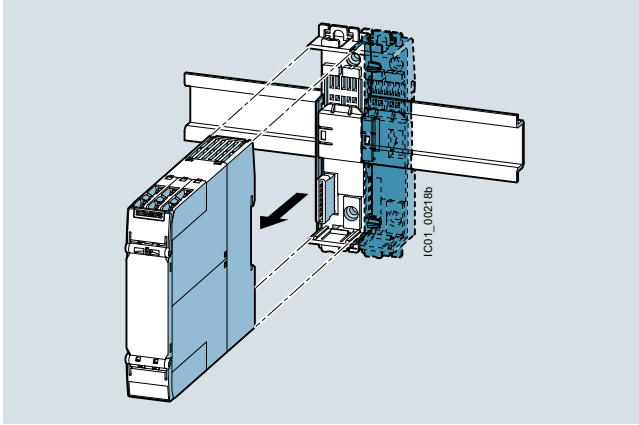

Device connector with 3RM1 motor starter

Using the device connectors exclusively for feeding in the control supply voltage

By using device connectors, a maximum of five motor starters can be supplied with 24 V DC control supply voltage. This requires the control supply voltage to be applied to the A1 and A2 terminals of only one motor starter.

Device daisy chain connectors can be used for gaps between two motor starters. Device termination connectors terminate a group.

Using the device connectors for safe group shutdown

In combination with the 3RM11 and 3RM13 fail-safe motor starters, the device connector can also be used for safety-related shutdown. For this application, groups of no more than five fail-safe motor starters can be connected using a device connector, and the group must be terminated with a termination connector. Removing the control voltage supply from the first motor starter will safely shut down the whole group.

Safe group shutdown can be implemented particularly easily in conjunction with 3SK safety relays. In this case, up to five motor starters can be directly connected to 3SK safety relays via the device connector and then safely shut down (see page 11/12).

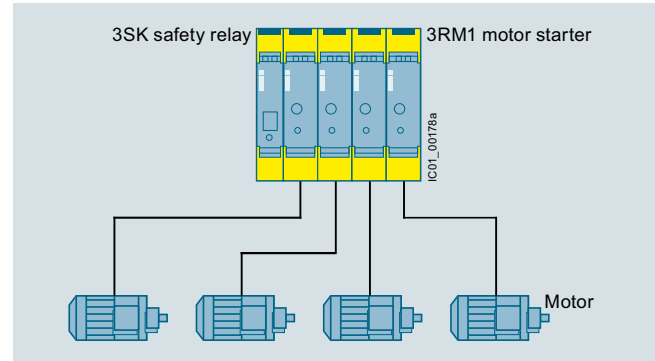

Ideal connection: Combination of four SIRIUS 3RM1 Failsafe motor starters with SIRIUS 3SK safety relays

Electromechanical switching devices in series with hybrid motor starters

Switching an inductive load - in particular of motors < 1 kW with high inductance - with an electromechanical switching device (e.g. contactor) can cause high and steep voltage edges.

The resulting faults/damage can be prevented by first disconnecting with the hybrid motor starter or by using EMC suppression modules:

- For 3RT2916-1P. EMC suppression modules for direct mounting on the contactor, see page 3/118
- For motor suppression modules that are fitted in the main circuit, see page 8/94

Note:

For more information, see <https://support.industry.siemens.com/cs/ww/en/view/109758696>.





Load Feeders and Motor Starters for Use in the Control Cabinet

IE3/IE4 ready SIRIUS 3RM1 motor starters

Selection and ordering data

More information

Industry Mall, see www.siemens.com/product?3RM1

	Operational power for three-phase motor at 400 V ¹⁾	Adjustable current response value of the inverse-time delayed overload release	Control supply voltage		SD	Article No.	Price per PU	PU (UNIT, SET, M)	PS*	PG
			At DC	At AC at 50 Hz						
	kW	A	V	V	d					
Direct-on-line starters										
	0 ... 0.12	0.1 ... 0.5	24	--	2	3RM1001-□AA04		1	1 unit	41D
	0.09 ... 0.75	0.4 ... 2	24	--	2	3RM1002-□AA04		1	1 unit	41D
	0.55 ... 3	1.6 ... 7	24	--	2	3RM1007-□AA04		1	1 unit	41D
	0 ... 0.12	0.1 ... 0.5	110	110 ... 230	2	3RM1001-□AA14		1	1 unit	41D
	0.09 ... 0.75	0.4 ... 2	110	110 ... 230	2	3RM1002-□AA14		1	1 unit	41D
	0.55 ... 3	1.6 ... 7	110	110 ... 230	2	3RM1007-□AA14		1	1 unit	41D
Reversing starters										
	0 ... 0.12	0.1 ... 0.5	24	--	2	3RM1201-□AA04		1	1 unit	41D
	0.09 ... 0.75	0.4 ... 2	24	--	2	3RM1202-□AA04		1	1 unit	41D
	0.55 ... 3	1.6 ... 7	24	--	2	3RM1207-□AA04		1	1 unit	41D
	0 ... 0.12	0.1 ... 0.5	110	110 ... 230	2	3RM1201-□AA14		1	1 unit	41D
	0.09 ... 0.75	0.4 ... 2	110	110 ... 230	2	3RM1202-□AA14		1	1 unit	41D
	0.55 ... 3	1.6 ... 7	110	110 ... 230	2	3RM1207-□AA14		1	1 unit	41D
Failsafe direct-on-line starters										
	0 ... 0.12	0.1 ... 0.5	24	--	2	3RM1101-□AA04		1	1 unit	41D
	0.09 ... 0.75	0.4 ... 2	24	--	2	3RM1102-□AA04		1	1 unit	41D
	0.55 ... 3	1.6 ... 7	24	--	2	3RM1107-□AA04		1	1 unit	41D
	0 ... 0.12	0.1 ... 0.5	110	110 ... 230	2	3RM1101-□AA14		1	1 unit	41D
	0.09 ... 0.75	0.4 ... 2	110	110 ... 230	2	3RM1102-□AA14		1	1 unit	41D
	0.55 ... 3	1.6 ... 7	110	110 ... 230	2	3RM1107-□AA14		1	1 unit	41D
Failsafe reversing starters										
	0 ... 0.12	0.1 ... 0.5	24	--	2	3RM1301-□AA04		1	1 unit	41D
	0.09 ... 0.75	0.4 ... 2	24	--	2	3RM1302-□AA04		1	1 unit	41D
	0.55 ... 3	1.6 ... 7	24	--	2	3RM1307-□AA04		1	1 unit	41D
	0 ... 0.12	0.1 ... 0.5	110	110 ... 230	2	3RM1301-□AA14		1	1 unit	41D
	0.09 ... 0.75	0.4 ... 2	110	110 ... 230	2	3RM1302-□AA14		1	1 unit	41D
	0.55 ... 3	1.6 ... 7	110	110 ... 230	2	3RM1307-□AA14		1	1 unit	41D

3RM1001-1AA04

3RM1201-1AA04

3RM1101-1AA04

3RM1301-1AA04

Type of electrical connection

- Screw terminals for main circuit, screw terminals for control circuit
- Spring-loaded terminals (push-in) for main circuit, spring-loaded terminals (push-in) for control circuit
- Screw terminals for main circuit, spring-loaded terminals (push-in) for control circuit

¹⁾ The actual startup characteristics of the motor as well as its rated data are important factors here.

1
2
3

Load Feeders and Motor Starters for Use in the Control Cabinet







SIRIUS 3RM1 motor starters

Product designation	SD	Article No.	Price per PU	PU (UNIT, SET, M)	PS*	PG
Three-phase infeed system for 3RM1 with screw terminals						
 3RM1920-1AA		Three-phase infeed terminals ▶ 3RM1920-1AA • For three-phase busbars		1	1 unit	41D
 3RM1910-1AA		Three-phase busbars ▶ 3RM1910-1AA • For 2 motor starters		1	1 unit	41D
 3RM1910-1BA		• For 3 motor starters ▶ 3RM1910-1BA		1	1 unit	41D
 3RM1910-1DA		• For 5 motor starters ▶ 3RM1910-1DA		1	1 unit	41D
 3RM1910-6AA		Covers ▶ 3RM1910-6AA For 3 connection tags of the three-phase busbars		1	10 units	41D
Fuse modules for 3RM1 for use on busbars or mounting rails						
 3RM1932-1AB		Fuse module with 3NW6007-1 fuse ▶ 3RM1932-1AB	2	1	1 unit	41D
		Fuse module without fuse¹⁾ ▶ 3RM1930-1AA	10	1	1 unit	41D
Adapters						
 8US1216-0AS00		Adapters for 60 mm busbar systems ▶ 8US1216-0AS00 22.5 mm x 200 mm x 41.5 mm Note: The adapter can be used on busbars with a width of 12 mm and a thickness of 5 mm or 10 mm.	5	1	1 unit	140
 8US1616-0AK02		Adapters for 60 mm compact busbar systems ▶ 8US1616-0AK02 22.5 mm x 160 mm x 41.5 mm Note: The adapter can be used on busbars with a width of 12 mm, 15 mm, 20 mm, 25 mm or 30 mm and a thickness of 5 mm or 10 mm.	5	1	1 unit	140

1) For details of alternative fuses, see [Equipment Manual](#).

Load Feeders and Motor Starters for Use in the Control Cabinet

SIRIUS 3RM1 motor starters

Product designation	SD	Article No.	Price per PU	PU (UNIT, SET, M)	PS*	PG
d						
Adapters						
 8US1716-0RK00	Adapter for 35 mm DIN mounting rails 22.5 mm x 185 mm x 23.5 mm	5	8US1716-0RK00	1	1 unit	140
Cover profiles¹⁾²⁾						
Cover profiles for busbars						
 8US1922-2CA00	12 mm x 5 mm x 1 000 mm 40 mm or 60 mm center-to-center busbar clearance depending on busbar system	2	8US1922-2CA00	1	10 units	140
 8US1922-2AA00	15 mm x 5 mm x 1 000 mm 20 mm x 5 mm x 1 000 mm 25 mm x 5 mm x 1 000 mm 30 mm x 5 mm x 1 000 mm 40 mm or 60 mm center-to-center busbar clearance depending on busbar system	2	8US1922-2AA00	1	10 units	140
 8US1922-2BA00	12 mm x 10 mm x 1 000 mm 15 mm x 10 mm x 1 000 mm 20 mm x 10 mm x 1 000 mm 25 mm x 10 mm x 1 000 mm 30 mm x 10 mm x 1 000 mm 60 mm center-to-center busbar clearance	2	8US1922-2BA00	1	10 units	140
Device connectors						
 3ZY1212-2EA00	Device connectors For 3RM1 motor starters, 24 V DC, 22.5 mm	2	3ZY1212-2EA00	1	1 unit	41L
 3ZY1212-2AB00	Device daisy chain connectors For 3RM1 motor starters 24 V DC, 22.5 mm For gaps without motor starters in assemblies	2	3ZY1212-2AB00	1	1 unit	41L
 3ZY1212-2FA00	Device termination connectors For 3RM1 motor starters, 24 V DC, 22.5 mm	2	3ZY1212-2FA00	1	1 unit	41L

1) The cover profiles for busbars can be used for maintaining minimum spacing between the load feeders.

2) For further accessories for the configuration of a busbar system, see [Catalog LV 10](#).

Load Feeders and Motor Starters for Use in the Control Cabinet

SIRIUS 3RM1 motor starters

Product designation	SD	Article No.	Price per PU	PU (UNIT, SET, M)	PS*	PG	
Removable terminals							
 3ZY1122-1BA00	Terminal for main circuit, 2-pole						
	• Screw terminals, 1 x 4 mm ²	2	Screw terminals 				
			3ZY1122-1BA00	1	6 units	41L	
	• Spring-loaded terminals (push-in), 1 x 4 mm ²	2	Spring-loaded terminals (push-in) 				
		3ZY1122-2BA00	1	6 units	41L		
 3ZY1131-1BA00	Terminal for control circuit, 3-pole						
	• Screw terminals, 1 x 2.5 mm ²	2	Screw terminals 				
			3ZY1131-1BA00	1	6 units	41L	
	• Spring-loaded terminals (push-in), 1 x 2.5 mm ²	2	Spring-loaded terminals (push-in) 				
		3ZY1131-2BA00	1	6 units	41L		
Further accessories							
 3ZY1311-0AA00	Push-in lugs for wall mounting 2 lugs per device are required		2	3ZY1311-0AA00	1	10 units	41L
 3ZY1321-2AA00	Sealable covers, 22.5 mm For simple protection against unauthorized access		2	3ZY1321-2AA00	1	5 units	41L
 3ZY1440-1AA00	Coding pins for removable terminals For mechanical coding of the terminals		2	3ZY1440-1AA00	1	12 units	41L
 3ZY1450-1AB00	Hinged cover Replacement cover, without terminal labeling, 22.5 mm wide						
	• Titanium gray	2	3ZY1450-1AB00	1	5 units	41L	
	• Yellow	2	3ZY1450-1BB00	1	5 units	41L	
 3RK1911-6EA00	Motor suppression module						
	• Square	15	3RK1911-6EA00	1	1 unit	42D	
	• Round	15	3RK1911-6EB00	1	1 unit	42D	
 3RA2908-1A	Screwdrivers For all SIRIUS devices with spring-loaded terminals Length approx. 200 mm, 3.0 mm x 0.5 mm, titanium gray/black, partially insulated		2	Spring-loaded terminals 			
				3RA2908-1A	1	1 unit	41B

Overview

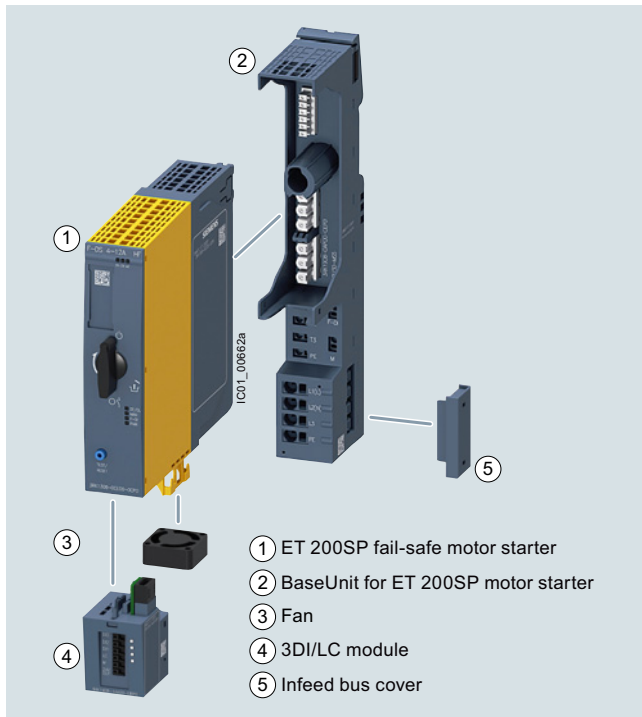

Motor starter, BaseUnit, fan and 3DI/LC control module

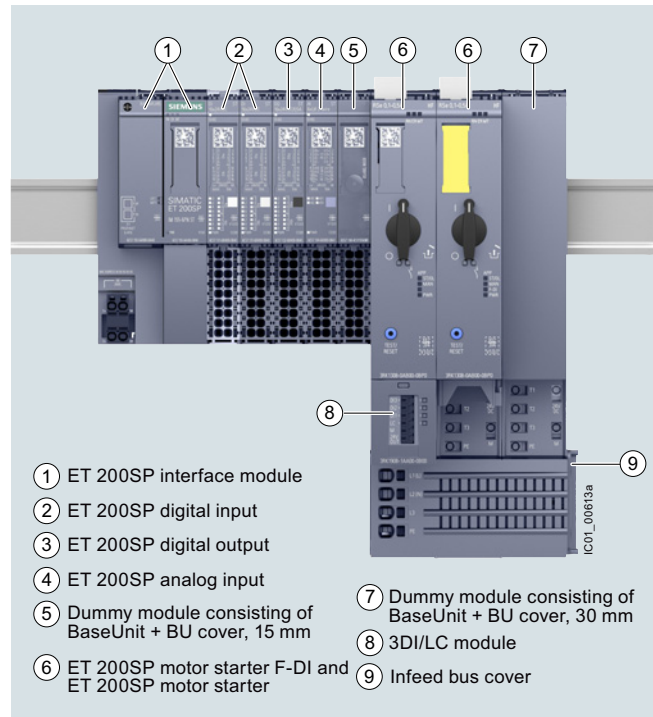

3RK1308 motor starter in the ET 200SP I/O system

More information

Homepage, see www.siemens.com/ET200SP-motorstarter
Industry Mall, see www.siemens.com/product?3RK1308
TIA Selection Tool, see www.siemens.com/TST

Further components in the ET 200SP I/O system:

- [Catalog ST 70](#)
- Industry Mall, see www.siemens.de/product?ET200SP

ET 200SP motor starters

ET 200SP is a scalable and extremely flexible modular I/O system with IP20 degree of protection.

As I/O modules, the ET 200SP motor starters are an integral part of this I/O system. They are switching and protection devices for single- and three-phase loads and are available as direct-on-line or reversing starters.

Basic functionality

All versions of the ET 200SP motor starter feature the following functionality:

- Fully pre-wired motor starters for switching and protecting any AC loads up to 5.5 kW from 48 V AC to 500 V AC
- Disconnection possible via fail-safe motor starters up to SIL 3 and PL e Cat. 4
- With self-assembling 32 A power bus, i.e. the load voltage is only fed in once for a group of motor starters
- All control supply voltages connected only once, i.e. when modules are added they are automatically connected to the next module
- Hot swapping is permissible
- Digital inputs can optionally be used via a 3DI/LC module
- Control of the motor starter from the control system and extensive diagnostics status via the cyclic process image
- Diagnostics capability for active monitoring of the switching and protection functions

- The signal states in the process image of the motor starter provide information about protective devices (short circuit or overload), the switching states of the motor starter, and system faults.

Starter Kit

The 3RK1908-1SK00 Starter Kit is a favorably priced complete package for switching and monitoring motors in the ET 200SP system, see [page 8/104](#).

It contains:

- a 3RK1308-0BC00-0CP0 reversing starter (0.9 to 3 A)
- a 3RK1908-0AP00-0AP0 BaseUnit with 500 V and 24 V AC/DC infeed
- an EMC distance module (consisting of 6ES7193-6BP00-0BA0 BaseUnit plus 6ES7133-6CV15-1AM0 BU cover 15 mm)

Use of fan

For motor starters with a 12 A rated current, the 3RW4928-8VB00 fan is included in the scope of supply.

This fan can also be ordered as an option for motor starters with lower rated currents, if the boundary conditions demand this. For information on the ambient conditions for the use of motor starters, see [chapter "Product overview" in the Equipment Manual](#).

Load Feeders and Motor Starters for Use in the Control Cabinet

ET 200SP motor starters

Designing interference-free motor starters

For interference-free operation of the ET 200SP station in accordance with IEC 60947-4-2 standard, use a dummy module before the first motor starter. The dummy module consists of the 6ES7193-6BP00-0BA0 or 6ES7193-6BP00-0DA0 BaseUnit and the 6ES7133-6CV15-1AM0 BU cover 15 mm.

The 15 mm BU cover protects the plug contacts of the BaseUnit against dirt.

Electromechanical switching devices in series with hybrid motor starters

Switching an inductive load - in particular of motors <1 kW with high inductance - with an electromechanical switching device (e.g. contactor) can cause high and steep voltage edges.

The resulting faults/damage can be prevented by first disconnecting with the hybrid motor starter or by using EMC suppression modules:

- For 3RT2916-1P.. EMC suppression modules for direct mounting on the contactor, [see page 3/118](#)
- For motor suppression modules that are fitted in the main circuit, [see page 8/104](#)

Note:

For more information, [see https://support.industry.siemens.com/cs/ww/en/view/109758696](https://support.industry.siemens.com/cs/ww/en/view/109758696).

3DI/LC control module

This is a digital input module with three inputs for local motor starter functions such as "manual local control", "implementation of fast inputs" or "end position disconnection". For a list of all the functions permitted by the 3DI/LC module, [see chapter "Overview of functions" in the Equipment Manual](#).

The module is plugged into the front of the motor starter from which it is supplied with a 24 V DC operating voltage.

BaseUnits for motor starters

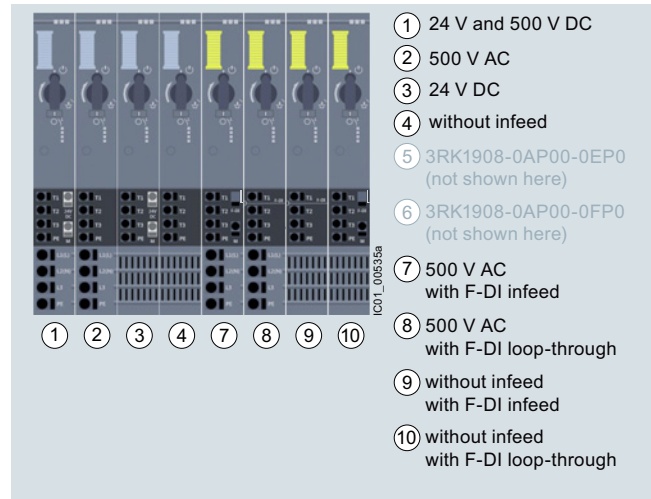

View of the BaseUnit infeeds for the motor starters

BaseUnits are components for accommodating the ET 200SP I/O modules.

The self-assembling voltage buses integrated into the BaseUnits reduce wiring outlay to the single infeed (both of auxiliary and load voltage).

All modules following on the right are automatically supplied upon plugging the BaseUnits together, if BaseUnits are inserted with routing.

The rugged design and keyed connection technology enables use in harsh industrial conditions.

The BaseUnits are available with various infeeds for the motor starters.

Article No. scheme

Product versions		Article number	
Motor starters		3RK1308 - 0 <input type="checkbox"/> <input type="checkbox"/> 0 0 - 0 C P 0	
Product function	Direct-on-line starters	A	For motor standard output 0.09 ... 5.5 kW ¹⁾
	Reversing starters	B	For motor standard output 0.09 ... 5.5 kW ¹⁾
	Fail-safe direct-on-line starters	C	For motor standard output 0.09 ... 5.5 kW ¹⁾
	Fail-safe reversing starters	D	For motor standard output 0.09 ... 5.5 kW ¹⁾
Current range	0.1 ... 0.4 A	A	Maximum current-carrying capacity when starting 4 A
	0.3 ... 1 A	B	Maximum current-carrying capacity when starting 10 A
	0.9 ... 3 A	C	Maximum current-carrying capacity when starting 30 A
	2.8 ... 9 A	D	Maximum current-carrying capacity when starting 90 A
	4 ... 12 A	E	Including fan (3RW4928-8VB00), maximum current-carrying capacity when starting 100 A
Example		3RK1308 - 0 A D 0 0 - 0 C P 0	

¹⁾ For standard motors: Single- or three-phase asynchronous motors, single-phase AC motors, single-phase asynchronous motors, at 400 V AC and 500 V AC; the actual startup characteristics of the motor as well as its rated data are important factors here.

Product versions		Article number	
BaseUnit		3RK1908 - 0 A P 0 0 - 0 <input type="checkbox"/> P 0	
BU infeed	24 V and 500 V AC	A	
	24 V DC	B	
	500 V AC	C	
	without infeed	D	
	500 V AC	G	with F-DI infeed
	500 V AC	H	with F-DI loop-through
	without infeed	J	with F-DI loop-through
	without infeed	K	with F-DI infeed
Example		3RK1908 - 0 A P 0 0 - 0 A P 0	

Note:

The article number schemes show an overview of product versions for better understanding of the logic behind the article numbers.

For your orders, please use the article numbers quoted in the selection and ordering data.

Benefits

Product advantages

The ET 200SP motor starters offer a number of advantages:

- Fully integrated into the ET 200SP I/O system (including TIA Selection Tool and TIA Portal)
- High degree of flexibility when it comes to safety applications via SIMATIC F-CPU or SIRIUS 3SK safety relays up to SIL 3 and PL e Cat. 4.
- Simple, integrated current value transmission
- Extensive parameterization by means of TIA Portal
- Increase of plant availability through fast replacement of units (easy mounting and plug-in technology)
- Greater endurance and reduced heat losses thanks to hybrid technology
- Less space required in the control cabinet (20 to 80%) as a result of greater functional density (direct-on-line and reversing starters in same width)
- Extensive diagnostics and information for preventive maintenance
- Parameterizable inputs via 3DI/LC control module
- Less wiring and testing required as a result of integrating several functions into a single device
- Lower overheads for stock keeping and configuration as a result of the wide setting range of the electronic overload release (up to 1:3)
- Technology has lower inherent power losses than speed-controlled drive systems, so that less cooling (and smaller footprint) are possible

- The ET 200SP motor starters can be used with highly energy-efficient IE3/IE4 motors, [see Application Manual](#). Take the current characteristics of the connected motor and motor starter into account when dimensioning. In addition to the rated current, the maximum permissible current range of the motor starter and the ratio of the rated current to the starting current of the motor are relevant. For more information on IE3/IE4, [see page 1/7](#).

Standards and approvals

- IEC/EN 60947-4-2
- UL 60947-4-2
- CSA
- ATEX
- IEC 61508-1: SIL 3
- ISO 13849: PL e
- CCC approval for China

Load Feeders and Motor Starters for Use in the Control Cabinet

ET 200SP motor starters

Application

The ET 200SP motor starters are suitable for the following applications:

- Switching and monitoring of
 - three-phase motors with overload and short-circuit protection (e.g. 400 V asynchronous motors for secondary drives in conveyor systems)
 - single-phase motors with overload and short-circuit protection (e.g. 230 V motors for pump applications)
 - Resistive loads by means of current value and diagnostics via the maintenance function (e.g. for heaters)
- Plant monitoring and energy management in conveyor systems:
 - By means of the phase asymmetry and zero current detection during current measurement, for example, drive belt monitoring and blocking monitoring are possible.

- Track switching and lifting table control in conveyor systems: Track switches can be implemented using the quick stop function and lifting table controls by means of the "immediate end position disconnection" function without any laborious programming.
- Safe isolation of the drive from main power supply: The isolating functions according to IEC 60947-1 offer protection against inadvertent activation during plant maintenance.

Motor starters in the process industry

For the ET 200SP motor starters, special BaseUnits are available that enable the device to be used in the ET 200SP HA I/O system, too. This is typically used in process engineering applications.

Technical specifications

More information

Industry Mall, see www.siemens.com/product?3RK1308

Equipment Manual, see <https://support.industry.siemens.com/cs/ww/en/view/109479973>

FAQs, see <https://support.industry.siemens.com/cs/ww/en/ps/21800/faq>

ET 200SP motor starters

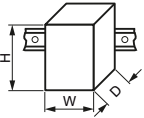
Article number	3RK1308-0AA00-0CP0	3RK1308-0AB00-0CP0	3RK1308-0AC00-0CP0	3RK1308-0AD00-0CP0	3RK1308-0AE00-0CP0	
	3RK1308-0BA00-0CP0	3RK1308-0BB00-0CP0	3RK1308-0BC00-0CP0	3RK1308-0BD00-0CP0	3RK1308-0BE00-0CP0	
Product category	Motor starters					
General technical specifications:						
Width x height x depth	mm	30 x 142 x 150				
						
Design of the switching contact	Hybrid					
Design of the motor protection	Electronic					
Installation altitude at height above sea level, maximum	m	4 000				
Mounting position	Vertical, horizontal, flat (observe derating)					
Type of mounting	Can be plugged into BaseUnit					
Ambient temperature	°C	-25 ... +60				
• During operation	°C	-40 ... +70				
• During transport	°C	-40 ... +70				
• During storage	°C	-40 ... +70				
Relative humidity during operation	%	10 ... 95				
Vibration resistance	15 mm up to 6 Hz; 2 g up to 500 Hz					
Shock resistance	6 g / 11 ms					
Degree of protection	IP20					
Type of coordination	1					
Electrical data:						
Supply voltage at DC rated value	V	24				
Operational power for AC-53a at 400 V rated value	kW	0.12	0.25	1.1	4	5.5
Operating frequency, rated value	Hz	50 ... 60				
Ultimate short-circuit current breaking capacity (I_{cu})						
• at 400 V rated value	kA	55				
• at 500 V rated value	kA	55				
Adjustable current response value of the inverse-time delayed overload release	A	0.1 ... 0.4	0.3 ... 1	0.9 ... 3	2.8 ... 9	4 ... 12
Max. current carrying capacity at startup	A	4	10	30	90	100
Max. permissible voltage for protective separation between main and auxiliary circuit	V	500				
Insulation voltage, rated value	V	500				
Trip class	CLASS 5 and 10 adjustable					

Load Feeders and Motor Starters for Use in the Control Cabinet

ET 200SP motor starters

ET 200SP fail-safe motor starters

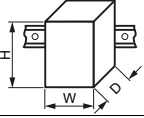
Article number		3RK1308-0CA00-0CP0	3RK1308-0CB00-0CP0	3RK1308-0CC00-0CP0	3RK1308-0CD00-0CP0	3RK1308-0CE00-0CP0
		3RK1308-0DA00-0CP0	3RK1308-0DB00-0CP0	3RK1308-0DC00-0CP0	3RK1308-0DD00-0CP0	3RK1308-0DE00-0CP0
Product category		Motor starters				
General technical specifications:						
Width x height x depth	mm	30 x 142 x 150				
						
Design of the switch contact		Hybrid				
Design of the motor protection		Electronic				
Installation altitude at height above sea level, maximum	m	2 000				
Mounting position		Vertical, horizontal, flat (observe derating)				
Type of mounting		Can be plugged into BaseUnit				
Ambient temperature						
• During operation	°C	-25 ... +60				
• During transport	°C	-40 ... +70				
• During storage	°C	-40 ... +70				
Relative humidity during operation	%	10 ... 95				
Vibration resistance		15 mm up to 6 Hz; 2 g up to 500 Hz				
Shock resistance		6 g / 11 ms				
Degree of protection		IP20				
Type of coordination		1				
Electrical data:						
Supply voltage at DC rated value	V	24				
Operational power for AC-53a at 400 V, rated value	kW	0.12	0.25	1.1	4	5.5
Operating frequency, rated value	Hz	50 ... 60				
Ultimate short-circuit current breaking capacity (I_{cu})						
• at 400 V rated value	kA	55				
• at 500 V rated value	kA	55				
Adjustable current response value of the inverse-time delayed overload release	A	0.1 ... 0.4	0.3 ... 1	0.9 ... 3	2.8 ... 9	4 ... 12
Max. current carrying capacity at startup	A	4	10	30	90	100
Max. permissible voltage for protective separation between main and auxiliary circuit	V	500				
Insulation voltage, rated value	V	500				
Trip class		CLASS 5 and 10 adjustable				

Load Feeders and Motor Starters for Use in the Control Cabinet

ET 200SP motor starters

BaseUnits for motor starters

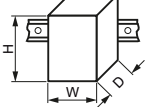
Article number	3RK1908-0AP00-0AP0	3RK1908-0AP00-0BP0	3RK1908-0AP00-0CP0	3RK1908-0AP00-0DP0	3RK1908-0AP00-0GP0	3RK1908-0AP00-0HP0	3RK1908-0AP00-0JP0	3RK1908-0AP00-0KP0
Product designation	BaseUnit							
General technical specifications:								
Width x height x depth	mm	30 × 215 × 75						
								
Ambient temperature								
• During operation	°C	-25 ... +60						
• During transport	°C	-40 ... +70						
• During storage	°C	-40 ... +70						
Degree of protection	IP20							
Touch protection against electric shock	Finger-safe							
Connections/terminals:								
Type of connectable conductor cross-sections								
• At the inputs for supply voltage								
- Solid		1 x 0.5 ... 2.5 mm ²	--					
- Finely stranded with end sleeve		1 x 0.5 ... 2.5 mm ²	--					
- Finely stranded without end sleeve		1 x 0.5 ... 2.5 mm ²	--					
- Solid for AWG cables		1 x 20 ... 12	--					
• For infeed								
- Solid		1 x 1 ... 6 mm ²	--	1 x 1 ... 6 mm ²	--	1 x 1 ... 6 mm ²	--	
- Finely stranded with end sleeve		1 x 1 ... 6 mm ²	--	1 x 1 ... 6 mm ²	--	1 x 1 ... 6 mm ²	--	
- Finely stranded without end sleeve		1 x 1 ... 6 mm ²	--	1 x 1 ... 6 mm ²	--	1 x 1 ... 6 mm ²	--	
- Solid for AWG cables		1 x 18 ... 10	--	1 x 18 ... 10	--	1 x 18 ... 10	--	
• For load-side outgoing feeder								
- Solid		1 x 0.5 ... 2.5 mm ²						
- Finely stranded with end sleeve		1 x 0.5 ... 2.5 mm ²						
- Finely stranded without end sleeve		1 x 0.5 ... 2.5 mm ²						
- Solid for AWG cables		1 x 20 ... 12						
Type of electrical connection for auxiliary and control circuits	Spring-loaded terminals (push-in)							
Miscellaneous:								
Type of screwdriver tip	Slotted							
Size of screwdriver tip	Standard screwdriver 0.6 mm x 3.5 mm							

3DI/LC control module

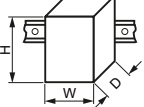
Article number	3RK1908-1AA00-0BP0	
Product designation	3DI/LC control module	
General technical specifications:		
Width x height x depth	mm	30 x 54.5 x 42.3
		
Type of product	Accessories	
Number of digital inputs	4	
Installation altitude at height above sea level, maximum	m	2 000
Mounting position	Vertical, horizontal, flat	
Type of mounting	Can be plugged onto motor starter	
Ambient temperature		
• During operation	°C	-25 ... +60
• During transport	°C	-40 ... +70
• During storage	°C	-40 ... +70
Connections/terminals:		
Connectable conductor cross-section for auxiliary contacts		
• Solid or stranded	mm ²	0.2 ... 1.5
• Finely stranded with end sleeve	mm ²	0.25 ... 1.5
• Finely stranded without end sleeve	mm ²	0.2 ... 1.5
AWG number as coded connectable conductor cross-section	24 ... 16	
Type of electrical connection for auxiliary and control circuits	Spring-loaded terminals (push-in)	
Electrical data:		
Type of voltage of the control supply voltage	DC	
Control supply voltage at DC rated value	V	20.4 ... 28.8
Miscellaneous:		
Type of screwdriver tip	Slotted	
Size of screwdriver tip	Standard screwdriver 0.6 mm x 3.5 mm	

Load Feeders and Motor Starters for Use in the Control Cabinet

ET 200SP motor starters **IE3/IE4 ready**

Selection and ordering data

	Adjustable current response value of the inverse-time delayed overload release	Max. current carrying capacity at startup	SD	Article No.	Price per PU	PU (UNIT, SET, M)	PS*	PG
	A	A	d					
Motor starters								
Direct-on-line starters								
	0.1 ... 0.4	4	NEW 2	3RK1308-0AA00-0CP0		1	1 unit	42D
	0.3 ... 1	10	2	3RK1308-0AB00-0CP0		1	1 unit	42D
	0.9 ... 3	30	2	3RK1308-0AC00-0CP0		1	1 unit	42D
	2.8 ... 9	90	2	3RK1308-0AD00-0CP0		1	1 unit	42D
	4 ... 12	100	2	3RK1308-0AE00-0CP0		1	1 unit	42D
Reversing starters								
	0.1 ... 0.4	4	NEW 2	3RK1308-0BA00-0CP0		1	1 unit	42D
	0.3 ... 1	10	2	3RK1308-0BB00-0CP0		1	1 unit	42D
	0.9 ... 3	30	2	3RK1308-0BC00-0CP0		1	1 unit	42D
	2.8 ... 9	90	2	3RK1308-0BD00-0CP0		1	1 unit	42D
	4 ... 12	100	2	3RK1308-0BE00-0CP0		1	1 unit	42D
Fail-safe direct-on-line starters								
	0.1 ... 0.4	4	NEW 2	3RK1308-0CA00-0CP0		1	1 unit	42D
	0.3 ... 1	10	2	3RK1308-0CB00-0CP0		1	1 unit	42D
	0.9 ... 3	30	2	3RK1308-0CC00-0CP0		1	1 unit	42D
	2.8 ... 9	90	2	3RK1308-0CD00-0CP0		1	1 unit	42D
	4 ... 12	100	2	3RK1308-0CE00-0CP0		1	1 unit	42D
Fail-safe reversing starters								
	0.1 ... 0.4	4	NEW 2	3RK1308-0DA00-0CP0		1	1 unit	42D
	0.3 ... 1	10	2	3RK1308-0DB00-0CP0		1	1 unit	42D
	0.9 ... 3	30	2	3RK1308-0DC00-0CP0		1	1 unit	42D
	2.8 ... 9	90	2	3RK1308-0DD00-0CP0		1	1 unit	42D
	4 ... 12	100	2	3RK1308-0DE00-0CP0		1	1 unit	42D

Load Feeders and Motor Starters for Use in the Control Cabinet

ET 200SP motor starters

Type of product	Operational voltage of the AC infeed	Supply voltage of the DC infeed	SD	Push-in terminals	Price per PU	PU (UNIT, SET, M)	PS*	PG
	V	V	d	Article No.				

BaseUnits¹⁾

3RK1908-0AP00-0AP0

For motor starters

• with AC/DC infeed	500	24	2	3RK1908-0AP00-0AP0		1	1 unit	42D
• with DC infeed	--	24	2	3RK1908-0AP00-0BP0		1	1 unit	42D
• with AC infeed	500	--	2	3RK1908-0AP00-0CP0		1	1 unit	42D
• without infeed	--	--	2	3RK1908-0AP00-0DP0		1	1 unit	42D

For fail-safe motor starters NEW

• with AC infeed, with F-DI infeed for fail-safe motor starters	500	--	2	3RK1908-0AP00-0GP0		1	1 unit	42D
• with AC infeed, with F-DI loop-through for fail-safe motor starters	500	--	2	3RK1908-0AP00-0HP0		1	1 unit	42D
• without AC/DC infeed, with F-DI loop-through for fail-safe motor starters	--	--	2	3RK1908-0AP00-0JP0		1	1 unit	42D
• without AC/DC infeed, with F-DI infeed for fail-safe motor starters	--	--	2	3RK1908-0AP00-0KP0		1	1 unit	42D

¹⁾ The voltage is looped-through from BaseUnits with infeed to subsequent BaseUnits without infeed.

Type of product	Supply voltage at DC rated value	Loop through the potential group from the left	SD	Push-in terminals	Price per PU	PU (UNIT, SET, M)	PS*	PG
	V		d	Article No.				

BaseUnits



6ES7193-6BP00-0BA0

For dummy modules

• dark, looping through the potential group	24	Yes	1	6ES7193-6BP00-0BA0		1	1 unit	255
• light, opening a new potential group	24	No	1	6ES7193-6BP00-0DA0		1	1 unit	255

Control supply voltage at DC rated value	Product function		SD	Push-in terminals	Price per PU	PU (UNIT, SET, M)	PS*	PG
V	Local control	Digital inputs parameterizable	d	Article No.				

3DI/LC control module



3RK1908-1AA00-0BP0

20.4 ... 28.8	Yes	Yes	2	3RK1908-1AA00-0BP0		1	1 unit	42D
---------------	-----	-----	---	---------------------------	--	---	--------	-----

Load Feeders and Motor Starters for Use in the Control Cabinet

ET 200SP motor starters

	Product designation	Type of product	SD d	Article No.	Price per PU	PU (UNIT, SET, M)	PS*	PG
Accessories								
	BU cover 15 mm	for BaseUnits Type A0 or A1	1	6ES7133-6CV15-1AM0		1	5 units	255
6ES7133-6CV15-1AM0								
	BU cover 30 mm	For protection of empty slots, 30 mm	2	3RK1908-1CA00-0BP0		1	1 unit	42D
3RK1908-1CA00-0BP0								
	Infeed bus cover (1 bag containing 10 covers)	For ET 200SP	2	3RK1908-1DA00-2BP0		1	1 unit	42D
3RK1908-1DA00-2BP0								
	Mechanical bracket (1 bag containing 5 mechanical brackets)	Mechanical, for ET 200SP	2	3RK1908-1EA00-1BP0		1	1 unit	42D
3RK1908-1EA00-1BP0								
	Fan	Can be used for 3RK1308	▶	3RW4928-8VB00		1	1 unit	42G
3RW4928-8VB00								
	Motor suppression module							
	• Square		15	3RK1911-6EA00		1	1 unit	42D
3RK1911-6EA00								
	• Round		15	3RK1911-6EB00		1	1 unit	42D
3RK1911-6EB00								
	Starter Kit NEW	consists of 3RK1308-0BC00-0CP0 reversing starter (0.9 ... 3 A), 3RK1908-0AP00-0AP0 BaseUnit with 500 V and 24 V AC/DC infeed, and EMC distance module (consisting of 6ES7193-6BP00-0BA0 BaseUnit plus 6ES7133-6CV15-1AM0 BU cover 15 mm)	5	3RK1908-1SK00		1	1 unit	42D
3RK1908-1SK00								