

Switching Devices – Contactors and Contactor Assemblies – for Switching Motors

**Price groups**

PG 41B, 41E, 41H, 42F

3/2

Introduction**Power contactors for switching motors**

3/8 General data

3/17 SIRIUS 3RT contactors, 3-pole up to 250 kW

Accessories for SIRIUS 3RT contactors and SIRIUS 3RH2 contactor relays

3/75 - General data

3/87 - Auxiliary switches, instantaneous

3/100 - Auxiliary switches, delayed

3/102 - Surge suppressors

3/104 - Modules for contactor control

3/109 - Link modules

3/114 - Terminal modules/adapters **NEW**

3/117 - Covers

3/118 - Miscellaneous accessories **NEW**

Spare parts for SIRIUS 3RT contactors and SIRIUS 3RH2 contactor relays

3/121 - Solenoid coils

3/124 - Contacts and arc chutes

3/125 SIRIUS 3RT12 and 3TF6 vacuum contactors

3/137 Accessories and spare parts for SIRIUS 3RT12 and 3TF6 vacuum contactors

3/141 3TG10 power relays/miniature contactors

Reversing contactor assemblies

3/145 SIRIUS 3RA23 reversing contactor assemblies, up to 55 kW

3/156 Reversing contactor assemblies consisting of SIRIUS 3RT1 contactors, up to 250 kW

Contactor assemblies for star-delta (wye-delta) starting

3/160 SIRIUS 3RA24 contactor assemblies for star-delta (wye-delta) starting, up to 90 kW

3/173 Contactor assemblies for star-delta (wye-delta) starting consisting of SIRIUS 3RT contactors, up to 500 kW

Switching Devices – Contactors and Contactor Assemblies – for Switching Motors

Introduction

Overview

More information

Homepage, see www.siemens.com/sirius
 Industry Mall, see www.siemens.com/product?3RT_3TK_3TC

Conversion tool for article numbers, see www.siemens.com/sirius/conversion-tool
 TIA Selection Tool Cloud (TST Cloud), see <https://www.siemens.com/tstcloud/?node=Contactor>

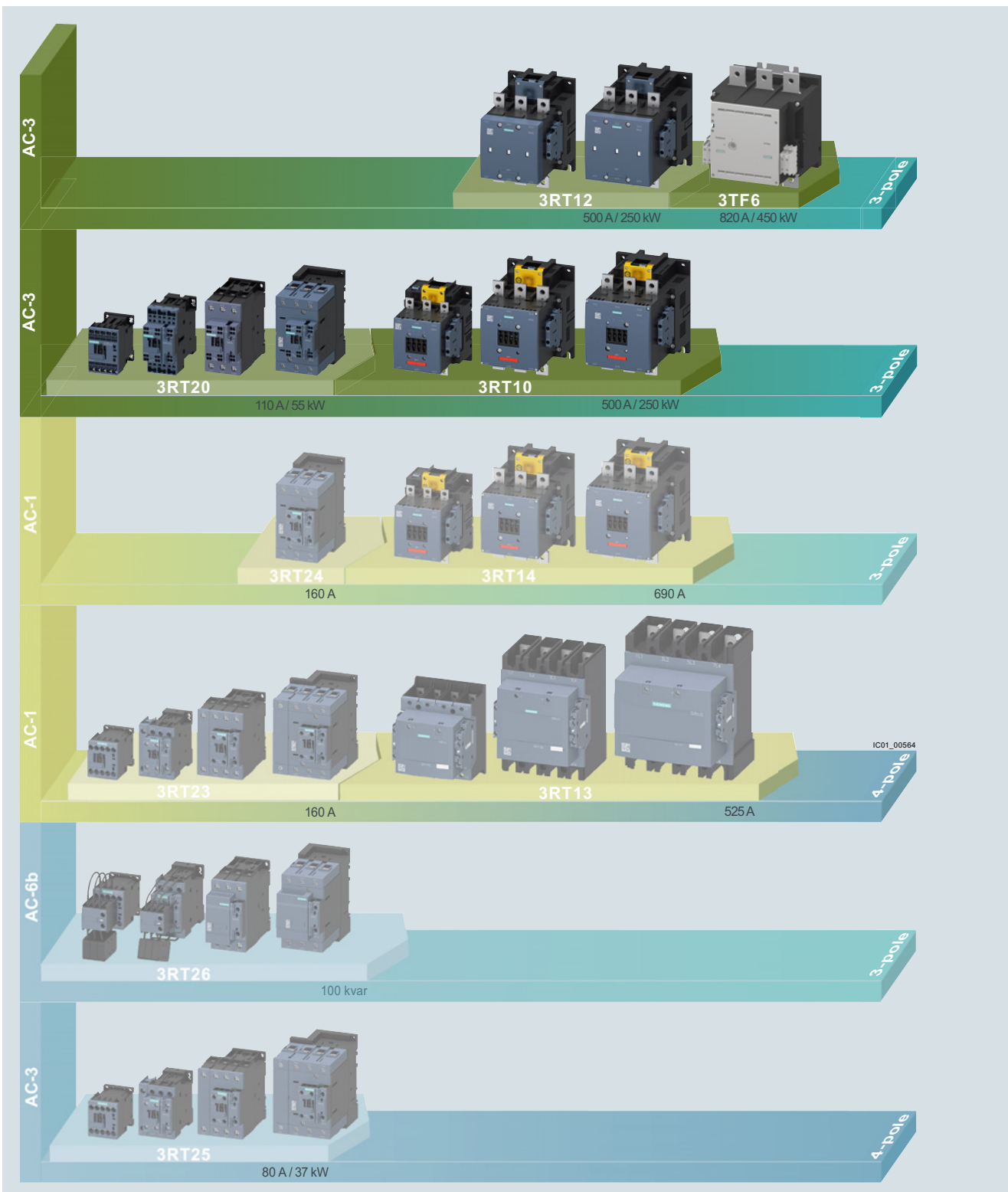

Overview of the 3RT and 3TF contactors

Switching Devices – Contactors and Contactor Assemblies – for Switching Motors

Introduction



Size		S00				S0											
Type		3RT201				3RT202											
3RT20 contactors																	
Type		3RT2015	3RT2016	3RT2017	3RT2018	3RT2023	3RT2024	3RT2025	3RT2026	3RT2027	3RT2028						
AC, DC operation		(p. 3/54, 3/59 ... 3/62)				(p. 3/55, 3/56, 3/63 ... 3/65, 3/67)											
AC-3																	
$I_{th}/AC-3/400\text{ V}$	A	7	9	12	16	9	12	17	25	32	38						
400 V	kW	3	4	5.5	7.5	4	5.5	7.5	11	15	18.5						
230 V	kW	1.5	2.2	3	4	2.2	3	4	5.5	7.5	11						
690 V	kW	4	5.5	5.5	7.5	7.5	7.5	11	11	18.5	18.5						
1 000 V	kW	--	--	--	--	--	--	--	--	--	--						
AC-4 (at $I_a = 6 \times I_e$)																	
400 V	kW	3	4	4	5.5	4	5.5	7.5	7.5	11	11						
400 V (200 000 operating cycles)	kW	1.15	2	2	2.5	2	2.6	3.5	4.4	6	6						
AC-1 (40 °C, ≤ 690 V)																	
I_e	A	18	22	22	22	40	40	40	40	50	50						
Accessories for contactors																	
Auxiliary switches	<ul style="list-style-type: none"> On front Lateral 	3RH29, 3RA28				(p. 3/93 ... 3/100)		3RH29, 3RA28				(p. 3/93 ... 3/100)					
		3RH29				(p. 3/97)		3RH29				(p. 3/97)					
Function modules	<ul style="list-style-type: none"> Direct-on-line starting, star-delta (wye-delta) starting IO-Link, AS-Interface 	3RA281.				(p. 3/105)		3RA281.				(p. 3/105)					
		3RA271.-AA00				(p. 3/106, 3/107)		3RA271.-AA00				(p. 3/106, 3/107)					
Surge suppressors		3RT2916				(p. 3/102, 3/103)		3RT2926				(p. 3/102, 3/103)					
3RU2 and 3RB3 overload relays																	
3RU thermal overload relays		3RU2116				0.11 ... 16 A		(p. 7/92)		3RU2126				1.8 ... 40 A		(p. 7/92)	
3RB electronic overload relays		3RB3016, 3RB3113				0.1 ... 16 A		(p. 7/105 ... 7/107)		3RB3026, 3RB3123				0.1 ... 40 A		(p. 7/105 ... 7/107)	
<ul style="list-style-type: none"> For standard applications 		3RB22, 3RB23 and 3RB24 with current measuring module 3RB2906-2.G1				0.3 ... 25 A		(p. 7/140)		3RB22, 3RB23 and 3RB24 with current measuring module 3RB2906-2.G1				0.3 ... 25 A		(p. 7/140)	
<ul style="list-style-type: none"> For High-Feature applications 																	
3RV20 motor starter protectors																	
Motor starter protectors		3RV2011				0.11 ... 16 A		(p. 7/28)		3RV2021				0.45 ... 40 A		(p. 7/29)	
Link modules		3RA1921, 3RA2911				(p. 7/56)		3RA2921				(p. 7/56)					
3RA23 reversing contactor assemblies																	
Complete units	Type	3RA2315	3RA2316	3RA2317	3RA2318	--	3RA2324	3RA2325	3RA2326	3RA2327	3RA2328						
		(p. 3/152)				(p. 3/153)											
400 V	kW	3	4	5.5	7.5		5.5	7.5	11	15	18.5						
Assembly kits, etc.		3RA2913-2AA.				(p. 3/109)		3RA2923-2AA.				(p. 3/109)					
Function modules		3RA271.-BA00				(p. 3/106)		3RA271.-BA00				(p. 3/106)					
3RA24 contactor assemblies for star-delta (wye-delta) starting																	
Complete units	Type	3RA2415	3RA2416	3RA2417		3RA2423		3RA2425	3RA2426								
		(p. 3/169)				(p. 3/170)											
400 V	kW	5.5	7.5	11		11		15/18.5	22								
Assembly kits/wiring modules		3RA2913-2BB.				(p. 3/110)		3RA2923-2BB.				(p. 3/110)					
Function modules		3RA271.-CA00				(p. 3/106)		3RA271.-CA00				(p. 3/106)					

Note:

Safety characteristics for contactors, see "Standards and approvals", page 16/6.

Switching Devices – Contactors and Contactor Assemblies – for Switching Motors

Introduction



Size	S2				S3					
Type	3RT203				3RT204					
3RT20 contactors										
Type	3RT2035	3RT2036	3RT2037	3RT2038	3RT2045	3RT2046	3RT2047			
AC, DC operation	(p. 3/57, 3/66, 3/68)				(p. 3/58, 3/66, 3/69)					
AC-3										
$I_{th}/AC-3/400\text{ V}$	A	40	50	65	80	80	95	110		
400 V	kW	18.5	22	30	37	37	45	55		
230 V	kW	11	15	18.5	22	22	22	30		
690 V	kW	22	22	37	45	55	75	90		
1 000 V	kW	--	--	--	--	37	37	37		
AC-4 (at $I_a = 6 \times I_e$)										
400 V	kW	18.5	22	30	37	37	45	55		
400 V (200 000 operating cycles)	kW	11.6	12.6	14.7	15.8	17.9	22	24.3		
AC-1 (40 °C, ≤ 690 V)										
I_e	A	60	70	80	90	125	130	130		
Accessories for contactors										
Auxiliary switches	<ul style="list-style-type: none"> On front Lateral 	3RH29, 3RA28 3RH29			(p. 3/93 ... 3/100) (p. 3/97)	3RH29, 3RA28 3RH29		(p. 3/93 ... 3/100) (p. 3/97)		
Function modules	<ul style="list-style-type: none"> Direct-on-line starting IO-Link, AS-Interface 	3RA283. 3RA271.-.AA00			(p. 3/105) (p. 3/106, 3/107)	3RA283. 3RA271.-.AA00		(p. 3/105) (p. 3/106, 3/107)		
Surge suppressors		3RT2936			(p. 3/102, 3/103)	3RT2936¹⁾, 3RT2946		(p. 3/102, 3/103)		
Terminal covers		3RT2936-4EA2			(p. 3/117)	3RT2946-4EA2		(p. 3/117)		
3RU2 and 3RB overload relays										
3RU thermal overload relays		3RU2136	11 ... 80 A		(p. 7/93)	3RU2146	28 ... 100 A		(p. 7/93)	
3RB electronic overload relays		3RB3036, 3RB3133	12.5 ... 80 A		(p. 7/105 ... 7/107)	3RB3046, 3RB3143	12.5 ... 115 A		(p. 7/105 ... 7/107)	
<ul style="list-style-type: none"> For standard applications 		3RB22, 3RB23 and 3RB24 with current measuring module 3RB2906-2JG1	10 ... 100 A		(p. 7/128, 7/136) (p. 7/140)	3RB22, 3RB23 and 3RB24 with current measuring module 3RB2906-2JG1	10 ... 100 A		(p. 7/128, 7/136) (p. 7/140)	
<ul style="list-style-type: none"> For High-Feature applications 										
3RV20 motor starter protectors										
Motor starter protectors		3RV2031, 3RV2032		9.5 ... 80 A		(p. 7/30)	3RV2041, 3RV2042		28 ... 100 A	(p. 7/30)
Link modules		3RA2931				(p. 7/56)	3RA1941			(p. 7/56)
3RA23 reversing contactor assemblies										
Complete units	Type	3RA2335 (p. 3/154)	3RA2336	3RA2337	3RA2338	3RA2345 (p. 3/155)	3RA2346	3RA2347		
400 V	kW	18.5	22	30	37	37	45	55		
Assembly kits/wiring modules		3RA2933-2AA.			(p. 3/109)	3RA2943-2AA.			(p. 3/109)	
Function modules		3RA271.-.BA00			(p. 3/106)	3RA271.-.BA00			(p. 3/106)	
Mechanical interlocks		3RA2934-2B			(p. 3/113)	3RA2934-2B			(p. 3/113)	
3RA24 contactor assemblies for star-delta (wye-delta) starting										
Complete units	Type	3RA2434 (p. 3/171)	3RA2435	3RA2436	3RA2437	3RA2444 (p. 3/172)	3RA2445	3RA2446		
400 V	kW	22/30	37	45	55	55	75	90		
Assembly kits/wiring modules		3RA2933-2BB./-2C			(p. 3/110)	3RA2943-2BB./-2C			(p. 3/110)	
Function modules		3RA271.-.CA00			(p. 3/106)	3RA271.-.CA00			(p. 3/106)	

¹⁾ From product version E03 onwards, 3RT2936-1B/-1E surge suppressors can be used for 3RT2.4 contactors. When using an AC/DC coil, the surge suppressor is already integrated in the electronics.

Note:

Safety characteristics for contactors, see "Standards and approvals", page 16/6.



Size	S6			S10			S12		
Type	3RT105			3RT1.6			3RT1.7		
3RT10 contactors · 3RT12 vacuum contactors									
Type	3RT1054	3RT1055	3RT1056	3RT1064	3RT1065	3RT1066	3RT1075	3RT1076	
AC, DC operation	(p. 3/70 ... 3/72)			(p. 3/70 ... 3/72)			(p. 3/70 ... 3/72)		
Type	--	--	--	3RT1264	3RT1265	3RT1266	3RT1275	3RT1276	
				(p. 3/134)			(p. 3/134)		
AC-3									
I_e /AC-3/400 V	A	115	150	185	225	265	300	400	500
400 V	kW	55	75	90	110	132	160	200	250
230 V	kW	37	45	55	55	75	90	132	160
690 V	3RT10/3RT12 kW	110	132	160	200	250	250	400	400/500
1 000 V	3RT10/3RT12 kW	75	90	90	90/315	132/355	132/400	250/560	250/710
AC-4 (at $I_a = 6 \times I_e$)									
400 V	kW	55	75	90	110	132	160	200	250
400 V	3RT10/3RT12 kW	29	38	45	54/78	66/93	71/112	84/140	98/161
(200 000 operating cycles)									
AC-1 (40 °C, ≤ 690 V)									
I_e	3RT10/3RT12 A	160	185	215	275/330	330	330	430/610	610
3RT14 AC-1 contactors									
Type	3RT1456	(p. 4/15, 4/16)			3RT1466	3RT1467	(p. 4/15, 4/16)		3RT1476
									(p. 4/15, 4/16)
I_e /AC-1/40 °C/≤ 690 V	A	275			400	500		690	
Accessories for contactors									
Auxiliary switches	• On front • Lateral	3RH19, 3RT1926						(p. 3/96, 3/101) (p. 3/98, 3/99)	
Surge suppressors		3RT1956-1C (RC element)						(p. 3/103)	
Terminal covers		3RT1956-4EA.			(p. 3/117)		3RT1966-4EA.		(p. 3/117)
Box terminal blocks		3RT1955-4G, 3RT1956-4G			(p. 3/115)		3RT1966-4G		(p. 3/115)
3RB2 overload relays									
3RB electronic overload relays									
• For standard applications		3RB2056	50 ... 200 A	(p. 7/117, 7/118)	3RB2066	55 ... 250 A or 160 ... 630 A	(p. 7/117, 7/118)		
		3RB2153	50 ... 200 A	(p. 7/119)	3RB2163	55 ... 250 A or 160 ... 630 A	(p. 7/119)		
• For High-Feature applications		3RB22, 3RB23 and 3RB24			3RB22, 3RB23 and 3RB24			(p. 7/128)	
		with current measuring module 3RB2956-2TH2			with current measuring module 3RB2966-2WH2			(p. 7/136)	
		20 ... 200 A			63 ... 630 A			(p. 7/140)	
3RV10 molded case motor starter protectors									
Molded case motor starter protectors		3RV1063	40 ... 200 A	(p. 7/75)	3RV1073	160 ... 400 A	(p. 7/75)	3RV1083	252 ... 630 A (p. 7/75)
Reversing contactor assemblies¹⁾									
Complete units	Type	--							
400 V	kW	55	75	90	110	132	160	200	250
Assembly kits/wiring modules		3RA1953-2A			(p. 3/109)		3RA1963-2A		(p. 3/109)
							3RA1973-2A		(p. 3/109)
Mechanical interlocks		3RA1954-2A			(p. 3/113)				
Contactor assemblies for star-delta (wye-delta) starting¹⁾									
Complete units	Type	--							
400 V	kW	--							
Assembly kits/wiring modules		3RA1953-2B			(p. 3/111)		3RA1963-2B		(p. 3/111)
							3RA1973-2B		(p. 3/111)

¹⁾ Contactor assemblies for customer assembly:
 - Reversing contactor assemblies, see pages 3/157 to 3/159,
 - Contactor assemblies for star-delta (wye-delta) starting, see pages 3/174 to 3/179.

Note:

Safety characteristics for contactors, see "Standards and approvals", page 16/6.

Switching Devices – Contactors and Contactor Assemblies – for Switching Motors

Introduction



Size **14**
Type **3TF6**

3TF68/3TF69 vacuum contactors

Type	3TF68 (p. 3/135, 3/136)	3TF69 (p. 3/135, 3/136)
------	-----------------------------------	-----------------------------------

AC-3

I_e /AC-3/400 V	A	630	820
400 V	kW	335	450
230 V	kW	200	260
690 V	kW	600	800
1 000 V	kW	600	800

AC-4 (at $I_a = 6 \times I_e$)

400 V	kW	355	400
400 V	kW	168	191
(200 000 operating cycles)			

AC-1 (40 °C, ≤ 690 V)

I_e	A	700	910
-------	----------	------------	------------

Accessories for contactors

Auxiliary switches

• Lateral	3TY7561	(p. 3/137)
-----------	----------------	------------

Surge suppressors	3TX7572	(p. 3/138)
--------------------------	----------------	------------

Terminal covers	3TX7686, 3TX7696	(p. 3/138)
------------------------	-------------------------	------------

3RB2 overload relays

3RB electronic overload relays

• For standard applications	3RB2066, 3RB2163	55 ... 250 A or 160 ... 630 A	(p. 7/117, 7/118) (p. 7/119)	3RB22, 3RB23 and 3RB24 with current measuring module 3RB2906-2.G1 with 3UF series transformer up to 820 A	(p. 7/128, 7/136) (p. 7/140)
• For High-Feature applications	3RB22, 3RB23 and 3RB24 with current measuring module 3RB2966-2WH2	63 ... 630 A	(p. 7/128, 7/136) (p. 7/140)	63 ... 820 A	

3RV10 molded case motor starter protectors

Molded case motor starter protectors	3RV1083	252 ... 630 A	(p. 7/75)
---	----------------	---------------	-----------

Reversing contactor assemblies

Complete units	Type	--
-----------------------	------	----

400 V	kW	335
--------------	-----------	------------

Assembly kits/wiring modules	3TX7680-1A	(Industry Mall)
-------------------------------------	-------------------	-----------------

Mechanical interlocks	3TX7686-1A	(Industry Mall)
------------------------------	-------------------	-----------------

Contactor assemblies for star-delta (wye-delta) starting

Complete units	Type	--
-----------------------	------	----

400 V	kW	630
--------------	-----------	------------

Assembly kits/wiring modules	3TX7680-1B	(Industry Mall)
-------------------------------------	-------------------	-----------------

Note:

Safety characteristics for contactors, see "Standards and approvals", page 16/6.



Size	--
Type	3TG10

3TG10 power relays/miniature contactors

Type	3TG10
Number of main contacts	4
AC, DC operation	(p. 3/141)

AC-1

I_e at 400 V	55 °C	A	20
P at 400 V		kW	13
At 230 V		kW	7.5

AC-2 and AC-3

I_e up to 400 V		A	8.4
P at 400 V		kW	4

Connection methods

The contactors are available with screw terminals (box terminals or flat connectors) or with spring-loaded terminals.

The 3TG10 power relays/miniature contactors are available with screw terminals or flat connectors.



Screw terminals



Spring-loaded terminals



Flat connectors

The terminals are indicated in the corresponding tables by the symbols shown on orange backgrounds.

Use of 3RT contactors, 3RT and 3TF vacuum contactors, reversing contactor assemblies, and contactor assemblies for star-delta (wye-delta) starting with IE3/IE4 motors

Note:

For the use of 3RT contactors, 3RT and 3TF vacuum contactors, reversing contactor assemblies and contactor assemblies for star-delta (wye-delta) starting in conjunction with highly energy-efficient IE3/IE4 motors, please observe the information on dimensioning and configuring, [see Application Manual](#).

For more information, [see page 1/7](#).

Switching Devices – Contactors and Contactor Assemblies – for Switching Motors

Power Contactors for Switching Motors

General data

Overview

The SIRIUS family of controls

The SIRIUS modular system with its components for the switching, starting, protection and monitoring of motors and industrial systems stands for the fast, flexible and space-saving construction of control cabinets.

3RT2.1 contactors · Size S00 with mountable accessories

The figure shows the version with screw terminals

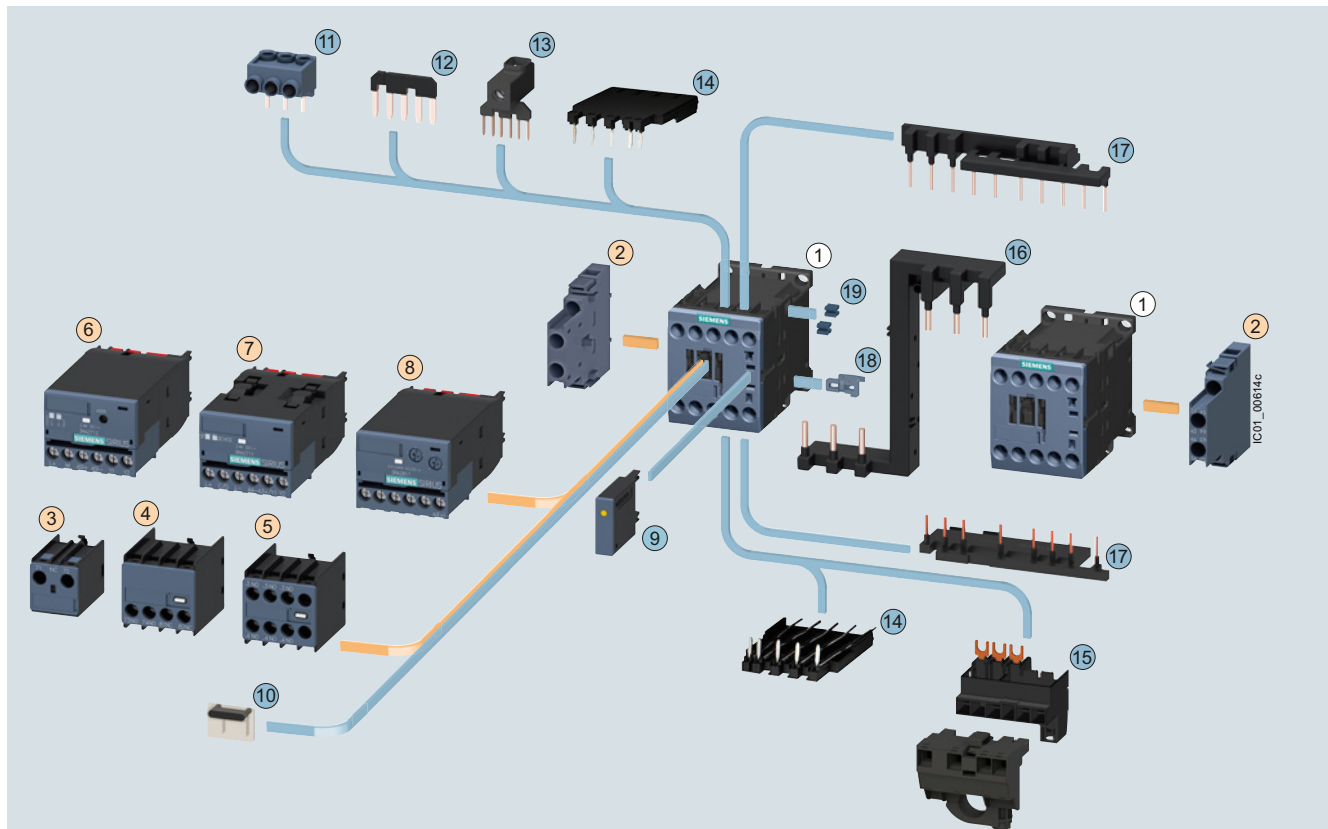

① Contactor, size S00

② 2-pole auxiliary switch, laterally mountable

③ 1-pole auxiliary switch, for snapping onto the front cable entry from the top

④ 2-pole auxiliary switch, for snapping onto the front cable entry from the bottom

⑤ 4-pole auxiliary switch, for snapping onto the front

⑥ 3RA27 function module for AS-Interface

⑦ 3RA27 function module for IO-Link

⑧ 3RA28 function module

⑨ Surge suppressor with/without LED

⑩ Cover, sealable

⑪ Three-phase infeed terminal

⑫ Star jumper, 3-pole, without connecting terminal

⑬ Link for paralleling, 3-pole, with connecting terminal

⑭ Solder pin adapter

⑮ Connection module (adapter and connector) for contactors with screw terminals

⑯ Safety main current connector for two contactors

Assembly kit 3RA2913-2AA1 comprising:

⑰ Wiring modules on the top and bottom for connecting the main, auxiliary and control current paths, electrical interlock¹⁾ included, interruptible (NC contact interlock)

⑱ Mechanical interlocks²⁾

⑲ Two connecting clips for two contactors²⁾

○ For contactors

● For contactors and coupling contactors

¹⁾ 3RT201. contactors with one NC contact in the basic unit are required for the electrical interlock. An additional NO contact is required for momentary-contact operation.

²⁾ The parts ⑱ and ⑲ can only be ordered together as 3RA2912-2H mechanical connectors.

Accessories and spare parts, see pages 3/75 to 3/124.

Switching Devices – Contactors and Contactor Assemblies – for Switching Motors

Power Contactors for Switching Motors

General data

3RT2.2 contactors · Size S0 with mountable accessories

The figure shows the version with screw terminals

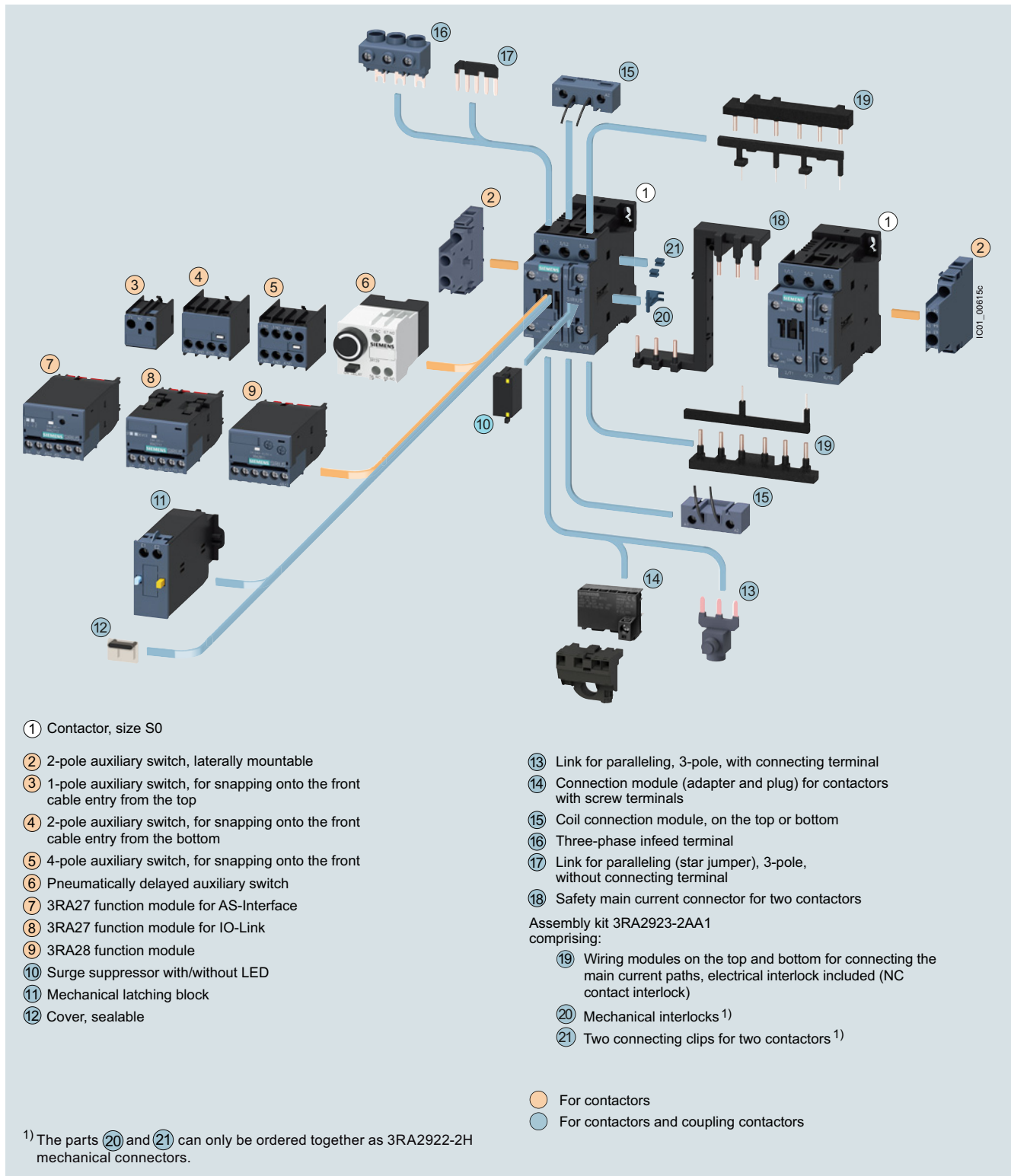

Accessories and spare parts, see pages 3/75 to 3/124.

Switching Devices – Contactors and Contactor Assemblies – for Switching Motors

Power Contactors for Switching Motors

General data

3RT2.3 contactors · Size S2 with mountable accessories

The figure shows the version with screw terminals

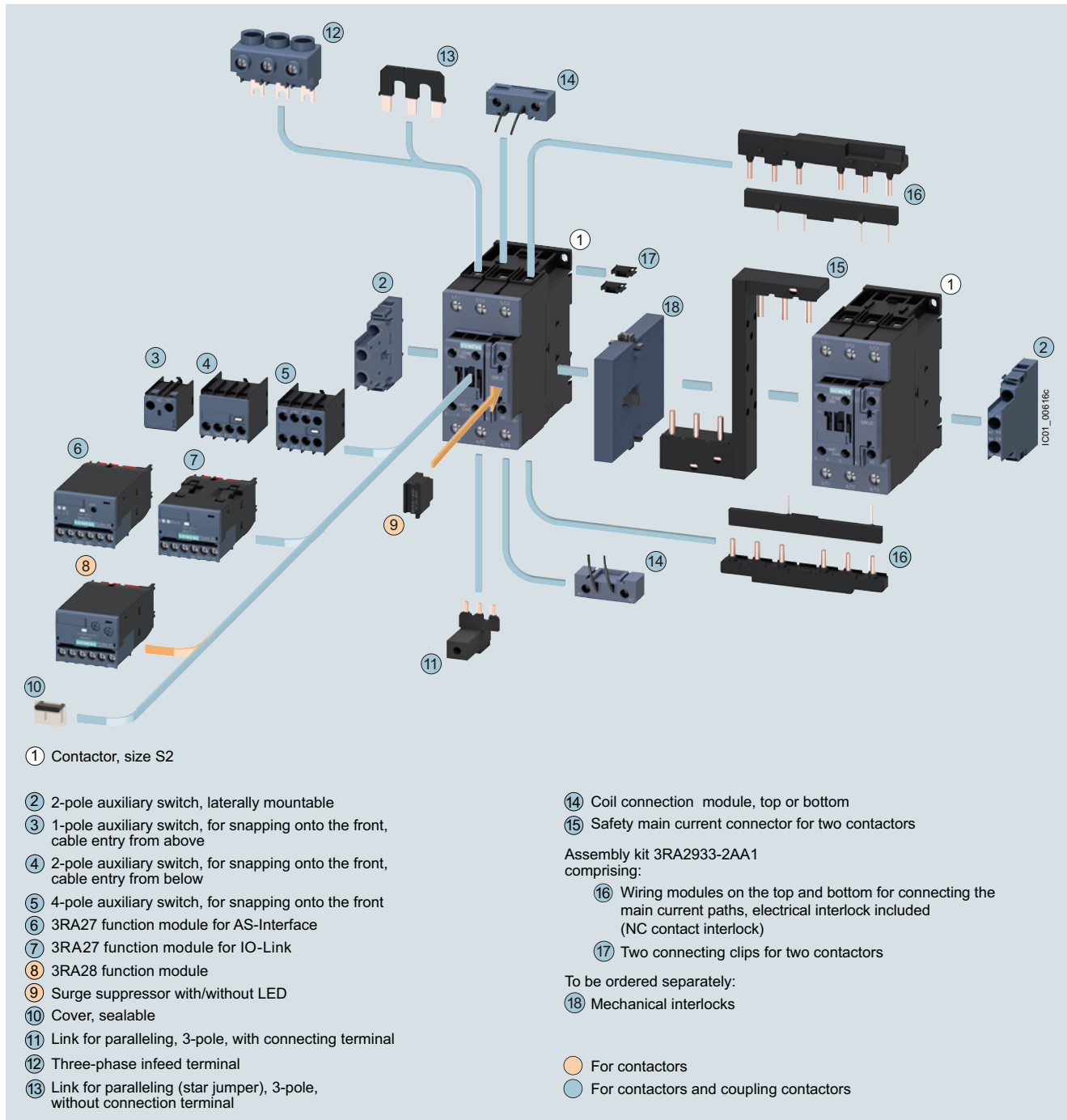

Accessories and spare parts, see pages 3/75 to 3/124.

Switching Devices – Contactors and Contactor Assemblies – for Switching Motors

Power Contactors for Switching Motors

General data

3RT2.4 contactors · Size S3 with mountable accessories

The figure shows the version with screw terminals

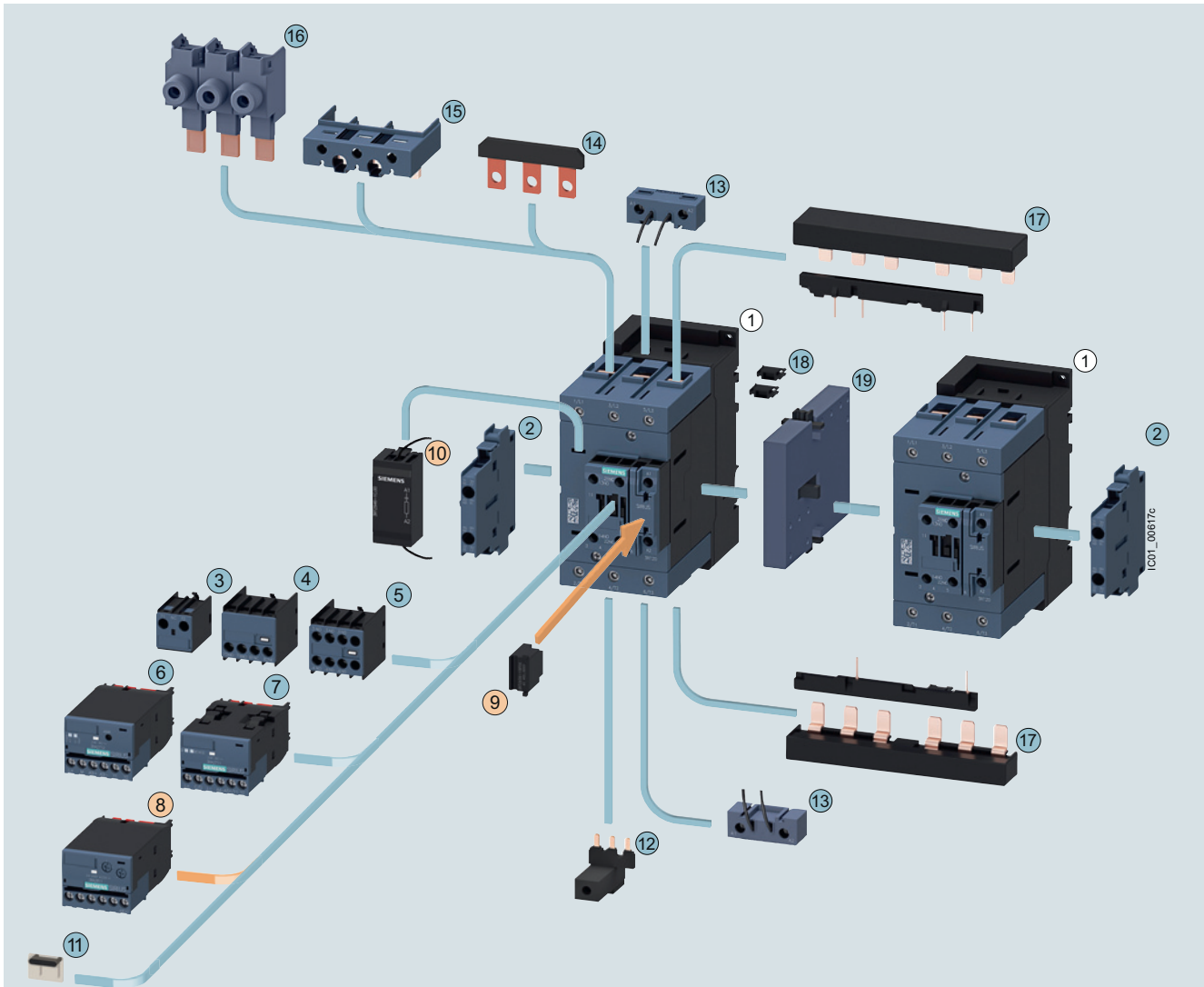

① Contactor, size S3

- ② 2-pole auxiliary switch block, laterally mountable
- ③ 1-pole auxiliary switch block, for snapping onto the front, cable entry from above
- ④ 2-pole auxiliary switch block, for snapping onto the front, cable entry from below
- ⑤ 4-pole auxiliary switch block, for snapping onto the front
- ⑥ 3RA27 function module for AS-Interface
- ⑦ 3RA27 function module for IO-Link
- ⑧ 3RA28 function module
- ⑨ Surge suppressor with/without LED (Varistor, diode assembly), can be plugged in on the front
- ⑩ Surge suppressor without LED (RC element), can be plugged in on the front in the recesses on the left next to the connection block
- ⑪ Cover, sealable

- ⑫ Links for paralleling, 3-pole, with connecting terminal
- ⑬ Coil connection module, top or bottom
- ⑭ Links for paralleling (star jumper), 3-pole without connecting terminal
- ⑮ Auxiliary terminal, 3-pole
- ⑯ Single-phase infeed terminals (3 units)

Assembly kit 3RA2943-2AA1 comprising:

- ⑰ Wiring modules on the top and bottom for connecting the main, auxiliary and control current paths, electrical interlock¹⁾ included, interruptible (NC contact interlock)
- ⑱ Two connectors for two contactors

To be ordered separately:

- ⑲ Mechanical interlock

¹⁾ 3RT201. contactors with one NC contact in the basic unit are required for the electrical interlock. An additional NO contact is required for momentary-contact operation.

- For contactors
- For contactors and coupling contactors

Accessories and spare parts, see pages 3/75 to 3/124.

Switching Devices – Contactors and Contactor Assemblies – for Switching Motors

Power Contactors for Switching Motors

General data

3RT105 and 3RT145 contactors · Size S6 with mountable accessories

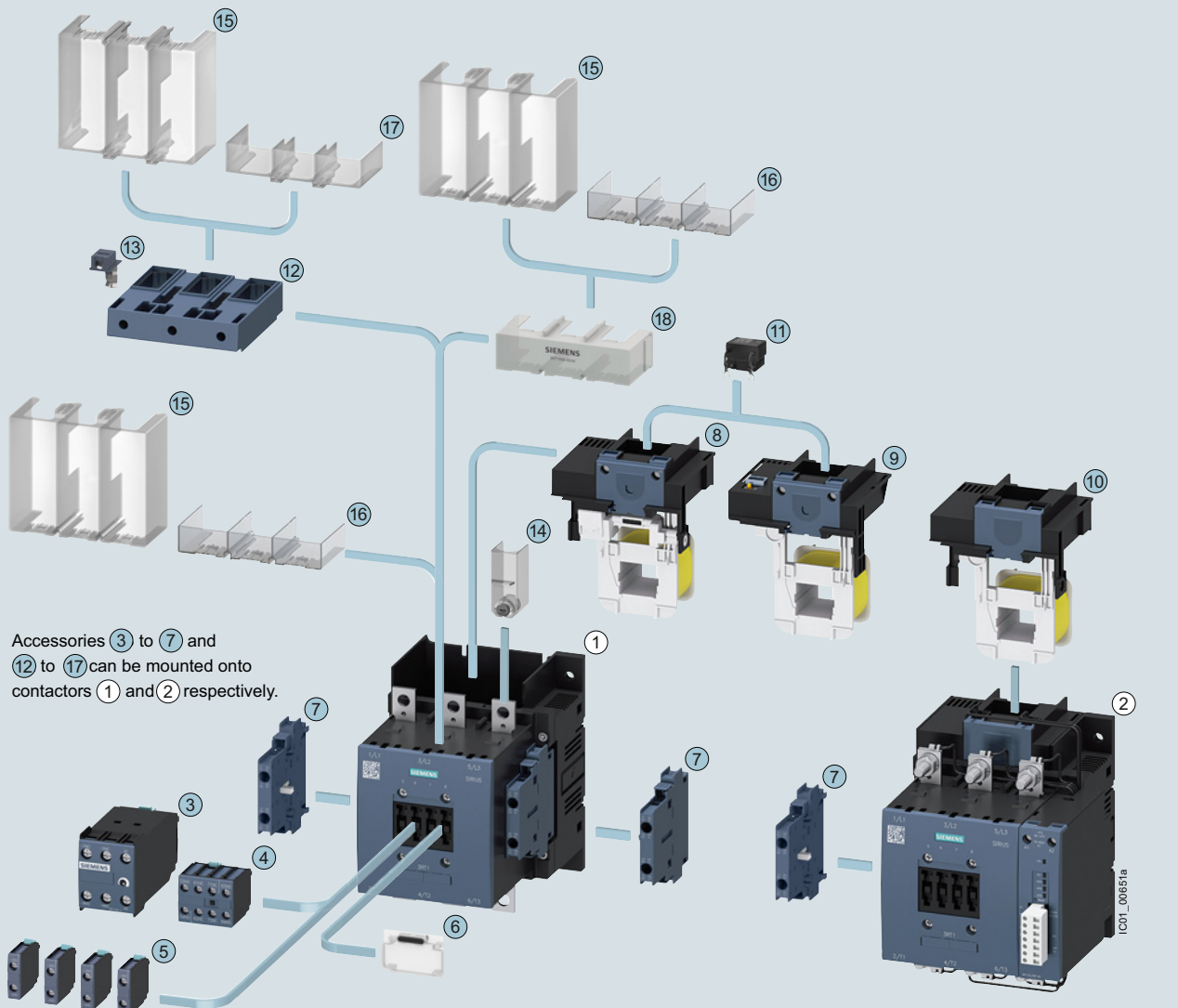

① 3RT105 and 3RT145 air-break contactors, size S6 (version without withdrawable coil)

② 3RT105.-P and 3RT145.-P air-break contactors with solid-state operating mechanism and remaining lifetime indicator, size S6 (version with withdrawable coil and laterally mountable add-on module)

Can be mounted onto the front of contactors ① and ②

- ③ 3RT1926: Auxiliary switch block, electronically delayed (ON-delay or OFF-delay or star-delta (wye-delta) starting)
- ④ 3RH192: 4-pole auxiliary switch
- ⑤ 3RH192: 1-pole auxiliary switch (max. four can be snapped on)
- ⑥ 3RT1926-4MA10: Cover, sealable

Can be mounted onto the side of contactors ① and ②

- ⑦ 3RH192: 2-pole auxiliary switch

Can be inserted in top of contactors

- ⑧ 3RT1955-5A.3.: Withdrawable coil, standard operating mechanism
- ⑨ 3RT1955-5N.3.: Withdrawable coil, solid-state operating mechanism
- ⑩ 3RT1955-5P.3.: Withdrawable coil, solid-state operating mechanism and remaining lifetime indicator

Can be plugged onto the top of contactor operating mechanisms ⑧ and ⑨

- ⑪ 3RT1956-1C: Surge suppressor (RC element)

Can be mounted onto the top or bottom on busbars or box terminals of contactors ① and ②

- ⑫ 3RT1956-4G: Box terminal block
- ⑬ 3TX7500-0A: Auxiliary terminal, 1-pole
- ⑭ 3TX6526-3B: Terminal cover (can be screwed on), covers one busbar connection
- ⑮ 3RT1956-4EA1: Terminal cover for busbar connection and on box terminal
- ⑯ 3RT1956-4EA3: Terminal cover for busbar connection
- ⑰ 3RT1956-4EA2: Terminal cover on box terminal
- ⑱ 3RT1956-4EA4: Terminal cover for busbar connection, covers ⑮, ⑯ and ⑱ can be mounted

Accessories and spare parts, see pages 3/75 to 3/124.

Switching Devices – Contactors and Contactor Assemblies – for Switching Motors

Power Contactors for Switching Motors

General data

3RT106 and 3RT146 contactors · Size S10 with mountable accessories

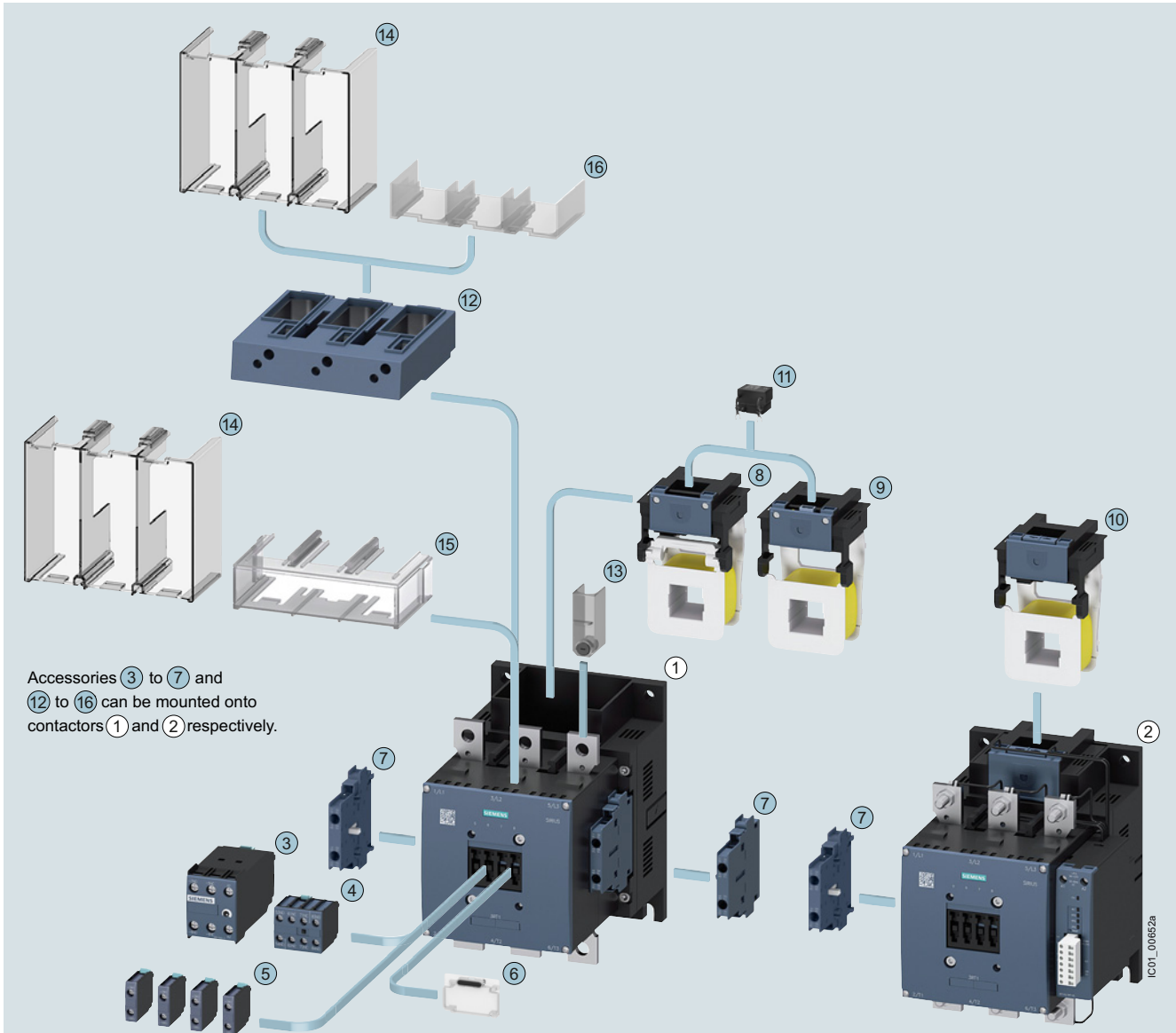

Accessories ③ to ⑦ and ⑫ to ⑯ can be mounted onto contactors ① and ② respectively.

- ① 3RT106 and 3RT146 air-break contactors, size S10 (version without withdrawable coil)
- ② 3RT106.-P and 3RT146.-P air-break contactors with solid-state operating mechanism and remaining lifetime indicator, size S10 (version with withdrawable coil and laterally mountable add-on module)

Can be mounted onto the front of contactors ① and ②

- ③ 3RT1926: Auxiliary switch, electronically delayed (ON-delay or OFF-delay or star-delta (wye-delta) starting)
- ④ 3RH192: 4-pole auxiliary switch
- ⑤ 3RH192: 1-pole auxiliary switch (max. four can be snapped on)
- ⑥ 3RT1926-4MA10: Cover, sealable

Can be mounted onto the side of contactors ① and ②

- ⑦ 3RH192: 2-pole auxiliary switch

Can be inserted in the top of contactors

- ⑧ 3RT1965-5A.3.: Withdrawable coil, standard operating mech.
- ⑨ 3RT1965-5N.3.: Withdrawable coil, solid-state operating mech.
- ⑩ 3RT1965-5P.3.: Withdrawable coil, solid-state operating mech. and remaining lifetime indicator

Can be plugged onto the top of contactor operating mechanisms ⑧ and ⑨

- ⑪ 3RT1956-1C: Surge suppressor (RC element)

Can be mounted at the top or bottom on busbars or box terminals of contactors ① and ②

- ⑫ 3RT1966-4G: Box terminal block
- ⑬ 3TX6546-3B: Terminal cover (can be screwed on), covers one busbar connection
- ⑭ 3RT1966-4EA1: Terminal cover for busbar connection and on box terminal
- ⑮ 3RT1966-4EA3: Terminal cover for busbar connection
- ⑯ 3RT1966-4EA2: Terminal cover on box terminal

Accessories and spare parts, see pages 3/75 to 3/124.

Switching Devices – Contactors and Contactor Assemblies – for Switching Motors

Power Contactors for Switching Motors

General data

3RT126 vacuum contactors · Size S10 with mountable accessories

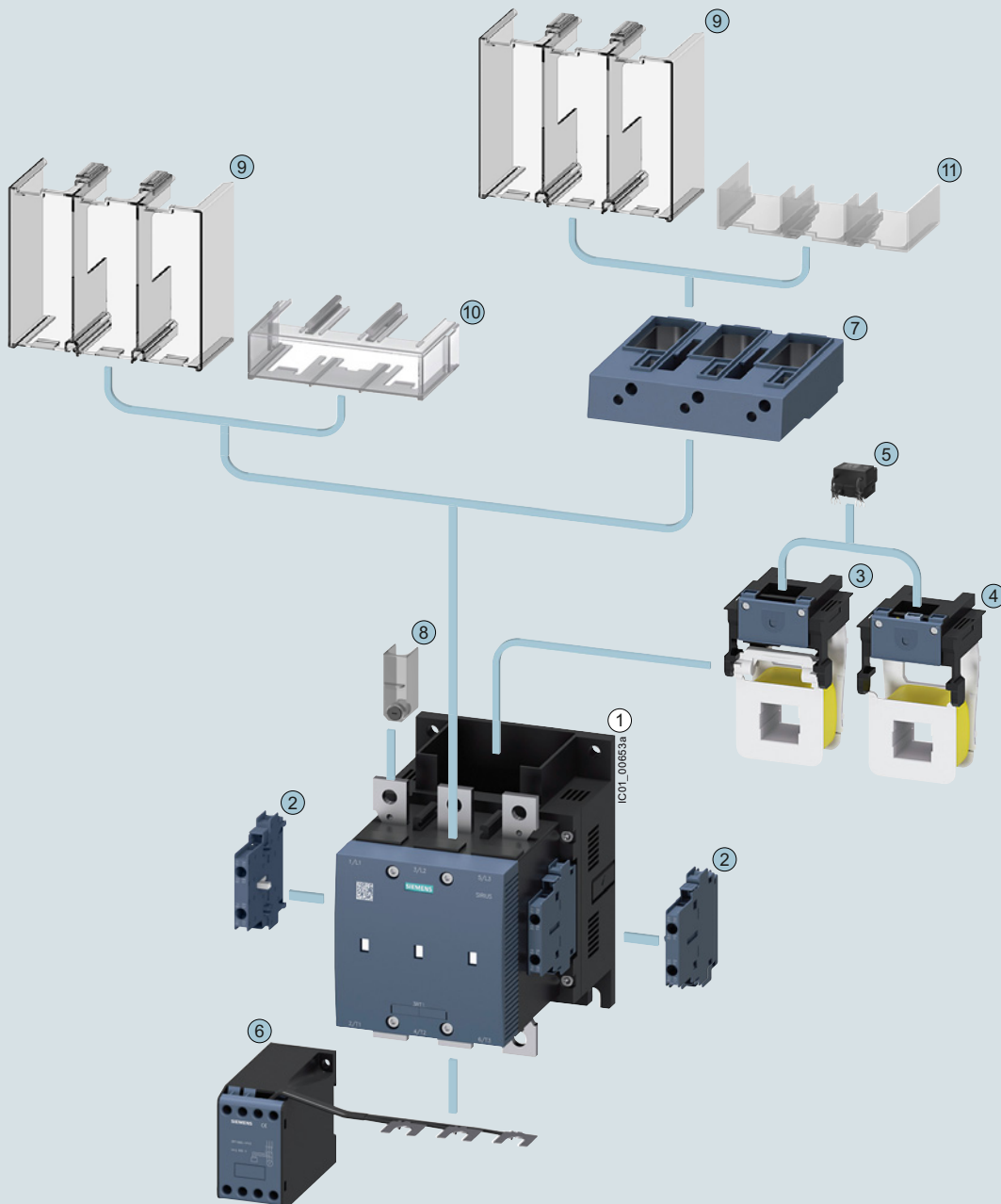

- ① 3RT126 vacuum contactor, size S10
(version without withdrawable coil)

Can be mounted onto side of contactor

- ② 3RH192: 2-pole auxiliary switch

Can be inserted in top of contactor

- ③ 3RT1966-5A.3.: Withdrawable coil, standard operating mechanism
④ 3RT1966-5N.3.: Withdrawable coil, solid-state operating mechanism

Can be plugged onto top of contactor operating mechanisms

- ⑤ 3RT1956-1C: Surge suppressor (RC element)

Can be mounted at bottom on busbars

- ⑥ 3RT1966-1PV.: Main current path surge suppression module

Can be mounted onto the top or bottom on busbars or box terminals

- ⑦ 3RT1966-4G: Box terminal block
⑧ 3TX6546-3B: Terminal cover (can be screwed on), covers one busbar connection
⑨ 3RT1966-4EA1: Terminal cover for busbar connection and on box terminal
⑩ 3RT1966-4EA3: Terminal cover for busbar connection
⑪ 3RT1966-4EA2: Terminal cover on box terminal

Accessories and spare parts, see pages 3/75 to 3/124 and 3/137 to 3/140.

Switching Devices – Contactors and Contactor Assemblies – for Switching Motors

Power Contactors for Switching Motors

General data

3RT107 and 3RT147 contactors - Size S12 with mountable accessories

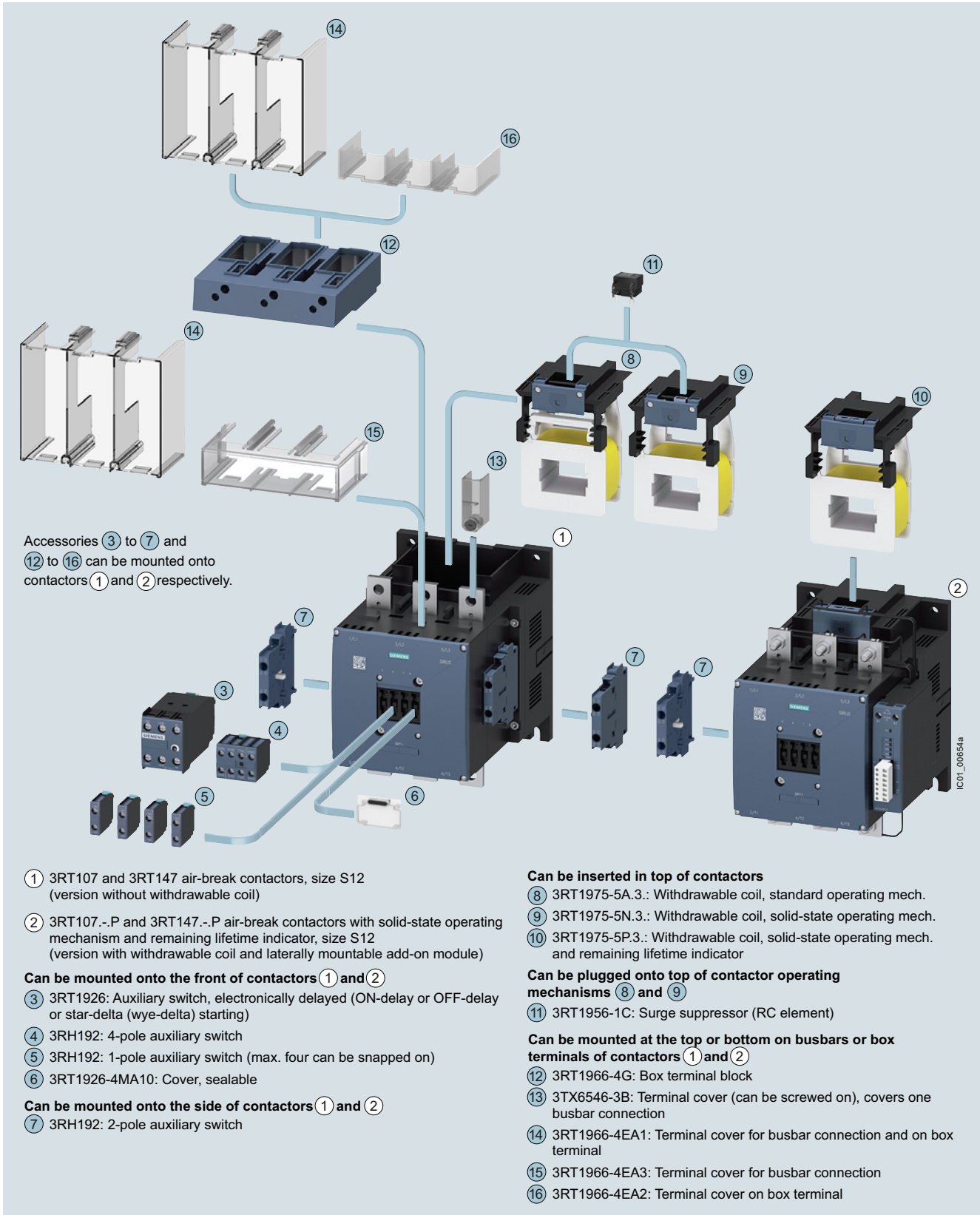

Accessories and spare parts, see pages 3/75 to 3/124.

Switching Devices – Contactors and Contactor Assemblies – for Switching Motors

Power Contactors for Switching Motors

General data

3RT127 vacuum contactors · Size S12 with mountable accessories

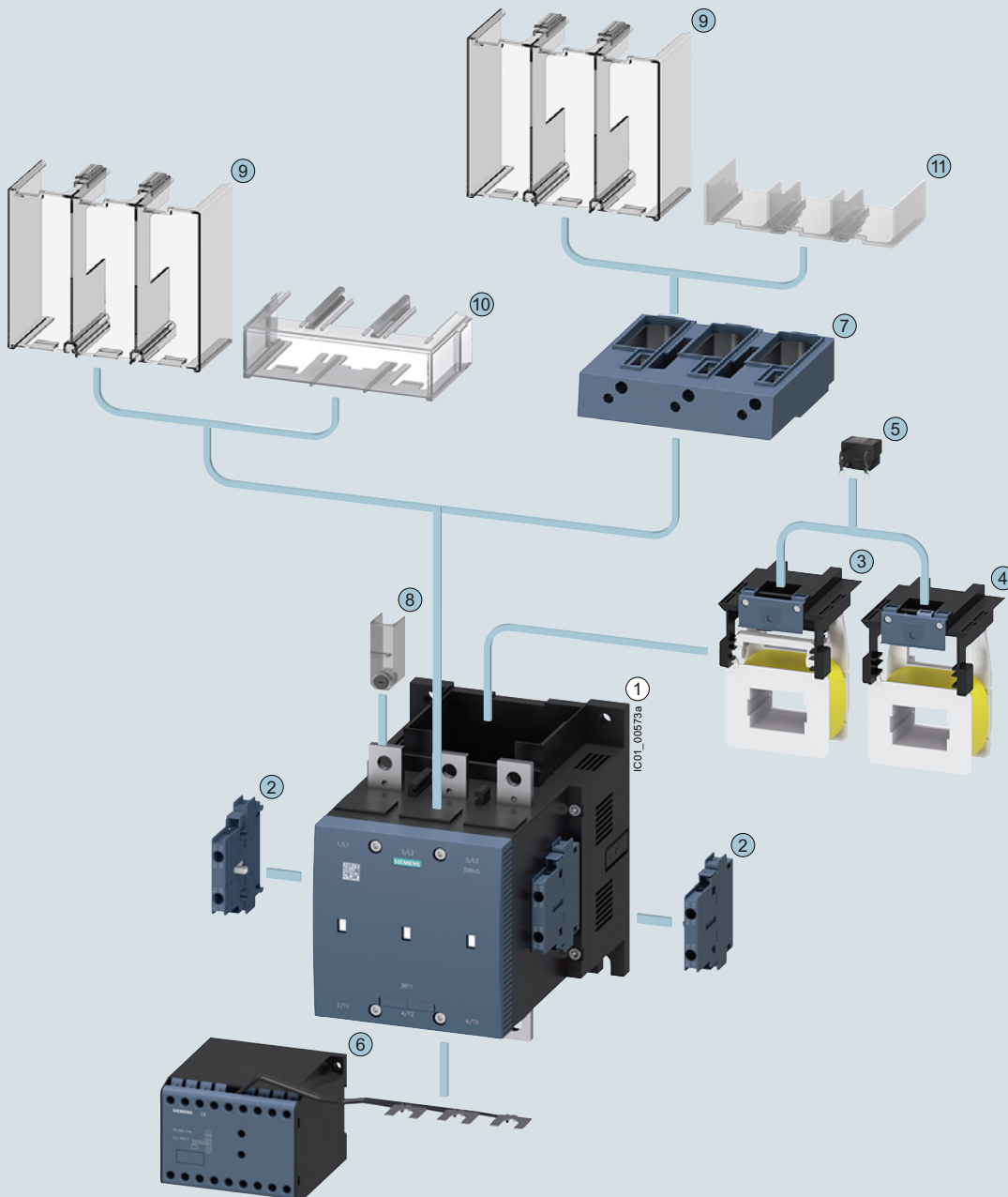

- ① 3RT127 Vacuum contactor, size S12
(version without withdrawable coil)

Can be mounted onto the side of contactor

- ② 3RH192: 2-pole auxiliary switch

Can be inserted in top of contactors

- ③ 3RT1975-5A.3.: Withdrawable coil, standard operating mechanism
④ 3RT1975-5N.3.: Withdrawable coil, solid-state operating mechanism

Can be plugged onto the top of contactor operating mechanisms

- ⑤ 3RT1956-1C: Surge suppressor (RC element)

Can be mounted at bottom on busbars

- ⑥ 3RT1966-1PV.: Main current path surge suppression module

Can be mounted at the top or bottom on busbars or box terminals

- ⑦ 3RT1966-4G: Box terminal block
⑧ 3TX6546-3B: Terminal cover (can be screwed on), covers one busbar connection
⑨ 3RT1956-4EA1: Terminal cover for busbar connection and on box terminal
⑩ 3RT1966-4EA3: Terminal cover for busbar connection
⑪ 3RT1966-4EA2: Terminal cover on box terminal

Accessories and spare parts, see pages 3/75 to 3/124 and 3/137 to 3/140.

Switching Devices – Contactors and Contactor Assemblies – for Switching Motors

Power Contactors for Switching Motors

SIRIUS 3RT contactors, 3-pole up to 250 kW

Overview

Version	Size	Ratings of three-phase motors at 50 Hz and 400 V kW	Connection methods		Type	Page
			Screw terminals	Spring-loaded terminals		
Power contactors for switching motors						
AC operation						
Basic unit	S00	3 ... 7.5	✓	✓	3RT201.-A.0.	3/54
• With permanently mounted auxiliary switch			✓	✓	3RT201.-AP04-3MA0	3/54
• With permanently mounted auxiliary switch and varistor plugged into the front			✓	✓	3RT201.-CP04-3MA0	3/54
Basic unit	S0	4 ... 18.5	✓	✓	3RT202.-A.00	3/55
• With removable auxiliary switch			✓	✓	3RT202.-A.04	3/56
• With permanently mounted auxiliary switch and varistor plugged in			✓	✓	3RT202.-CL24-3MA0	3/56
Basic unit	S2	18.5 ... 37	✓	✓	3RT203.-A.00	3/57
• With removable auxiliary switch			✓	--	3RT203.-1A.04	3/57
• With permanently mounted auxiliary switch and integrated coil circuit			✓	✓	3RT203.-CL24-3MA0	3/57
Basic unit	S3	37 ... 55	✓	✓	3RT20.-A.00	3/58
• With removable auxiliary switch			✓	--	3RT204.-1A.04	3/58
• With permanently mounted auxiliary switch and integrated coil circuit			✓	--	3RT204.-1CL24-3MA0	3/58
DC operation						
Basic unit	S00	3 ... 7.5	✓	✓	3RT201.-B.4.	3/59
• With integrated coil circuit			✓	✓	3RT201.-B4.	3/59
• With permanently mounted auxiliary switch			✓	✓	3RT201.-BB44-3MA0	3/60
• With permanently mounted auxiliary switch and integrated coil circuit			✓	✓	3RT201.-FB44-3MA0	3/60
• With voltage tap-off			✓	✓	3RT201.-BB4.-0CC0	3/60
Basic unit	S0	4 ... 18.5	✓	✓	3RT202.-B.40	3/63
• With coil circuit plugged into front			✓	✓	3RT202.-B40	3/63
• With removable auxiliary switch			✓	✓	3RT202.-BB44	3/63
• With permanently mounted auxiliary switch and integrated coil circuit			✓	✓	3RT202.-B44-3MA0	3/64
• With voltage tap-off			✓	✓	3RT202.-BB40-0CC0	3/64
DC operation for direct control by PLC (coupling relays)						
Basic unit	S00	3 ... 5.5	✓	✓	3RT201.-B4.	3/61
Basic unit with integrated coil circuit	S00	3 ... 5.5	✓	✓	3RT201.-B4.	3/61, 3/62
	S0	4 ... 15	✓	✓	3RT202.-KB40	3/65
	S2	18.5 ... 37	✓	✓	3RT203.-KB40	3/66
	S3	37 and 45	✓	✓	3RT204.-KB40	3/66
AC/DC operation (50/60 Hz AC or DC)						
Basic unit with integrated coil circuit	S0	5.5 ... 18.5	✓	✓	3RT202.-N.30	3/67
Basic unit with integrated coil circuit	S2	18.5 ... 37	✓	✓	3RT203.-N.30	3/68
• With removable auxiliary switch			✓	--	3RT203.-1N.34	3/68
• With permanently mounted auxiliary switch			✓	✓	3RT203.-NB34-3MA0	3/68
• With voltage tap-off			✓	✓	3RT203.-NB30-0CC0	3/68
Basic unit with integrated coil circuit	S3	37 ... 55	✓	✓	3RT204.-N.30	3/69
• With removable auxiliary switch			✓	--	3RT204.-1N.34	3/69
• With permanently mounted auxiliary switch			✓	✓	3RT204.-NB34-3MA0	3/69
• With voltage tap-off			✓	✓	3RT204.-NB30-0CC0	3/69
Basic unit with integrated coil circuit	S6 ... S12	55 ... 250	✓ ¹⁾	✓	3RT10...-A.36	3/70
• Standard operating mechanism with economy circuit for AC and DC operation						
• Solid-state operating mechanism with the option of control via a separate 24 V DC control signal input						
- Fail-safe control signal input for safety-related applications up to SIL CL 3	S6 ... S12	55 ... 250	✓ ¹⁾	--	3RT10...-S.36	3/71
- Standard control signal input			✓ ¹⁾	✓	3RT10...-N.36	3/72
- Standard control signal input, with remaining lifetime indicator (RLT)			✓ ¹⁾	--	3RT10...-P.35	3/72

-- Version not possible

✓ Version possible

¹⁾ Connection method:

- Main circuit: Busbar connection (optionally with box terminals),
- Auxiliary/control circuit: Screw terminals or spring-loaded terminals.

Switching Devices – Contactors and Contactor Assemblies – for Switching Motors

Power Contactors for Switching Motors

SIRIUS 3RT contactors, 3-pole up to 250 kW



Contactors with screw terminals: 3RT2 (sizes S00 to S3) and 3RT1 (sizes S6 to S12)

3RT contactors, sizes S00 to S12

Our power range:

- Contactors for switching motors:
 - Size S00: 3RT201 up to 7.5 kW
 - Size S0: 3RT202 up to 18.5 kW
 - Size S2: 3RT203 up to 37 kW
 - Size S3: 3RT204 up to 55 kW
 - Sizes S6 to S12: 3RT10 up to 250 kW
- For vacuum contactors for switching motors, [see page 3/125 onwards](#):
 - Sizes S10 and S12: 3RT12 up to 250 kW
 - Size 14: 3TF6 up to 450 kW

Standards

IEC/EN 60947-1, IEC/EN 60947-4-1, IEC/EN 60947-5-1 (auxiliary switches)

Ambient conditions

If the devices are used in ambient conditions which deviate from common industrial conditions (IEC 60721-3-3 "Stationary Use, Weather-Protected"), information must be obtained about possible restrictions with regard to the reliability and endurance of the device and possible protective measures.

In this case contact our Technical Support:

<https://support.industry.siemens.com/My/ww/en/requests>.

Auxiliary contact complement

- Size S00: an auxiliary contact is integrated in the basic device.
- Sizes S0 to S3: the basic units contain two integrated auxiliary contacts (1 NO + 1 NC). All basic units, with the exception of coupling relays in sizes S00 and S0, can be expanded using auxiliary switches, [see page 3/87 for the permitted selection of auxiliary switches](#).
- Sizes S6 to S12: These contactors are supplied with two laterally mounted auxiliary switches. The fitting of auxiliary switches is possible on the front and on the side (the 3RT12 vacuum contactor is an exception: only lateral fitting of auxiliary switches is possible here).

For detailed information about the fitting of auxiliary switches, [see pages 3/87 to 3/92](#).

Contact reliability

If voltages ≤ 110 V and currents ≤ 100 mA are to be switched, the auxiliary contacts of the 3RT contactors or 3RH contactor relays should be used as they guarantee a high level of contact reliability.

These auxiliary contacts are particularly suitable for solid-state circuits with currents ≥ 1 mA at a voltage ≥ 17 V.

Switching Devices – Contactors and Contactor Assemblies – for Switching Motors

Power Contactors for Switching Motors

SIRIUS 3RT contactors, 3-pole up to 250 kW

Connection methods

Main circuit

- Sizes S00 and S0: screw or spring-loaded terminals, spring-loaded terminals with convenient plug-in design for device connectors
- Sizes S2 and S3: screw terminals with box terminal; direct connection to the connecting bar possible with cable lugs for S3 when the box terminal is removed.
- Sizes S6 to S12: screw terminals with connecting bars that the cables can be connected to using either cable lugs or flexible or rigid busbars. Alternatively, box terminals are available as accessories.

Auxiliary/control circuit

- Sizes S00 to S12: Screw or spring-loaded terminals

Electromagnetic compatibility (EMC)

The 3RT contactors fulfill the requirements for environment category A.

Note:

When the contactors are used in an environment with frequency converters, the configuration notes in the Equipment Manual must be observed, see "More information", page 3/22.

Short-circuit protection

Short-circuit protection of contactors without overload relays, see "Technical specifications":

- For 3RT2 contactors, see pages 3/27, 3/33, 3/37 and 3/42
- For 3RT1 contactors, see page 3/47

For short-circuit protection of contactors with overload relays or of load feeders, refer to the Configuration Manuals, see "More information" on page 3/22.

For fuseless assembly of motor feeders consisting of 3RV2 motor starter protector and 3RT2 contactor, selection aids are available, see "SIRIUS 3RA2 load feeders", page 8/4 onwards.

Motor protection

3RT2 contactors

For protection against overload, 3RU2 thermal overload relays (see page 7/92 onwards) or 3RB3 electronic overload relays (see page 7/105 onwards) can be mounted onto the 3RT2 contactors.

3RT1 contactors

For protection against overload, 3RB2 electronic overload relays (see page 7/117 onwards) can be mounted onto the 3RT1 contactors.

Plant and application monitoring

For monitoring and measuring in the application, 3RR2 monitoring relays can be mounted onto the 3RT2 contactors (see page 10/51).

Ratings of three-phase motors

The quoted rating (in kW) refers to the output power on the motor shaft (according to the nameplate).

The power rating specifications of the contactors in kW (in accordance with IEC 60947-4-1, Table G) are guide values for 4-pole standard motors at 50 Hz AC and specified voltage (e.g. 400 V). The actual starting and rated data of the motor to be switched must be considered when selecting the units. The motor current, motor protection device and the permissible contactor current according to the utilization category must be aligned with each other.

Surge suppression

3RT contactors supplied without a coil circuit can be retrofitted with RC elements, varistors, diodes or diode assemblies (assembly of diode and Zener diode for short break times) for damping opening surges in the coil, see page 3/102 onwards.

- Size S00: the surge suppressors are plugged onto the front of the contactors here. Space is provided for them next to a snap-on auxiliary switch.
- Sizes S0 to S3: the surge suppressors can be plugged onto the front of the devices. In the case of size S3 contactors, surge suppressors can only be used as from product version E03.
- Sizes S6 to S12: Exchangeable operating mechanisms with integrated coil circuit (varistor)

Note:

The OFF-delay of the NO contact and the ON-delay of the NC contact are increased if the contactor coils are attenuated against voltage peaks (for details, see the relevant manual → "More information", page 3/22).

Contactors with voltage tap-off

3RT2 contactors

The size S00 to S3 contactors with voltage tap-off are special versions for mounting the SIRIUS 3RA27 function modules for connection to the control system via IO-Link or AS-Interface (see page 3/79 onwards).

Without a function module, these contactors can be used like the standard versions.

For more information on IO-Link and AS-Interface, see "Industrial Communication", page 2/1 onwards.

Operating mechanism types

3RT2 contactors

3RT2 contactors are available as standard versions with AC or DC operating mechanisms or as versions with a wide-range solid-state operating mechanism and a universal actuating voltage (AC or DC operation possible).

DC coupling contactors with reduced power consumption are also ideally suited for connection to the controller.

With an operating range from 0.8 to $1.1 \times U_s$, control typically takes place via the control supply voltage connection A1 - A2.

3RT1 contactors

The following control and/or operating mechanism versions are available in sizes S6 to S12:

- Standard operating mechanism with economy circuit for AC and DC operation (switchover from closing coil to holding coil)
- Solid-state operating mechanisms
Overvoltage damping of the operating mechanism coil is already integrated in the electronics for contactors with solid-state operating mechanisms. The operating mechanisms are powered via a supply voltage with an operating range from 0.8 to $1.1 \times U_s$, optionally also controlled depending on the chosen mode of operation. Alternatively, control is via the separate 24 V DC control signal input. Various rated voltage ranges for AC/DC control are available.

The following versions are available:

- With two operating modes: Direct control or via PLC input
- As above, but additionally with remaining lifetime indicator (RLT)
- With fail-safe PLC input for simplification of safety applications (without mode of operation selection)

Switching Devices – Contactors and Contactor Assemblies – for Switching Motors

Power Contactors for Switching Motors

SIRIUS 3RT contactors, 3-pole up to 250 kW

Solenoid coils/drive units

3RT2 contactors

Coil replacement is possible for sizes S0 to S3.

3RT1 contactors

The operating mechanisms for 3RT10...-A/-N/-P contactors are removable and can be replaced simply by unlocking and pulling them out.

NOTICE: Removal or changing of the operating mechanism is not permitted for 3RT10...-S contactors with fail-safe control.

Contactors in safety-related applications

Contactors are a significant part of safety-related applications. They are generally the actuators that perform the switching operation leading to the safe disconnection of the corresponding application or system.

Contactors with mirror contacts according to IEC 60947-4-1 are generally required for use in safety-related applications. Most of our contactors meet this requirement; a corresponding note can be found in the technical product data sheet.

Contactors with increased tamper protection

Increased tamper protection is ensured either by using our contactor versions with factory-installed, permanently mounted auxiliary switches protected against mechanical external actuation (e.g. 3RT2...-3MA0 or 3RT1...-3PA0 contactors), or by using the 3RT2916-4MA10 or 3RT1926-4MA10 sealable cover as an accessory (see page 3/117).

Connection of contactors to fail-safe control modules

While contactors with smaller power ratings can be connected directly to the outputs of fail-safe controllers, implementing safety-related applications with standard contactors with higher power is much more complicated and elaborate because of the necessary coupling links. Due to their fail-safe control input, the special versions in sizes S6 to S12 (3RT10...-S) provide a much simpler way of doing this.

For more information on safety systems, see page 11/1 onwards.

Example for SIL 2 and SIL 3 / PL_e application - previously:

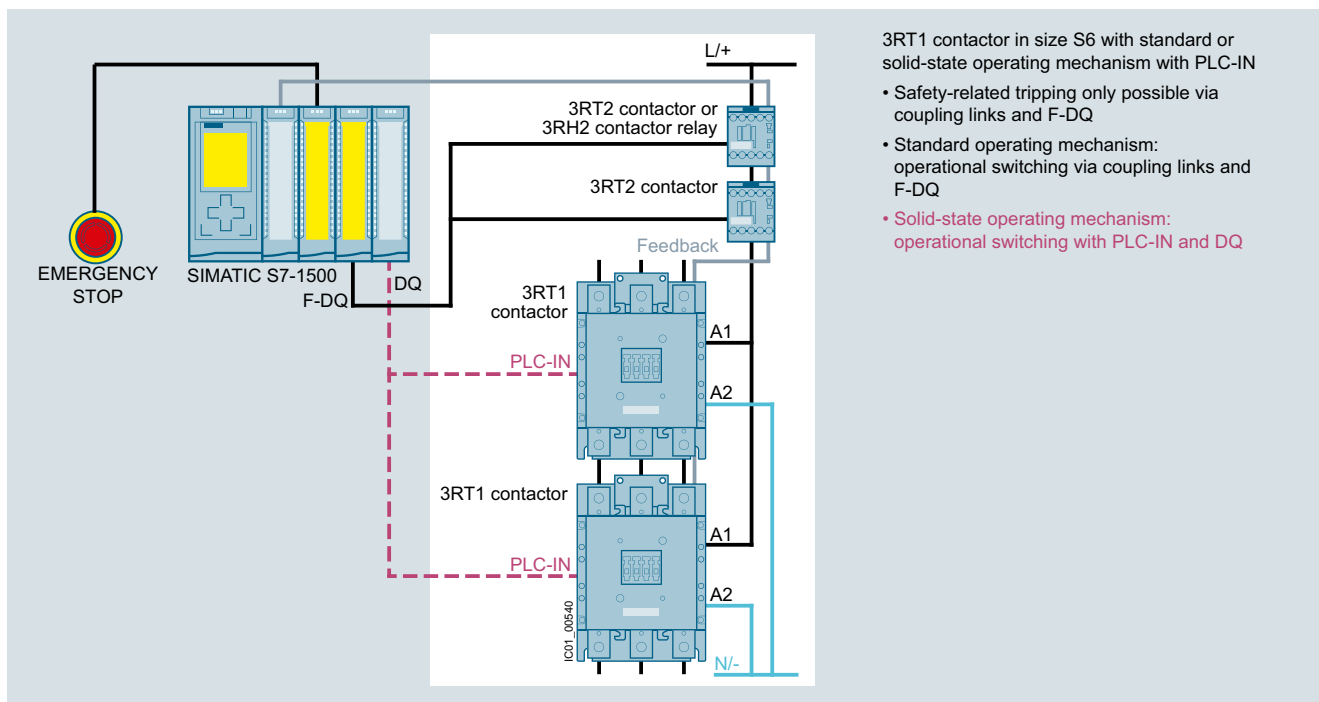

Application with safety-related disconnection with standard contactors

Switching Devices – Contactors and Contactor Assemblies – for Switching Motors

Power Contactors for Switching Motors

SIRIUS 3RT contactors, 3-pole up to 250 kW

Example for SIL 3 / PL e (left-hand side) and SIL 2 / PL c (right-hand side) application - new:

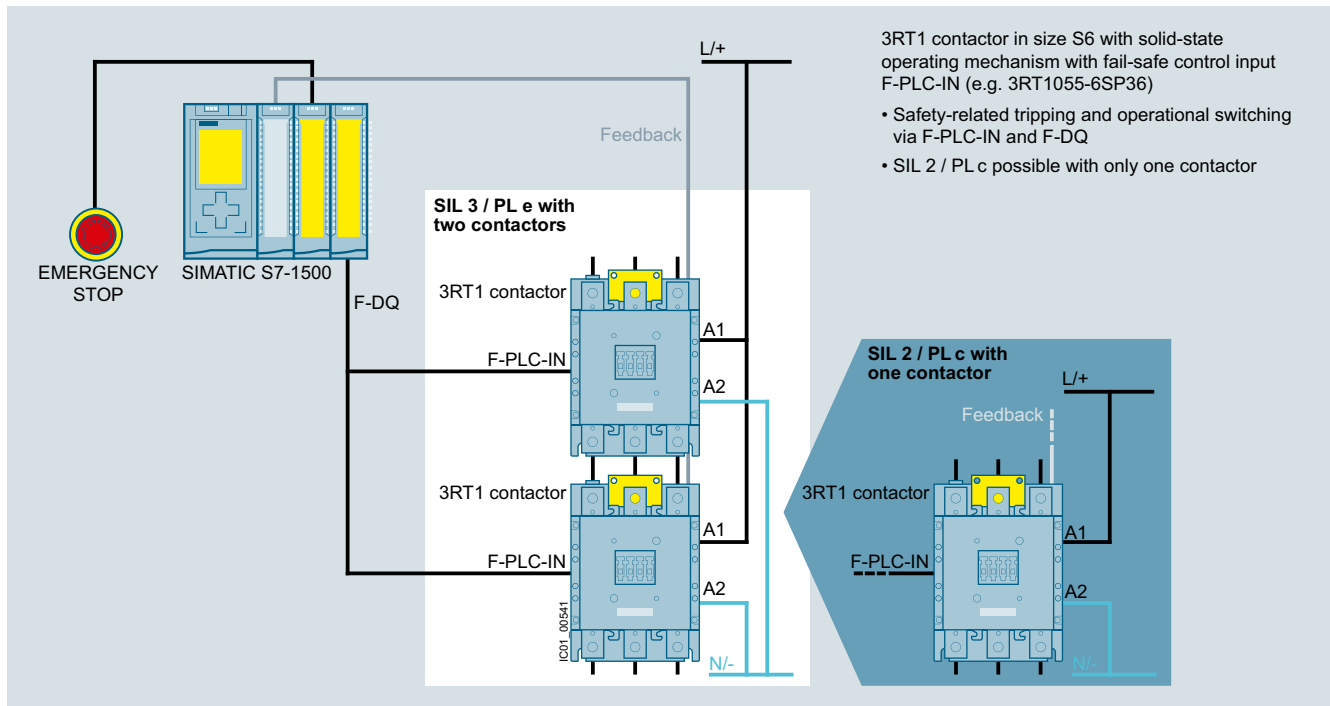

Application with safety-related disconnection with contactors with fail-safe control

Contactors for special applications

- SIRIUS 3RT.4 contactors for resistive loads (AC-1), 3-pole, [see page 4/6 onwards](#)
- SIRIUS 3RT20 and 3RT10 contactors with an extended application range, 3-pole (for rail applications), [see page 4/49 onwards](#)

Article No. scheme

Product versions	Article number
SIRIUS power contactors	3RT2 <input type="checkbox"/> <input type="checkbox"/> <input type="checkbox"/> - <input type="checkbox"/> <input type="checkbox"/> <input type="checkbox"/> <input type="checkbox"/> - <input type="checkbox"/> <input type="checkbox"/> <input type="checkbox"/>
Device type	e.g. 0 = 3-pole motor contactor <input type="checkbox"/>
Size of the contactor	e.g. 4 = S3 <input type="checkbox"/>
Rating dependent on size	e.g. 5 = 37 kW for S3 <input type="checkbox"/>
Type of electrical connection	e.g. 1 = Screw terminals (main and auxiliary circuits) <input type="checkbox"/>
Operating range/solenoid coil circuit	e.g. A = AC standard/without coil circuit <input type="checkbox"/>
Rated control supply voltage	e.g. P0 = 230 V AC, 50 Hz <input type="checkbox"/> <input type="checkbox"/>
Auxiliary switches	e.g. 0 = for S3: 1 NO + 1 NC integrated <input type="checkbox"/>
Special version	<input type="checkbox"/> <input type="checkbox"/> <input type="checkbox"/>
Example	3RT2 0 4 5 - 1 A P 0 0

Note:

The Article No. scheme shows an overview of product versions for better understanding of the logic behind the article numbers.

For your orders, please use the article numbers quoted in the selection and ordering data.

Switching Devices – Contactors and Contactor Assemblies – for Switching Motors

Power Contactors for Switching Motors

SIRIUS 3RT contactors, 3-pole up to 250 kW

Technical specifications

More information

Technical specifications, see
<https://support.industry.siemens.com/cs/ww/en/ps/16134/td>
 FAQs, see <https://support.industry.siemens.com/cs/ww/en/ps/16134/faq>

System Manual "SIRIUS – System Overview", see
<https://support.industry.siemens.com/cs/ww/en/view/60311318>
 Equipment Manual "SIRIUS – SIRIUS 3RT Contactors/Contactor Assemblies", see <https://support.industry.siemens.com/cs/ww/en/view/60306557>
 Application Manual "SIRIUS Controls with IE3/IE4 motors", see
<https://support.industry.siemens.com/cs/ww/en/view/94770820>
 Configuration Manual "Load Feeders – Configuring the SIRIUS Modular System", see <https://support.industry.siemens.com/cs/ww/en/view/39714188>
 Configuration Manual "Configuring SIRIUS Innovations UL", see
<https://support.industry.siemens.com/cs/ww/en/view/53433538>

Type	Contactors			
	3RT2		S3	3RT1
Size	S00 to S2		S3	S6 to S12
Rated data of the auxiliary contacts				
According to IEC/EN 60947-5-1				
Data apply to integrated auxiliary contacts and conventional contacts in the auxiliary switches				
Rated insulation voltage U_i (pollution degree 3)	V	690	1 000 (3RT20...0CC0: 690)	--
• For laterally mountable auxiliary switches	V	690	690	500
• For front auxiliary switches	V	690	690	690
Conventional thermal current I_{th} = rated operational current $I_e/AC-12$	A	10		
AC load				
Rated operational current $I_e/AC-15/AC-14$				
• At rated operational voltage U_e	Up to 230 V	A	10 ¹⁾	6
	400 V	A	3	6
	500 V	A	2	3
	690 V	A	1	2
				1 ²⁾
DC load				
Rated operational current $I_e/DC-12$				
• At rated operational voltage U_e	24 V	A	10	10
	60 V	A	6	6
	110 V	A	3	3
	125 V	A	2	2
	220 V	A	1	1
	440 V	A	0.3	0.3
	600 V	A	0.15	0.15 ²⁾
Rated operational current $I_e/DC-13$				
• At rated operational voltage U_e	24 V	A	10 ¹⁾	10 ³⁾
	60 V	A	2	2
	110 V	A	1	1
	125 V	A	0.9	0.9
	220 V	A	0.3	0.3
	440 V	A	0.14	0.14
	600 V	A	0.1	0.15 ²⁾
Contact reliability at 17 V, 1 mA Acc. to IEC/EN 60947-5-4	Frequency of contact faults < 10 ⁻⁸ i.e. < 1 fault per 100 million operating cycles			

¹⁾ 3RH22, 3RH29, 3RT2...-...4, 3RT2...-...6: $I_e = 6$ A at AC-15/AC-14 and DC-13.

²⁾ With laterally mountable auxiliary switches, only the currents for rated operational voltages up to 500 V apply.

³⁾ For laterally mountable auxiliary switches, DC-13/at 24 V: Max. 6 A.

Switching Devices – Contactors and Contactor Assemblies – for Switching Motors

Power Contactors for Switching Motors

SIRIUS 3RT contactors, 3-pole up to 250 kW

Type
Size

3RT contactors
S00 to S12

Contact endurance of the auxiliary contacts

It is assumed that the operating mechanisms are switched randomly, i.e. not synchronized with the phase angle of the supply system.

The contact endurance is mainly dependent on the breaking current.

Sizes S00 to S3

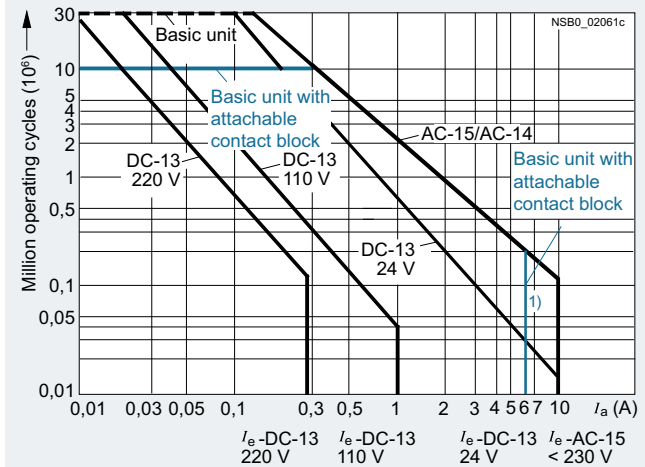

Sizes S6 to S12

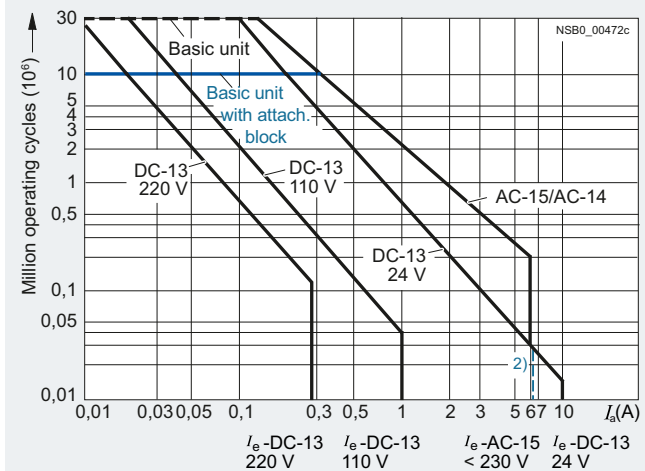

¹⁾ 3RH22, 3RH29, 3RT2...-...4, 3RT2...-...6: $I_e = 6$ A at AC-15/AC-14 and DC-13, 3RT2.4: $I_e = 6$ A at AC-15/AC-14.

²⁾ For laterally mountable auxiliary switches, DC-13/at 24 V: Max. 6 A.

³⁾ With laterally mountable auxiliary switches, only the currents for rated operational voltages up to 500 V apply.

Switching Devices – Contactors and Contactor Assemblies – for Switching Motors

Power Contactors for Switching Motors

SIRIUS 3RT contactors, 3-pole up to 250 kW

Type	3RT2 contactors
Size	S00 and S0

Contact endurance of the main contacts

The characteristic curves show the contact endurance of the contactors when switching resistive and inductive AC loads (AC-1/AC-3) depending on the breaking current and rated operational voltage. It is assumed that the operating mechanisms are switched randomly, i.e. not synchronized with the phase angle of the supply system.

The rated operational current I_e complies with utilization category AC-4 (breaking 6 times the rated operational current) and is intended for a contact endurance of approximately 200 000 operating cycles.

If a shorter contact endurance is sufficient, the rated operational current $I_e/AC-4$ can be increased.

If the contacts are used for mixed operation, i.e. normal switching (breaking the rated operational current according to utilization category AC-3) in combination with intermittent inching (breaking several times the rated operational current according to utilization category AC-4), the contact endurance can be calculated approximately from the following equation:

$$X = \frac{A}{1 + \frac{C}{100} \left(\frac{A}{B} - 1 \right)}$$

Characters in the equation:

- X Contact endurance for mixed operation in operating cycles
- A Contact endurance for normal operation ($I_a = I_e$) in operating cycles
- B Contact endurance for inching ($I_a = \text{multiple of } I_e$) in operating cycles
- C Inching operations as a percentage of total switching operations

Size S00

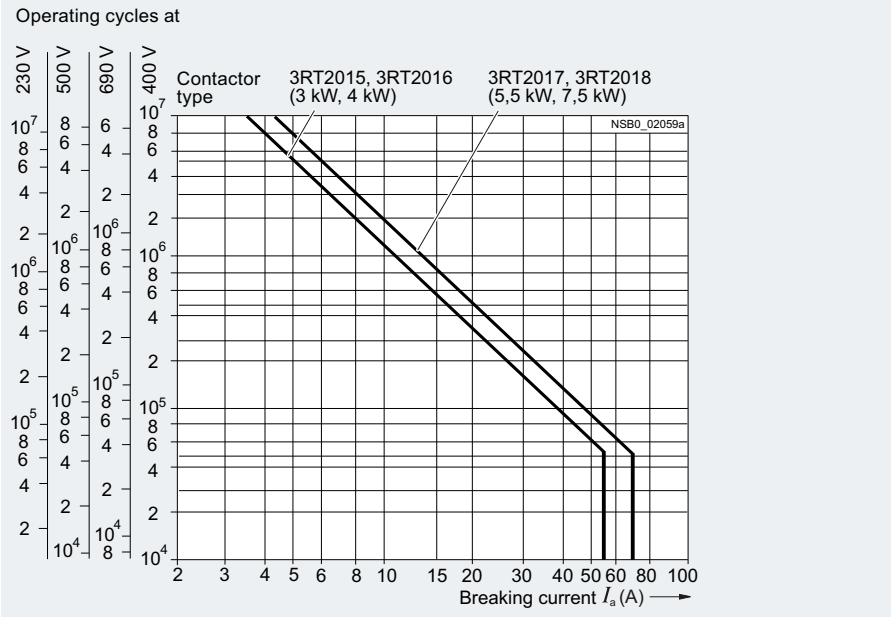

Size S0

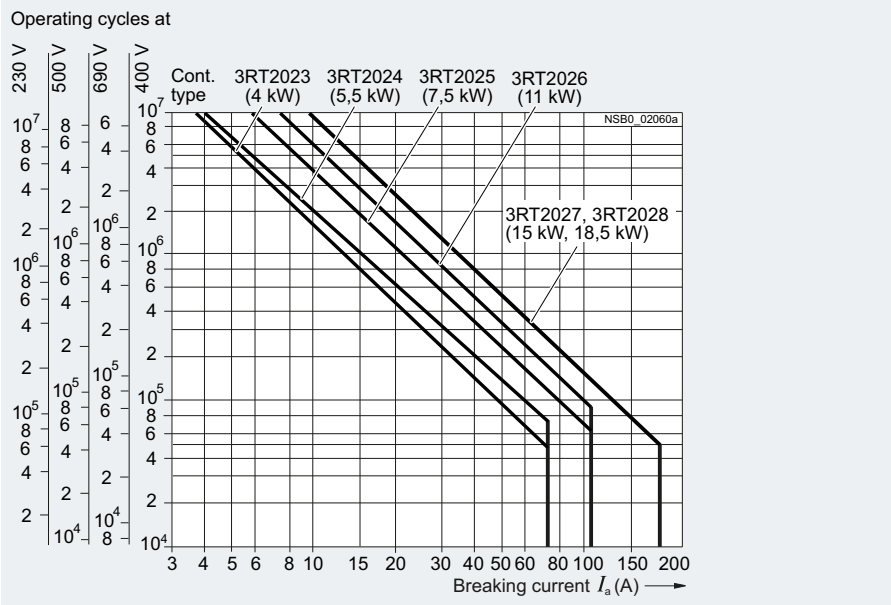

Switching Devices – Contactors and Contactor Assemblies – for Switching Motors

Power Contactors for Switching Motors

SIRIUS 3RT contactors, 3-pole up to 250 kW

Type **3RT contactors**
 Size **S2 to S12**

Contact endurance of main contacts
 (continued)

Size S2

Operating cycles at

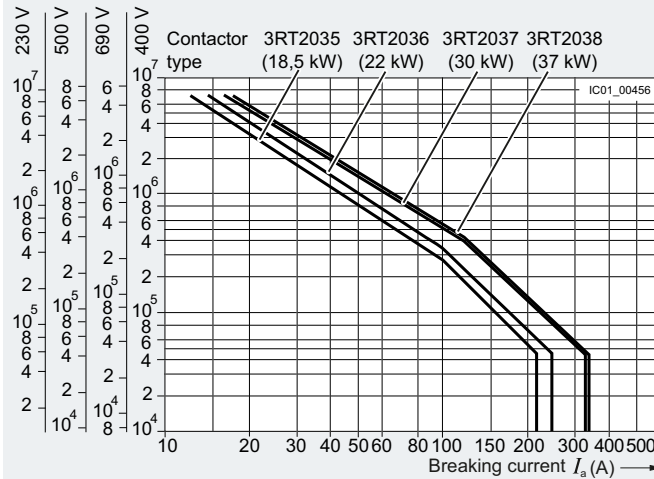

Size S3

Operating cycles at

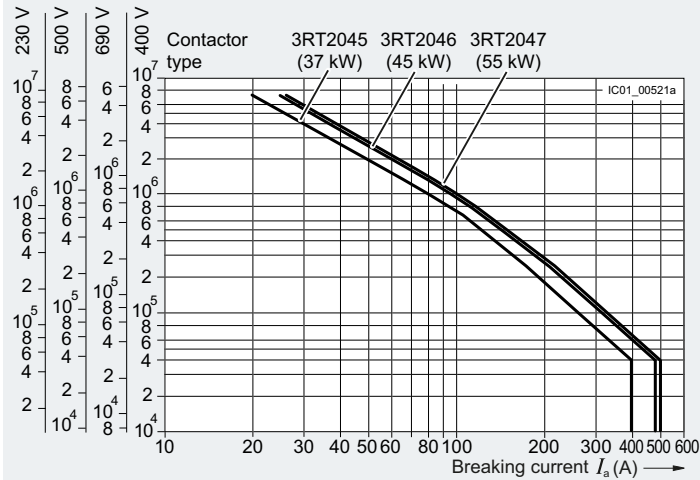

Sizes S6 to S12

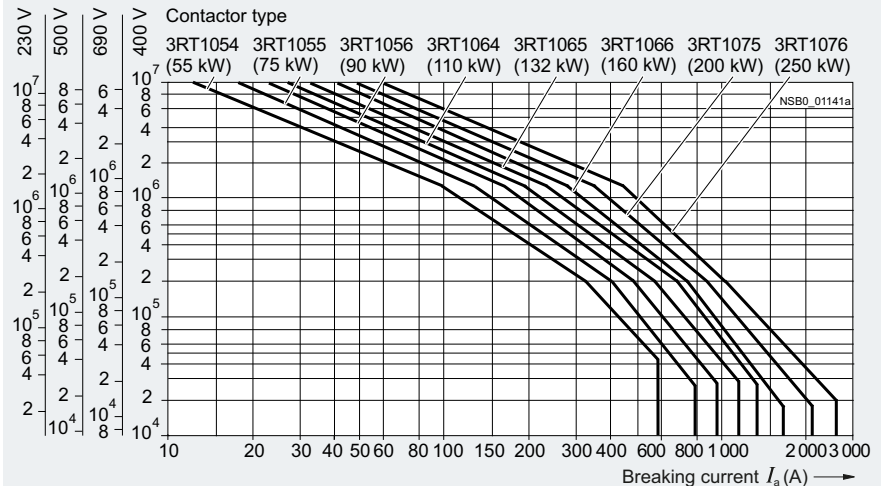

Operating cycles at



Switching Devices – Contactors and Contactor Assemblies – for Switching Motors

Power Contactors for Switching Motors

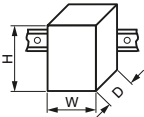
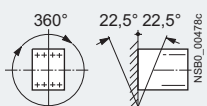
SIRIUS 3RT contactors, 3-pole up to 250 kW

		Contactors	
		3RT2015, 3RT2016	3RT2017, 3RT2018
Type		S00	
Size			
General data			
Dimensions (W x H x D)			
<ul style="list-style-type: none"> Basic unit <ul style="list-style-type: none"> Screw terminals Spring-loaded terminals Basic unit with mounted auxiliary switch <ul style="list-style-type: none"> Screw terminals Spring-loaded terminals Basic unit with mounted function module or solid-state time-delay auxiliary switch <ul style="list-style-type: none"> Screw terminals Spring-loaded terminals 		mm	45 x 58 x 73
		mm	45 x 70 x 73
		mm	45 x 58 x 117
		mm	45 x 70 x 121
		mm	45 x 58 x 147
		mm	45 x 70 x 147
Permissible mounting position			
The contactors are designed for operation on a vertical mounting surface.			
Upright mounting position		 Special version required	
Mechanical endurance			
Basic unit	Operating cycles	30 million	
- With mounted auxiliary switch	Operating cycles	10 million	
- With solid-state compatible auxiliary switch	Operating cycles	5 million	
Electrical endurance			
For contact endurance of the main contacts, see page 3/24.			
Rated insulation voltage U_i (pollution degree 3)		V	690
Rated impulse withstand voltage U_{imp}			
• Auxiliary circuit	kV	6	
• Main circuit	kV	6	
Protective separation between the coil and the main contacts acc. to IEC 60947-1, Appendix N		V	400
Mirror contacts			
A mirror contact is an auxiliary NC contact that cannot be closed simultaneously with an NO main contact.			
• 3RT2.1. (removable auxiliary switch)		Yes, this applies to both the basic unit as well as to between the basic unit and the mounted auxiliary switch according to IEC 60947-1, Appendix F	
• 3RH2919-.NF.. solid-state compatible auxiliary switches		No mirror contact for size S00	
Ambient temperature			
• During operation	°C	-25 ... +60	
• During storage	°C	-55 ... +80	
Degree of protection acc. to IEC 60529			
• On front	IP20 (screw terminals and spring-loaded terminals)		
• Connecting terminal	IP20 (screw terminals and spring-loaded terminals)		
Touch protection acc. to IEC 60529		Finger-safe (screw terminals and spring-loaded terminals)	
Shock resistance			
• Rectangular pulse	g/ms	6.7/5 and 4.2/10	7.3/5 and 4.7/10
	g/ms	6.7/5 and 4.2/10	7.3/5 and 4.7/10
• Sine pulse	g/ms	10.5/5 and 6.6/10	11.4/5 and 7.3/10
	g/ms	10.5/5 and 6.6/10	11.4/5 and 7.3/10

Switching Devices – Contactors and Contactor Assemblies – for Switching Motors

Power Contactors for Switching Motors

SIRIUS 3RT contactors, 3-pole up to 250 kW

Type	Contactors	
Size	3RT2015, 3RT2016	3RT2017, 3RT2018
S00		
Short-circuit protection		
Main circuit		
• Fuse links, operational class gG: LV HRC, type 3NA; DIAZED, type 5SB; NEOZED, type 5SE acc. to IEC/EN 60947-4-1		
- Type of coordination "1"	A	35
- Type of coordination "2"	A	20
- Weld-free (test conditions acc. to IEC 60947-4-1)	A	10
• Miniature circuit breaker (up to 230 V) with C characteristic Short-circuit current 1 kA, type of coordination "1"	A	10
Auxiliary circuit		
Short-circuit test according to IEC/EN 60947-5-1		
• With fuse links, operational class gG: DIAZED, type 5SB; NEOZED, type 5SE with short-circuit current $I_k = 1$ kA	A	10
• With 230 V miniature circuit breaker, C characteristic with short-circuit current $I_k = 400$ A	A	6
Short-circuit protection for contactors with overload relays		
See Configuration Manual for load feeders		
Short-circuit protection for fuseless load feeders		
See 3RA2 load feeders, page 8/4 onwards		
Control		
Solenoid coil operating range		
• AC operation	50 Hz 60 Hz	0.8 ... 1.1 x U_s 0.85 ... 1.1 x U_s
• DC operation	Up to 50 °C Up to 60 °C	0.8 ... 1.1 x U_s 0.85 ... 1.1 x U_s
Power consumption of the solenoid coils (for cold coil and 1.0 x U_s)		
• AC operation, 50/60 Hz, standard version		
- Closing	VA	27/24.3
- P.f.		0.8/0.75
- Closed	VA	4.2/3.3
- P.f.		0.25/0.25
• AC operation, 50 Hz, for USA/Canada		
- Closing	VA	26.4
- P.f. for closing		0.81
- Closed	VA	4.4
- P.f. for closed		0.24
• AC operation, 60 Hz, for USA/Canada		
- Closing	VA	31.7
- P.f. for closing		0.81
- Closed	VA	4.8
- P.f. for closed		0.25
• DC operation (closing = closed)	W	4
Permissible residual current of the electronics (with 0 signal)		
• AC operation		< 3 mA x (230 V/ U_s) ¹⁾
• DC operation		< 10 mA x (24 V/ U_s) ¹⁾
Operating times at 1.0 x U_s²⁾		
Total break time = Opening delay + Arcing time		
• AC operation		
- Closing delay	ms	9.5 ... 24
- Opening delay	ms	4 ... 14
• DC operation		
- Closing delay	ms	35 ... 50
- Opening delay	ms	7 ... 12
• Arcing time	ms	10 ... 15



¹⁾ The 3RT2916-1GA00 additional load module is recommended for higher residual currents, see page 3/119.



²⁾ The OFF-delay times of the NO contacts and the ON-delay times of the NC contacts increase if the contactor coils are attenuated against voltage peaks (suppression diode 6x to 10x; diode assembly 2x to 6x; suppression diode +1 to 5 ms; varistor +2 to 5 ms).

Switching Devices – Contactors and Contactor Assemblies – for Switching Motors

Power Contactors for Switching Motors

SIRIUS 3RT contactors, 3-pole up to 250 kW

Type		Coupling contactors		
Size		3RT201.-HB4.	3RT201.-JB4.	3RT201.-KB4.
Control		S00		
Solenoid coil operating range		0.7 ... 1.25 x U_s		
Power consumption of the solenoid coils (for cold coil) Closing = Closed		At U_s 24 V DC W 2.8		
Permissible residual current of the electronics (with 0 signal)		< 6 mA x (24 V/ U_s)		
Upright mounting position		On request		
Overvoltage configuration of the solenoid coil		No overvoltage damping 	Integrated diode 	Integrated suppressor diode 
Operating times				
• Closing delay				
- ON-delay NO		ms	35 ... 60	
- OFF-delay NC		ms	25 ... 40	
• Opening delay				
- ON-delay NO		ms	7 ... 20	38 ... 65
- OFF-delay NC		ms	20 ... 30	55 ... 75
- OFF-delay NC		ms		7 ... 20
- OFF-delay NC		ms		20 ... 30

Type		Coupling contactors		
Size		3RT201.-1MB4.-0KT0	3RT201.-1VB4.	3RT201.-1SB4.
Control		S00		
Solenoid coil operating range		0.85 ... 1.85 x U_s		
Power consumption of the solenoid coils (for cold coil) Closing = Closed		At U_s 24 V DC W 1.6		
Permissible residual current, upright mounting position		On request		
Overvoltage configuration of the solenoid coil		No overvoltage damping 	Integrated diode 	Integrated suppressor diode 
Operating times				
• Closing delay				
- ON-delay NO		ms	25 ... 90	
- OFF-delay NC		ms	15 ... 80	
• Opening delay				
- ON-delay NO		ms	5 ... 20	20 ... 80
- OFF-delay NC		ms	10 ... 30	30 ... 90
- OFF-delay NC		ms		5 ... 20
- OFF-delay NC		ms		10 ... 30

Switching Devices – Contactors and Contactor Assemblies – for Switching Motors

Power Contactors for Switching Motors

SIRIUS 3RT contactors, 3-pole up to 250 kW

Type Size	Contactors				
	3RT2015 S00	3RT2016	3RT2017	3RT2018	
Rated data of the main contacts					
Load rating with AC					
Utilization category AC-1, switching resistive loads					
• Rated operational currents I_e	At 40 °C up to 690 V At 60 °C up to 690 V	A A	18 16	22 20	
• Rated power for AC loads ¹⁾ P.f. = 0.95 (at 60 °C)	230 V 400 V 690 V	kW kW kW	6 10.5 18	7.5 13 22	
• Minimum cross-section in the main circuit for max. AC-1 rated value		mm ²	2.5	4	
Utilization categories AC-2 and AC-3					
• Rated operational currents I_e	Up to 400 V 440 V 500 V 690 V	A A A A	7 7 6 4.9	9 9 7.7 6.7	12 11 9.2 8.9
• Rated power for slipring or squirrel-cage motors at 50 and 60 Hz	At 230 V 400 V 690 V	kW kW kW	1.5 3 4	2.2 4 5.5	3 5.5 7.5
Thermal load capacity	10 s current	A	56	72	96
Power loss per conducting path	At $I_e/AC-3$	W	0.42	0.7	1.24
Utilization category AC-4 (at $I_a = 6 \times I_e$)²⁾					
• Maximum values					
- Rated operational current I_e	Up to 400 V	A	6.5	8.5	11.5
- Rated power for squirrel-cage motors with 50 Hz and 60 Hz	Up to 400 V	kW	3	4	5.5
• The following applies to a contact endurance of about 200 000 operating cycles:					
- Rated operational currents I_e	Up to 400 V 690 V	A A	2.6 1.8	4.1 3.3	5.5 4.4
- Rated power for squirrel-cage motors with 50 Hz and 60 Hz	At 230 V 400 V 690 V	kW kW kW	0.67 1.15 1.15	1.1 2 2.5	1.5 2.5 3.5

¹⁾ Industrial furnaces and electric heaters with resistance heating, etc. (increased power consumption on heating up has been taken into account).

²⁾ The data applies to 3RT2516 and 3RT2517 contactors (2 NO + 2 NC) up to a rated operational voltage of 400 V only.

Switching Devices – Contactors and Contactor Assemblies – for Switching Motors

Power Contactors for Switching Motors

SIRIUS 3RT contactors, 3-pole up to 250 kW

Type Size	Contactors		
	3RT2015 S00	3RT2016 to 3RT2018	
Rated data of the main contacts (continued)			
Load rating with DC			
Utilization category DC-1, switching resistive loads ($L/R \leq 1$ ms)			
• Rated operational currents I_e (at 60 °C)			
- 1 conducting path	Up to 24 V A	15	20
	60 V A	15	20
	110 V A	1.5	2.1
	220 V A	0.6	0.8
	440 V A	0.42	0.6
	600 V A	0.42	0.6
- 2 conducting paths in series	Up to 24 V A	15	20
	60 V A	15	20
	110 V A	8.4	12
	220 V A	1.2	1.6
	440 V A	0.6	0.8
	600 V A	0.5	0.7
- 3 conducting paths in series	Up to 24 V A	15	20
	60 V A	15	20
	110 V A	15	20
	220 V A	15	20
	440 V A	0.9	1.3
	600 V A	0.7	1
Utilization category DC-3/DC-5, shunt-wound and series-wound motors ($L/R \leq 15$ ms)			
• Rated operational currents I_e (at 60 °C)			
- 1 conducting path	Up to 24 V A	15	20
	60 V A	0.35	0.5
	110 V A	0.1	0.15
	220 V A	--	
	440 V A	--	
	600 V A	--	
- 2 conducting paths in series	Up to 24 V A	15	20
	60 V A	3.5	5
	110 V A	0.25	0.35
	220 V A	--	
	440 V A	--	
	600 V A	--	
- 3 conducting paths in series	Up to 24 V A	15	20
	60 V A	15	20
	110 V A	15	20
	220 V A	1.2	1.5
	440 V A	0.14	0.2
	600 V A	0.14	0.2
Switching frequency			
Switching frequency z in operating cycles/hour			
Contactors without overload relays			
• No-load switching frequency	AC/DC	1/h	10 000
• Switching frequency z during rated operation ¹⁾			
- $I_e/AC-1$	At 400 V	1/h	1 000
- $I_e/AC-2$	At 400 V	1/h	750
- $I_e/AC-3$	At 400 V	1/h	750
- $I_e/AC-4$	At 400 V	1/h	250
Contactors with overload relays			
• Mean value		1/h	15

¹⁾ Dependence of the switching frequency z' on the operational current I' and operational voltage U' :
 $z' = z \cdot (I_e/I') \cdot (U_e/U')^{1.5} \cdot 1/h$.

Switching Devices – Contactors and Contactor Assemblies – for Switching Motors

Power Contactors for Switching Motors



SIRIUS 3RT contactors, 3-pole up to 250 kW

Type	Contactors	
Size	3RT2015 to 3RT2018	
S00		
Conductor cross-sections		
Main conductors, auxiliary conductors and coil terminals (1 or 2 conductors can be connected)		
• Solid or stranded	mm ²	2 x (0.5 ... 1.5) ¹⁾ ; 2 x (0.75 ... 2.5) ¹⁾ ; max. 2 x 4
• Finely stranded with end sleeve (DIN 46228)	mm ²	2 x (0.5 ... 1.5) ¹⁾ ; 2 x (0.75 ... 2.5) ¹⁾
• AWG cables, solid or stranded	AWG	2 x (20 ... 16) ¹⁾ ; 2 x (18 ... 14) ¹⁾ ; 2 x 12
• Terminal screw		M3 (for Pozidriv size 2; Ø 5 ... 6)
• Tightening torque	Nm	0.8 ... 1.2 (7 ... 10.3 lb.in)
Main conductors, auxiliary conductors and coil terminals²⁾ (1 or 2 conductors can be connected)		
• Operating devices	mm	3.0 x 0.5
• Solid or stranded	mm ²	2 x (0.5 ... 4)
• Finely stranded with end sleeve (DIN 46228)	mm ²	2 x (0.5 ... 2.5)
• Finely stranded without end sleeve	mm ²	2 x (0.5 ... 2.5)
• AWG cables, solid or stranded	AWG	2 x (20 ... 12)
Auxiliary conductors for front and laterally mounted auxiliary switches²⁾ (1 or 2 conductors can be connected)		
• Operating devices	mm	3.0 x 0.5
• Solid or stranded	mm ²	2 x (0.5 ... 2.5)
• Finely stranded with end sleeve (DIN 46228)	mm ²	2 x (0.5 ... 1.5)
• Finely stranded without end sleeve	mm ²	2 x (0.5 ... 2.5)
• AWG cables, solid or stranded	AWG	2 x (20 ... 14)
¹⁾ If two different conductor cross-sections are connected to one clamping point, both cross-sections must lie in one of the ranges specified.		²⁾ Max. external diameter of the conductor insulation: 3.6 mm. On spring-loaded terminals with conductor cross-sections ≤ 1 mm ² an insulation stop is recommended, see page 3/120 .

Switching Devices – Contactors and Contactor Assemblies – for Switching Motors

Power Contactors for Switching Motors

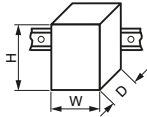
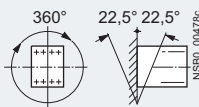
SIRIUS 3RT contactors, 3-pole up to 250 kW

		Contactors	
		3RT2023 to 3RT2025	3RT2026 to 3RT2028
Type		S0	
Size			
General data			
Dimensions (W x H x D)			
<u>AC operation</u>			
• Basic unit		mm	45 x 85 x 97
- Screw terminals		mm	45 x 102 x 97
- Spring-loaded terminals			
• Basic unit with mounted auxiliary switch		mm	45 x 85 x 141
- Screw terminals		mm	45 x 102 x 145
- Spring-loaded terminals			
• Basic unit with mounted function module or solid-state time-delay auxiliary switch		mm	45 x 85 x 171
- Screw terminals		mm	45 x 102 x 171
- Spring-loaded terminals			
<u>DC operation</u>			
• Basic unit		mm	45 x 85 x 107
- Screw terminals		mm	45 x 102 x 107
- Spring-loaded terminals			
• Basic unit with mounted auxiliary switch		mm	45 x 85 x 151
- Screw terminals		mm	45 x 102 x 155
- Spring-loaded terminals			
• Basic unit with mounted function module or solid-state time-delay auxiliary switch		mm	45 x 85 x 181
- Screw terminals		mm	45 x 102 x 181
- Spring-loaded terminals			
Permissible mounting position			
The contactors are designed for operation on a vertical mounting surface.			
Upright mounting position			
		Special version required, also applies for 3RT202.-K.40 coupling contactors	
Mechanical endurance			
• Basic unit and basic unit with mounted auxiliary switch	Operating cycles	10 million	
• Basic unit with solid-state compatible auxiliary switch	Operating cycles	5 million	
Electrical endurance			
For contact endurance of the main contacts, see page 3/24.			
Rated insulation voltage U_i (pollution degree 3)		V	690
Rated impulse withstand voltage U_{imp}			
• Auxiliary circuit	kV	6	
• Main circuit	kV	6	
Protective separation between the coil and the main contacts (acc. to IEC 60947-1, Appendix N)		V	400
Mirror contacts			
A mirror contact is an auxiliary NC contact that cannot be closed simultaneously with an NO main contact.			
• Integrated auxiliary switches		Yes, acc. to IEC 60947-4-1, Appendix F	
• 3RT2.2. (removable auxiliary switch)		Yes, acc. to IEC 60947-4-1, Appendix F	
Permissible ambient temperature			
• During operation	°C	-25 ... +60	
• During storage	°C	-55 ... +80	
Degree of protection acc. to IEC 60529			
• On front		IP20 (screw terminals and spring-loaded terminals)	
• Connecting terminal		IP20 (screw terminals and spring-loaded terminals)	
Touch protection acc. to IEC 60529			
Finger-safe (screw terminals and spring-loaded terminals)			
Shock resistance			
• Rectangular pulse			
- AC operation	g/ms	7.5/5 and 4.7/10	8.3/5 and 5.3/10
- DC operation	g/ms	10/5 and 7.5/10	
• Sine pulse			
- AC operation	g/ms	11.8/5 and 7.4/10	13.5/5 and 8.3/10
- DC operation	g/ms	15/5 and 10/10	

Switching Devices – Contactors and Contactor Assemblies – for Switching Motors

Power Contactors for Switching Motors

SIRIUS 3RT contactors, 3-pole up to 250 kW

Type	Contactors			
Size	3RT2023 to 3RT2025	3RT2026	3RT2027, 3RT2028	
S0				
Short-circuit protection				
Main circuit				
• Fuse links, operational class gG: LV HRC, type 3NA; DIAZED, type 5SB; NEOZED, type 5SE acc. to IEC/EN 60947-4-1	A	63	100	125
- Type of coordination "1"	A	25	35	50
- Type of coordination "2"	A	10	16	
- Weld-free (test conditions acc. to IEC 60947-4-1)	A	25	32	40
• Miniature circuit breaker with C characteristic (short-circuit current 3 kA, type of coordination "1")	A	25		
Auxiliary circuit				
• Fuse links, operational class gG: DIAZED, type 5SB; NEOZED, type 5SE (weld-free protection at $I_k \leq 1$ kA)	A	10		
• 230 V miniature circuit breaker, C characteristic (short-circuit current $I_k < 400$ A)	A	10		
Short-circuit protection for contactors with overload relays	See Configuration Manual for load feeders			
Short-circuit protection for fuseless load feeders	See 3RA2 load feeders, page 8/4 onwards			

Type	Contactors					
Size	3RT2023 to 3RT2025	3RT2026 to 3RT2028	3RT202.-.NB3	3RT202.-.NF3	3RT202.-.NP3	
S0						
Control						
Type of operating mechanism	AC or DC		AC/DC			
Solenoid coil operating range	AC/DC	0.8 ... 1.1 x U_s ¹⁾		0.7 ... 1.3 x U_s ²⁾		
Power consumption of the solenoid coils (for cold coil and 1.0 x U_s)						
• AC operation, 50 Hz, standard version						
- Closing	VA	65	77	6.6	11.9	12.7
- P.f.		0.82		0.98		
- Closed	VA	7.6	9.8	1.9	1.6	3.9
- P.f.		0.25		0.86	0.79	0.51
• AC operation, 50/60 Hz, standard version						
- Closing	VA	68/67	81/79	6.6/6.7	11.9/12.0	12.7/14.7
- P.f.		0.72/0.74		0.98/0.98		
- Closed	VA	7.9/6.5	10.5/8.5	1.9/2.0	1.6/1.8	3.9/4.3
- P.f.		0.25/0.28		0.86/0.82	0.79/0.74	0.51/0.56
• AC operation, 50 Hz, for USA/Canada						
- Closing	VA	65	77	--		
- P.f.		0.82	0.82	--		
- Closed	VA	7.6	9.8	--		
- P.f.		0.25	0.28	--		
• AC operation, 60 Hz, for USA/Canada						
- Closing	VA	73	87	--		
- P.f.		0.76		--		
- Closed	VA	7.2	9.4	--		
- P.f.		0.28		--		
• DC operation (closing = closed)	W	5.9/5.9		5.9/1.4	10.2/1.3	14.3/1.9
Permissible residual current of the electronics (with 0 signal)						
• AC operation	mA	< 6 mA x (230 V/ U_s)		< 7 mA x (230 V/ U_s)		
• DC operation	mA	< 16 mA x (24 V/ U_s)				
Operating times at 1.0 x U_s³⁾						
• AC operation						
- Closing delay	ms	10 ... 18	10 ... 17	65 ... 80	50 ... 70	60 ... 80
- Opening delay	ms	4 ... 16		30 ... 45	35 ... 45	30 ... 50
• DC operation						
- Closing delay	ms	55 ... 80		60 ... 80	56 ... 70	60 ... 80
- Opening delay	ms	16 ... 17		30 ... 45	35 ... 45	30 ... 50
• Arcing time	ms	10				

¹⁾ Coil operating range

- At 50 Hz: 0.8 to 1.1 x U_s
- At 60 Hz: 0.85 to 1.1 x U_s

²⁾ The following applies to $U_{s\max} = 280$ V: Upper limit = 1.1 x $U_{s\max}$

³⁾ The OFF-delay of the NO contact and the ON-delay of the NC contact are increased if the contactor coils are attenuated against voltage peaks (varistor +2 ms to 5 ms, diode assembly: 2x to 6x).

Switching Devices – Contactors and Contactor Assemblies – for Switching Motors

Power Contactors for Switching Motors

SIRIUS 3RT contactors, 3-pole up to 250 kW

		Coupling contactors	
Type		3RT202.-.KB4.	
Size		S0	
Control			
Solenoid coil operating range		0.7 ... 1.25 x U_s	
Power consumption of the solenoid coils (for cold coil) Closing = Closed	At U_s 24 V DC W	4.5	
Permissible residual current of the electronics (with 0 signal)		< 10 mA x ($24 V/U_s$)	
Overvoltage configuration of the solenoid coil		Integrated varistor  U	
Operating times			
• Closing delay			
- ON-delay NO	ms	65 ... 90	
- OFF-delay NC	ms	55 ... 80	
• Opening delay			
- ON-delay NO	ms	19 ... 21	
- OFF-delay NC	ms	25 ... 31	

		Contactors						
Type		3RT2023	3RT2024	3RT2025	3RT2026	3RT2027	3RT2028	
Size		S0						
Rated data of the main contacts								
Load rating with AC								
Utilization category AC-1, switching resistive loads								
• Rated operational current I_e		At 40 °C up to 690 V A	40				50	
		At 60 °C up to 690 V A	35				42	
• Rated power for AC loads ¹⁾ P.f. = 0.95 (at 60 °C)		230 V kW	13.3				15.5	
		400 V kW	23				27.5	
		690 V kW	40				47.5	
• Minimum cross-section in the main circuit for max. AC-1 rated value		mm ²	10					
Utilization categories AC-2 and AC-3								
• Rated operational currents I_e		Up to 400 V A	9	12	17	25	32	38
		440 V A	9	12	17	22	32	35
		500 V A	9	12	17	18	32	
		690 V A	9		13		21	
• Rated power for slipping or squirrel-cage motors at 50 and 60 Hz		At 230 V kW	2.2	3	4	5.5	7.5	11
		400 V kW	4	5.5	7.5	11	15	18.5
		690 V kW	7.5		11		18.5	
Thermal load capacity		10 s current A	80	110	150	200	260	304
Power loss per conducting path		At $I_e/AC-3$ W	0.4	0.5	0.9	1.6	2.7	3.8
Utilization category AC-4 (for $I_a = 6 \times I_e$)								
• Maximum values:								
- Rated operational current I_e		Up to 400 V A	8.5	12.5	15.5		22	
- Rated power for squirrel-cage motors with 50 Hz and 60 Hz		At 400 V kW	4	5.5	7.5		11	
• The following applies to a contact endurance of about 200 000 operating cycles:								
- Rated operational currents I_e		Up to 400 V A	4.1	5.5	7.7	9	12	
		690 V A	3.3	5.5	7.7	9	12	
- Rated power for squirrel-cage motors with 50 Hz and 60 Hz		At 110 V kW	0.5	0.73	1	1.2	1.6	
		230 V kW	1.1	1.5	2	2.5	3.4	
		400 V kW	2	2.6	3.5	4.4	6	
		690 V kW	2.5	4.6	6	7.7	10.3	

¹⁾ Industrial furnaces and electric heaters with resistance heating, etc.
(increased power consumption on heating up has been taken into account).

Switching Devices – Contactors and Contactor Assemblies – for Switching Motors

Power Contactors for Switching Motors

SIRIUS 3RT contactors, 3-pole up to 250 kW

Type	Contactors	
Size	3RT2023 to 3RT2025	3RT2026 to 3RT2028
	S0	

Rated data of the main contacts (continued)

Load rating with DC

Utilization category DC-1, switching resistive loads ($L/R \leq 1$ ms)

- Rated operational currents I_e (at 60 °C)

- 1 conducting path	Up to 24 V	A	35
	60 V	A	20
	110 V	A	4.5
	220 V	A	1
	440 V	A	0.4
	600 V	A	0.25
- 2 conducting paths in series	Up to 24 V	A	35
	60 V	A	35
	110 V	A	35
	220 V	A	5
	440 V	A	1
	600 V	A	0.8
- 3 conducting paths in series	Up to 24 V	A	35
	60 V	A	35
	110 V	A	35
	220 V	A	35
	440 V	A	2.9
	600 V	A	1.4

Utilization category DC-3/DC-5, shunt-wound and series-wound motors ($L/R \leq 15$ ms)

- Rated operational currents I_e (at 60 °C)

- 1 conducting path	Up to 24 V	A	20
	60 V	A	5
	110 V	A	2.5
	220 V	A	1
	440 V	A	0.09
	600 V	A	0.06
- 2 conducting paths in series	Up to 24 V	A	35
	60 V	A	35
	110 V	A	15
	220 V	A	3
	440 V	A	0.27
	600 V	A	0.16
- 3 conducting paths in series	Up to 24 V	A	35
	60 V	A	35
	110 V	A	35
	220 V	A	10
	440 V	A	0.6
	600 V	A	0.6

Switching frequency

Switching frequency z in operating cycles/hour

Contactors without overload relays

• No-load switching frequency	AC	1/h	5 000		
	DC	1/h	1 500		
• Switching frequency z during rated operation ¹⁾	- $I_e/AC-1$	At 400 V	1/h	1 000	
	- $I_e/AC-2$	At 400 V	1/h	1 000	750
	- $I_e/AC-3$	At 400 V	1/h	1 000	750
	- $I_e/AC-4$	At 400 V	1/h	300	250

Contactors with overload relays

- Mean value

1/h 15

¹⁾ Dependence of the switching frequency z' on the operational current I' and operational voltage U' :
 $z' = z \cdot (I_e/I') \cdot (U_e/U')^{1.5} \cdot 1/h$.

Switching Devices – Contactors and Contactor Assemblies – for Switching Motors

Power Contactors for Switching Motors

SIRIUS 3RT contactors, 3-pole up to 250 kW

Type Size	Contactors 3RT2023 to 3RT2028 S0	
Conductor cross-sections		
Main conductors (1 or 2 conductors can be connected)		
• Solid or stranded	mm ²	2 x (1 ... 2.5) ¹⁾ ; 2 x (2.5 ... 10) ¹⁾
• Finely stranded with end sleeve (DIN 46228)	mm ²	2 x (1 ... 2.5) ¹⁾ ; 2 x (2.5 ... 6) ¹⁾ ; 1 x 10
• AWG cables, solid or stranded	AWG	2 x (16 ... 12) ¹⁾ ; 2 x (14 ... 8) ¹⁾
• Terminal screws - Tightening torque	Nm	M4 (for Pozidriv size 2; Ø 5 ... 6) 2 ... 2.5 (18 ... 22 lb.in)
Auxiliary conductors (1 or 2 conductors can be connected)		
• Solid or stranded	mm ²	2 x (0.5 ... 1.5) ¹⁾ ; 2 x (0.75 ... 2.5) ¹⁾
• Finely stranded with end sleeve (DIN 46228)	mm ²	2 x (0.5 ... 1.5) ¹⁾ ; 2 x (0.75 ... 2.5) ¹⁾
• AWG cables, solid or stranded	AWG	2 x (20 ... 16) ¹⁾ ; 2 x (18 ... 14) ¹⁾
• Terminal screws - Tightening torque	Nm	M3 (for Pozidriv size 2; Ø 5 ... 6) 0.8 ... 1.2 (7 ... 10.3 lb.in)
Main conductors²⁾ (1 or 2 conductors can be connected)		
• Operating devices	mm	3.0 x 0.5
• Solid or stranded	mm ²	2 x (1 ... 10)
• Finely stranded with end sleeve (DIN 46228)	mm ²	2 x (1 ... 6)
• Finely stranded without end sleeve	mm ²	2 x (1 ... 6)
• AWG cables, solid or stranded	AWG	2 x (18 ... 8)
Auxiliary conductors²⁾ (1 or 2 conductors can be connected)		
• Operating devices		3.0 x 0.5
• Solid or stranded	mm ²	2 x (0.5 ... 2.5)
• Finely stranded with end sleeve (DIN 46228)	mm ²	2 x (0.5 ... 1.5)
• Finely stranded without end sleeve	mm ²	2 x (0.5 ... 2.5)
• AWG cables, solid or stranded	AWG	2 x (20 ... 14)

¹⁾ If two different conductor cross-sections are connected to one clamping point, both cross-sections must lie in one of the ranges specified.

²⁾ Max. external diameter of the conductor insulation: 6.4 mm.
On spring-loaded terminals with conductor cross-sections ≤ 1 mm² an insulation stop is recommended, see page 3/120.

Switching Devices – Contactors and Contactor Assemblies – for Switching Motors

Power Contactors for Switching Motors

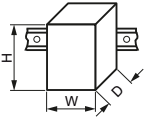
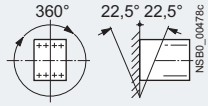
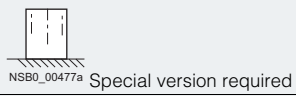

SIRIUS 3RT contactors, 3-pole up to 250 kW

Type Size	Contactors				
	3RT2035 S2	3RT2036	3RT2037	3RT2038	
General data					
Dimensions (W x H x D)					
<ul style="list-style-type: none"> Basic unit <ul style="list-style-type: none"> Screw/spring-loaded terminals Basic unit with mounted auxiliary switch <ul style="list-style-type: none"> Screw terminals Spring-loaded terminals Basic unit with mounted function module or solid-state time-delay auxiliary switch <ul style="list-style-type: none"> Screw/spring-loaded terminals 		mm	55 x 114 x 130		
		mm	55 x 114 x 174		
		mm	55 x 114 x 178		
		mm	55 x 114 x 204		
Permissible mounting position					
The contactors are designed for operation on a vertical mounting surface.					
Upright mounting position					
Mechanical endurance					
<ul style="list-style-type: none"> Basic unit and basic unit with mounted auxiliary switch 	Operating cycles	10 million			
<ul style="list-style-type: none"> Basic unit with solid-state compatible auxiliary switch 	Operating cycles	5 million			
Electrical endurance					
For contact endurance of the main contacts, see page 3/25 .					
Rated insulation voltage U_i (pollution degree 3)		V	690		
Rated impulse withstand voltage U_{imp}					
<ul style="list-style-type: none"> Auxiliary circuit 	kV	6			
<ul style="list-style-type: none"> Main circuit 	kV	6			
Protective separation between the coil and the main contacts (acc. to IEC 60947-1, Appendix N)		V	400		
Mirror contacts					
A mirror contact is an auxiliary NC contact that cannot be closed simultaneously with an NO main contact.					
<ul style="list-style-type: none"> Integrated auxiliary switches 3RT2.3. (removable auxiliary switch) 	Yes, acc. to IEC 60947-4-1, Appendix F Yes, acc. to IEC 60947-4-1, Appendix F				
Permissible ambient temperature					
<ul style="list-style-type: none"> During operation 	°C	-25 ... +60			
<ul style="list-style-type: none"> During storage 	°C	-55 ... +80			
Degree of protection acc. to IEC 60529					
<ul style="list-style-type: none"> On front Connecting terminal 	IP20 IP00 (for higher degree of protection, use additional terminal covers)				
Touch protection acc. to IEC 60529		Finger-safe for vertical touching from the front			
Shock resistance					
<ul style="list-style-type: none"> Rectangular pulse <ul style="list-style-type: none"> AC operation DC operation 	g/ms	11.8/5 and 7.4/10			
	g/ms	7.7/5 and 4.5/10			
<ul style="list-style-type: none"> Sine pulse <ul style="list-style-type: none"> AC operation DC operation 	g/ms	18.5/5 and 11.6/10			
	g/ms	12/5 and 7/10			
Short-circuit protection					
Main circuit					
<ul style="list-style-type: none"> Fuse links, operational class gG: LV HRC, type 3NA; DIAZED, type 5SB; NEOZED, type 5SE acc. to IEC/EN 60947-4-1 					
<ul style="list-style-type: none"> Type of coordination "1" 	A	160	250		
<ul style="list-style-type: none"> Type of coordination "2" 	A	80	125	160	
<ul style="list-style-type: none"> Weld-free (test conditions acc. to IEC 60947-4-1) 	A	16	25	50	
Auxiliary circuit					
<ul style="list-style-type: none"> Fuse links, operational class gG: DIAZED, type 5SB; NEOZED, type 5SE (weld-free protection at $I_k \leq 1$ kA) 	A	10			
<ul style="list-style-type: none"> 230 V miniature circuit breaker, C characteristic (short-circuit current $I_k < 400$ A) 	A	10			
Short-circuit protection for contactors with overload relays		See Configuration Manual for load feeders			
Short-circuit protection for fuseless load feeders		See 3RA2 load feeders, page 8/4 onwards			

Switching Devices – Contactors and Contactor Assemblies – for Switching Motors

Power Contactors for Switching Motors

SIRIUS 3RT contactors, 3-pole up to 250 kW

Type	Contactors		Coupling contactors
Size	3RT203.-A...	3RT203.-N.3.	3RT203.-KB4.
Control	S2		
Type of operating mechanism	AC	AC/DC	DC
Solenoid coil operating range			
• AC operation ¹⁾	0.8 ... 1.1 x U_s	--	--
• AC/DC operation ¹⁾	--	0.8 ... 1.1 x U_s	--
• DC operation	--	--	0.8 ... 1.2 x U_s
Power consumption of the solenoid coils (for cold coil and 1.0 x U_s)			
• AC operation, 50 Hz, standard version			
- Closing	VA	190	--
- P.f.		0.72	--
- Closed	VA	16	--
- P.f.		0.37	--
• AC operation, 50/60 Hz, standard version			
- Closing	VA	210/188	--
- P.f.		0.69/0.65	--
- Closed	VA	17.2/16.5	--
- P.f.		0.36/0.39	--
• AC operation, 60 Hz, for USA/Canada			
- Closing	VA	212	--
- P.f.		0.67	--
- Closed	VA	18.5	--
- P.f.		0.37	--
• AC/DC operation			
- Closing for AC operation	VA	--	40
- P.f.		--	0.95
- Closed for AC operation	VA	--	2
- P.f.		--	0.95
• DC operation			
- Closing for DC operation	W	--	23 ²⁾
- Closed for DC operation	W	--	1
Permissible residual current of the electronics (with 0 signal)			
• AC/DC operation	mA	--	< 20
• DC operation	mA	--	< 20
Overvoltage configuration of the solenoid coil	--	Integrated varistor 	Integrated varistor 
Operating times at 0.7 ... 1.25 x U_s⁴⁾ Total break time = Opening delay + Arcing time			
• DC operation			
- Closing delay	ms	--	45 ... 60
- Opening delay	ms	--	35 ... 55
Operating times at 1.0 x U_s⁴⁾			
• AC operation			
- Closing delay	ms	12 ... 22	35 ... 80
- Opening delay	ms	10 ... 18	30 ... 55
• DC operation			
- Closing delay	ms	--	35 ... 80
- Opening delay	ms	--	30 ... 55
• Arcing time	ms	10 ... 20	

¹⁾ Coil operating range
- At 50 Hz: 0.8 to 1.1 x U_s
- At 60 Hz: 0.85 to 1.1 x U_s

²⁾ In the case of AC/DC coils, increased pickup currents (2.6 A on average) arise during the first 200 ms. For direct control by PLC, we therefore recommend special coupling contactors with reduced power consumption. The connection of one 3RT203.-KB4. coupling contactor is possible per PLC output port with an output current of 2 A, see page 3/66.

³⁾ In the case of DC coils, increased pickup currents (2.2 A on average) arise during the first 200 ms.

⁴⁾ The OFF-delay of the NO contact and the ON-delay of the NC contact are increased if the contactor coils are attenuated against voltage peaks (varistor +2 ms to 5 ms, diode assembly: 2x to 6x).

Switching Devices – Contactors and Contactor Assemblies – for Switching Motors

Power Contactors for Switching Motors

SIRIUS 3RT contactors, 3-pole up to 250 kW

Type Size	Contactors					
	3RT2035 S2	3RT2036	3RT2037	3RT2038		
Rated data of the main contacts						
Load rating with AC						
Utilization category AC-1, switching resistive loads						
• Rated operational current I_e	At 40 °C up to 690 V At 60 °C up to 690 V	A A	60 55	70 60	80 70	90 80
• Rated power for AC loads ¹⁾ P.f. = 0.95 (at 60 °C)	230 V 400 V 690 V	kW kW kW	23 39 68	26 46 79	30 53 91	34 59 102
• Minimum cross-section in the main circuit for max. AC-1 rated value		mm ²	16	25		35
Utilization categories AC-2 and AC-3						
• Rated operational currents I_e	Up to 400 V 440 V 500 V 690 V	A A A A	40 40 40 24	50 50 50	65 65 65 47	80 80 80 58
• Rated power for slipring or squirrel-cage motors at 50 and 60 Hz	At 230 V 400 V 690 V	kW kW kW	11 18.5 22	15 22	18.5 30 37	22 37 45
Thermal load capacity	10 s current	A	400	420	520	640
Power loss per conducting path	At $I_e/AC-3$	W	2.2	4	3.8	5.7
Utilization category AC-4 (for $I_a = 6 \times I_e$)						
• Maximum values						
- Rated operational current I_e	Up to 400 V	A	35	41	55	
- Rated power for squirrel-cage motors with 50 Hz and 60 Hz	At 400 V	kW	18.5	22	30	
• The following applies to a contact endurance of about 200 000 operating cycles:						
- Rated operational currents I_e	Up to 400 V 690 V	A A	22 18.5	24 20	28 22	30 24
- Rated power for squirrel-cage motors with 50 Hz and 60 Hz	At 110 V 230 V 400 V 690 V	kW kW kW kW	3.2 6.7 11.6 16.8	3.5 7.3 12.6 18.2	4.1 8.5 14.7 20	4.3 9.1 15.8 21.8

¹⁾ Industrial furnaces and electric heaters with resistance heating, etc. (increased power consumption on heating up has been taken into account).

Switching Devices – Contactors and Contactor Assemblies – for Switching Motors

Power Contactors for Switching Motors

SIRIUS 3RT contactors, 3-pole up to 250 kW

Type Size	Contactors			
	3RT2035	3RT2036	3RT2037	3RT2038
Rated data of the main contacts (continued)				
Load rating with DC				
Utilization category DC-1, switching resistive loads ($L/R \leq 1$ ms)				
• Rated operational currents I_e (at 60 °C)				
- 1 conducting path	Up to 24 V A	55		
	60 V A	23		
	110 V A	4.5		
	220 V A	1		
	440 V A	0.4		
	600 V A	0.25		
- 2 conducting paths in series	Up to 24 V A	55		
	60 V A	45		
	110 V A	45		
	220 V A	5		
	440 V A	1		
	600 V A	0.8		
- 3 conducting paths in series	Up to 24 V A	55		
	60 V A	55		
	110 V A	55		
	220 V A	45		
	440 V A	2.9		
	600 V A	1.4		
Utilization category DC-3/DC-5, shunt-wound and series-wound motors ($L/R \leq 15$ ms)				
• Rated operational currents I_e (at 60 °C)				
- 1 conducting path	Up to 24 V A	35		
	60 V A	6		
	110 V A	2.5		
	220 V A	1		
	440 V A	0.1		
	600 V A	0.06		
- 2 conducting paths in series	Up to 24 V A	55		
	60 V A	45		
	110 V A	25		
	220 V A	5		
	440 V A	0.27		
	600 V A	0.16		
- 3 conducting paths in series	Up to 24 V A	55		
	60 V A	55		
	110 V A	55		
	220 V A	25		
	440 V A	0.6		
	600 V A	0.35		
Switching frequency				
Switching frequency z in operating cycles/hour				
Contactors without overload relays				
• No-load switching frequency	AC 1/h	5 000		
	AC/DC 1/h	1 500		
• Switching frequency z during rated operation ¹⁾				
- $I_e/AC-1$	At 400 V 1/h	1 200	1 000	800
- $I_e/AC-2$	At 400 V 1/h	750	600	400
- $I_e/AC-3$	At 400 V 1/h	1 000	800	700
- $I_e/AC-4$	At 400 V 1/h	300	250	200
Contactors with overload relays				
• Mean value	1/h	15		

¹⁾ Dependence of the switching frequency z' on the operational current I' and operational voltage U:
 $z' = z \cdot (I_e/I') \cdot (U_e/U)^{1.5} \cdot 1/h.$

Switching Devices – Contactors and Contactor Assemblies – for Switching Motors

Power Contactors for Switching Motors

SIRIUS 3RT contactors, 3-pole up to 250 kW

Type Size	Contactors 3RT2035 to 3RT2038 S2	
Conductor cross-sections		
Main conductors (1 or 2 conductors can be connected)		
• Solid or stranded	mm ²	2 x (1 ... 35) ¹⁾ ; 1 x (1 ... 50) ¹⁾
• Finely stranded with end sleeve (DIN 46228)	mm ²	2 x (1 ... 25) ¹⁾ ; 1 x (1 ... 35) ¹⁾
• AWG cables, solid or stranded	AWG	2 x (18 ... 2) ¹⁾ ; 1 x (18 ... 1) ¹⁾
• Terminal screws - Tightening torque	Nm	Pozidriv size 2; Ø 5 ... 6 3 ... 4.5 (27 ... 40 lb.in)
Auxiliary conductors and control conductors (1 or 2 conductors can be connected)		
• Solid or stranded	mm ²	2 x (0.5 ... 1.5) ¹⁾ ; 2 x (0.75 ... 2.5) ¹⁾
• Finely stranded with end sleeve (DIN 46228)	mm ²	2 x (0.5 ... 1.5) ¹⁾ ; 2 x (0.75 ... 2.5) ¹⁾
• AWG cables, solid or stranded	AWG	2 x (20 ... 16) ¹⁾ ; 2 x (18 ... 14) ¹⁾
• Terminal screws - Tightening torque	Nm	M3 (for Pozidriv size 2; Ø 5 ... 6) 0.8 ... 1.2 (7 ... 10.3 lb.in)
Auxiliary and control conductors²⁾ (1 or 2 conductors can be connected)		
• Operating devices	mm	3.0 x 0.5
• Solid or stranded	mm ²	2 x (0.5 ... 2.5)
• Finely stranded with end sleeve (DIN 46228)	mm ²	2 x (0.5 ... 1.5)
• Finely stranded without end sleeve	mm ²	2 x (0.5 ... 2.5)
• AWG cables, solid or stranded	AWG	2 x (20 ... 14)
¹⁾ If two different conductor cross-sections are connected to one clamping point, both cross-sections must lie in one of the ranges specified.		²⁾ Max. external diameter of the conductor insulation: 3.6 mm. On spring-loaded terminals with conductor cross-sections ≤ 1 mm ² an insulation stop is recommended, see page 3/120 .

Switching Devices – Contactors and Contactor Assemblies – for Switching Motors

Power Contactors for Switching Motors

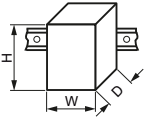
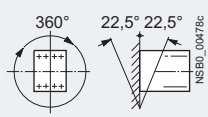
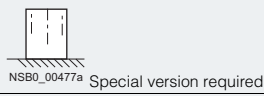

SIRIUS 3RT contactors, 3-pole up to 250 kW

		Contactors		
		3RT2045	3RT2046	3RT2047
Type				
Size		S3		
General data				
Dimensions (W x H x D)				
<ul style="list-style-type: none"> Basic unit <ul style="list-style-type: none"> Screw/spring-loaded terminals Basic unit with mounted auxiliary switch <ul style="list-style-type: none"> Screw terminals Spring-loaded terminals Basic unit with mounted function module or solid-state time-delay auxiliary switch <ul style="list-style-type: none"> Screw/spring-loaded terminals 		mm	70 x 140 x 152	
		mm	70 x 140 x 196	
		mm	70 x 140 x 200	
		mm	70 x 140 x 226	
Permissible mounting position				
The contactors are designed for operation on a vertical mounting surface.				
Upright mounting position				
Mechanical endurance				
<ul style="list-style-type: none"> Basic unit and basic unit with mounted auxiliary switch 	Operating cycles	10 million		
<ul style="list-style-type: none"> Basic unit with solid-state compatible auxiliary switch 	Operating cycles	5 million		
Electrical endurance				
For contact endurance of the main contacts, see page 3/25 .				
Rated insulation voltage U_i (pollution degree 3)		V	1 000 (3RT20...-.....-OCC0: 690)	
Rated impulse withstand voltage U_{imp}				
<ul style="list-style-type: none"> Auxiliary circuit 	kV	6		
<ul style="list-style-type: none"> Main circuit 	kV	8		
Protective separation between the coil and the main contacts (acc. to IEC 60947-1, Appendix N)		V	690	
Mirror contacts				
A mirror contact is an auxiliary NC contact that cannot be closed simultaneously with an NO main contact.				
<ul style="list-style-type: none"> Integrated auxiliary switches 3RT2.4. (removable auxiliary switch) 	Yes, acc. to IEC 60947-4-1, Appendix F Yes, acc. to IEC 60947-4-1, Appendix F			
Permissible ambient temperature				
<ul style="list-style-type: none"> During operation 	°C	-25 ... +60		
<ul style="list-style-type: none"> During storage 	°C	-55 ... +80		
Degree of protection acc. to IEC 60529				
<ul style="list-style-type: none"> On front 	IP20			
<ul style="list-style-type: none"> Connecting terminal 	IP00 (for higher degree of protection, use additional terminal covers)			
Touch protection acc. to IEC 60529		Finger-safe for vertical touching from the front		
Shock resistance				
<ul style="list-style-type: none"> Rectangular pulse <ul style="list-style-type: none"> AC operation DC operation 	g/ms	10.3/5 and 6.7/10		
	g/ms	6.7/5 and 4.0/10 (3RT204.-.KB40: 6.3/5 and 3.6/10)		
<ul style="list-style-type: none"> Sine pulse <ul style="list-style-type: none"> AC operation DC operation 	g/ms	16.3/5 and 10.5/10		
	g/ms	10.6/5 and 6.3/10 (3RT204.-.KB40: 9.8/5 and 5.6/10)		
Short-circuit protection				
Main circuit				
<ul style="list-style-type: none"> Fuse links, operational class gG: LV HRC, type 3NA; DIAZED, type 5SB; NEOZED, type 5SE acc. to IEC/EN 60947-4-1 				
<ul style="list-style-type: none"> - Type of coordination "1" - Type of coordination "2" - Weld-free (test conditions acc. to IEC 60947-4-1) 	A	250		
	A	160	160	200
	A	On request		
Auxiliary circuit				
<ul style="list-style-type: none"> Fuse links, operational class gG: DIAZED, type 5SB; NEOZED, type 5SE (weld-free protection at $I_k \leq 1$ kA) 	A	10		
<ul style="list-style-type: none"> 230 V miniature circuit breaker, C characteristic (short-circuit current $I_k < 400$ A) 	A	10		
Short-circuit protection for contactors with overload relays		See Configuration Manual for load feeders		
Short-circuit protection for fuseless load feeders		See 3RA2 load feeders, page 8/4 onwards		

Switching Devices – Contactors and Contactor Assemblies – for Switching Motors

Power Contactors for Switching Motors

SIRIUS 3RT contactors, 3-pole up to 250 kW

Type Size		3RT204.-A... S3	3RT204.-N.3.	Coupling contactors 3RT204.-KB4.
Control				
Type of operating mechanism		AC	AC/DC	DC
Solenoid coil operating range				
• AC operation ¹⁾		0.8 ... 1.1 x U_s	--	--
• AC/DC operation ¹⁾		--	0.8 ... 1.1 x U_s	--
• DC operation		--	--	0.8 ... 1.2 x U_s
Power consumption of the solenoid coils (for cold coil and 1.0 x U_s)				
• AC operation, 50 Hz, standard version				
- Closing	VA	296	--	--
- P.f.		0.61	--	--
- Closed	VA	19	--	--
- P.f.		0.38	--	--
• AC operation, 50/60 Hz, standard version				
- Closing	VA	348/296	--	--
- P.f.		0.62/0.55	--	--
- Closed	VA	25/18	--	--
- P.f.		0.35/0.41	--	--
• AC operation, 60 Hz, for USA/Canada				
- Closing	VA	326	--	--
- P.f.		0.62	--	--
- Closed	VA	22	--	--
- P.f.		0.38	--	--
• AC/DC operation				
- Closing for AC operation	VA	--	163	--
- P.f.		--	0.95	--
- Closed for AC operation	VA	--	3.1	--
- P.f.		--	0.95	--
• DC operation				
- Closing for DC operation	W	--	76 ²⁾	25 ³⁾
- Closed for DC operation	W	--	1.8	0.9
Permissible residual current of the electronics (with 0 signal)				
• AC/DC operation	mA	--	< 20	--
• DC operation	mA	--	--	< 20
Overtoltage configuration of the solenoid coil		--	Integrated varistor 	Integrated varistor 
Operating times at 0.8 ... 1.2 x U_s⁴⁾				
Total break time = Opening delay + Arcing time				
• DC operation				
- Closing delay	ms	--	--	50 ... 70
- Opening delay	ms	--	--	38 ... 57
Operating times at 1.0 x U_s⁴⁾				
• AC operation				
- Closing delay	ms	15 ... 25	50 ... 70	--
- Opening delay	ms	11 ... 20	38 ... 57	--
• DC operation				
- Closing delay	ms	--	50 ... 70	--
- Opening delay	ms	--	38 ... 57	--
• Arcing time	ms	10 ... 20	--	--

1) Coil operating range

- At 50 Hz: 0.8 to 1.1 x U_s
- At 60 Hz: 0.85 to 1.1 x U_s

2) In the case of AC/DC coils, increased pickup currents (6.5 A on average) arise during the first 200 ms. For direct control by PLC, we therefore recommend special coupling contactors with reduced power consumption. The connection of one 3RT204.-KB4. coupling contactor is possible per PLC output port with an output current of 2 A, see page 3/66.

3) In the case of DC coils, increased pickup currents (6.5 A on average) arise during the first 200 ms.

4) The OFF-delay of the NO contact and the ON-delay of the NC contact are increased if the contactor coils are attenuated against voltage peaks (varistor +2 ms to 5 ms, diode assembly: 2x to 6x).

Switching Devices – Contactors and Contactor Assemblies – for Switching Motors

Power Contactors for Switching Motors

SIRIUS 3RT contactors, 3-pole up to 250 kW

Type Size	Contactors		
	3RT2045 S3	3RT2046	3RT2047
Rated data of the main contacts			
Load rating with AC			
Utilization category AC-1, switching resistive loads			
• Rated operational current I_e	At 40 °C up to 690 V A At 60 °C up to 690 V A	125 105	130 110
• Rated power for AC loads ¹⁾ P.f. = 0.95 (at 60 °C)	230 V kW 400 V kW 690 V kW	40 69 119	42 72 125
• Minimum cross-section in the main circuit for max. AC-1 rated value	mm ²	50	
Utilization categories AC-2 and AC-3			
• Rated operational currents I_e	Up to 400 V A 500 V A 690 V A 1 000 V A	80 80 58 30	95 95 78 110 98
• Rated power for slipring or squirrel-cage motors at 50 and 60 Hz	At 230 V kW 400 V kW 690 V kW 1 000 V kW	22 37 55 37	22 45 75 30 55 90
Thermal load capacity	10 s current A	760	880
Power loss per conducting path	At I_e /AC-3 W	5.3	6.6 7.9
Utilization category AC-4 (for $I_a = 6 \times I_e$)			
• Maximum values			
- Rated operational current I_e	Up to 400 V A	66	80 97
- Rated power for squirrel-cage motors with 50 Hz and 60 Hz	At 400 V kW	37	45 55
• The following applies to a contact endurance of about 200 000 operating cycles:			
- Rated operational currents I_e	Up to 400 V A 690 V A	34 24	42 30 46 36
- Rated power for squirrel-cage motors with 50 Hz and 60 Hz	At 110 V kW 230 V kW 400 V kW 690 V kW	4.9 10.4 17.9 21.8	6.1 12 22 27.4 6.7 14 24.3 32.9

¹⁾ Industrial furnaces and electric heaters with resistance heating, etc.
(increased power consumption on heating up has been taken into account).

Switching Devices – Contactors and Contactor Assemblies – for Switching Motors

Power Contactors for Switching Motors

SIRIUS 3RT contactors, 3-pole up to 250 kW



Type Size	Contactors		
	3RT2045 S3	3RT2046	3RT2047
Rated data of the main contacts (continued)			
Load rating with DC			
Utilization category DC-1, switching resistive loads ($L/R \leq 1$ ms)			
• Rated operational currents I_e (at 60 °C)			
- 1 conducting path	Up to 24 V A	100	
	60 V A	60	
	110 V A	9	
	220 V A	2	
	440 V A	0.6	
	600 V A	0.4	
- 2 conducting paths in series	Up to 24 V A	100	
	60 V A	100	
	110 V A	100	
	220 V A	10	
	440 V A	1.8	
	600 V A	1.0	
- 3 conducting paths in series	Up to 24 V A	100	
	60 V A	100	
	110 V A	100	
	220 V A	80	
	440 V A	4.5	
	600 V A	2.6	
Utilization category DC-3/DC-5, shunt-wound and series-wound motors ($L/R \leq 15$ ms)			
• Rated operational currents I_e (at 60 °C)			
- 1 conducting path	Up to 24 V A	40	
	60 V A	6	
	110 V A	2.5	
	220 V A	1	
	440 V A	0.15	
	600 V A	0.06	
- 2 conducting paths in series	Up to 24 V A	100	
	60 V A	100	
	110 V A	100	
	220 V A	7	
	440 V A	0.42	
	600 V A	0.16	
- 3 conducting paths in series	Up to 24 V A	100	
	60 V A	100	
	110 V A	100	
	220 V A	35	
	440 V A	0.8	
	600 V A	0.35	
Switching frequency			
Switching frequency z in operating cycles/hour			
Contactors without overload relays			
• No-load switching frequency	AC 1/h	5 000	
	AC/DC 1/h	1 000	
• Switching frequency z during rated operation ¹⁾			
- $I_e/AC-1$	At 400 V 1/h	900	
- $I_e/AC-2$	At 400 V 1/h	400	350
- $I_e/AC-3$	At 400 V 1/h	1 000	850
- $I_e/AC-4$	At 400 V 1/h	300	250
Contactors with overload relays			
• Mean value	1/h	15	200

¹⁾ Dependence of the switching frequency z' on the operational current I' and operational voltage U:
 $z' = z \cdot (I_e/I') \cdot (U_e/U)^{1.5} \cdot 1/h.$

Switching Devices – Contactors and Contactor Assemblies – for Switching Motors

Power Contactors for Switching Motors

SIRIUS 3RT contactors, 3-pole up to 250 kW

Type Size	Contactors 3RT2045 to 3RT2047 S3	
Conductor cross-sections		
Main conductors (1 or 2 conductors can be connected)		
<ul style="list-style-type: none"> • Solid • Stranded • Finely stranded with end sleeve (DIN 46228) • AWG cables, solid or stranded • Terminal screws - Tightening torque 	mm ² mm ² mm ² AWG Nm	 Screw terminals 2 x (2.5 ... 16) ¹⁾ 2 x (6 ... 16) ¹⁾ ; 2 x (10 ... 50) ¹⁾ ; 1 x (10 ... 70) ¹⁾ 2 x (2.5 ... 35) ¹⁾ ; 1 x (2.5 ... 50) ¹⁾ 2 x (10 ... 1/0) ¹⁾ ; 1 x (10 ... 2/0) ¹⁾ Hexagon socket, A/F 4 4.5 ... 6 (40 ... 53 lb.in)
Auxiliary conductors and control conductors (1 or 2 conductors can be connected)		
<ul style="list-style-type: none"> • Solid or stranded • Finely stranded with end sleeve (DIN 46228) • AWG cables, solid or stranded • Terminal screws - Tightening torque 	mm ² mm ² AWG Nm	2 x (0.5 ... 1.5) ¹⁾ ; 2 x (0.75 ... 2.5) ¹⁾ 2 x (0.5 ... 1.5) ¹⁾ ; 2 x (0.75 ... 2.5) ¹⁾ 2 x (20 ... 16) ¹⁾ ; 2 x (18 ... 14) ¹⁾ M3 (for Pozidriv size 2; Ø 5 ... 6) 0.8 ... 1.2 (7 ... 10.3 lb.in)
Auxiliary and control conductors²⁾ (1 or 2 conductors can be connected)		
<ul style="list-style-type: none"> • Operating devices • Solid or stranded • Finely stranded with end sleeve (DIN 46228) • Finely stranded without end sleeve • AWG cables, solid or stranded 	mm mm ² mm ² mm ² AWG	 Spring-loaded terminals 3.0 x 0.5 2 x (0.5 ... 2.5) 2 x (0.5 ... 1.5) 2 x (0.5 ... 2.5) 2 x (20 ... 16)
¹⁾ If two different conductor cross-sections are connected to one clamping point, both cross-sections must lie in one of the ranges specified.		²⁾ Max. external diameter of the conductor insulation: 3.6 mm. On spring-loaded terminals with conductor cross-sections ≤ 1 mm ² an insulation stop is recommended, see page 3/120.

Switching Devices – Contactors and Contactor Assemblies – for Switching Motors

Power Contactors for Switching Motors

SIRIUS 3RT contactors, 3-pole up to 250 kW

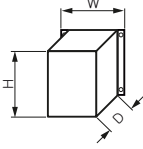
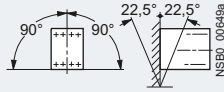
Type	Contactors						
	3RT1054	3RT1055, 3RT1056	3RT1064 to 3RT1066	3RT1075	3RT1076		
Size	S6		S10	S12			
General data							
Dimensions (W x H x D)							
<ul style="list-style-type: none"> Basic unit Basic unit with mounted auxiliary switch 			mm	120 x 172 x 170	145 x 210 x 202	160 x 214 x 225	
			mm	120 x 172 x 217	145 x 210 x 251	160 x 214 x 271	
Permissible mounting position							
The contactors are designed for operation on a vertical mounting surface.							
Mechanical endurance			Operating cycles	10 million			
Electrical endurance				For contact endurance of the main contacts, see page 3/25 .			
Rated insulation voltage U_i (pollution degree 3)			V	1 000			
Rated impulse withstand voltage U_{imp}							
• Auxiliary circuit			kV	6			
• Main circuit			kV	8			
Protective separation between the coil and the main contacts acc. to IEC 60947-1, Appendix N			V	690			
Mirror contacts				Yes, acc. to IEC 60947-4-1, Appendix F			
A mirror contact is an auxiliary NC contact that cannot be closed simultaneously with an NO main contact.							
Permissible ambient temperature							
• During operation			°C	-25 ... +60			
• During storage			°C	-55 ... +80			
Degree of protection acc. to IEC 60529							
• On front				IP00 (IP20 with box terminal/cover)			
• Connecting terminal				IP00 (for higher degree of protection, use additional terminal covers) Finger-safe for vertical touching from the front with cover			
Touch protection acc. to IEC 60529							
Shock resistance							
• Rectangular pulse			g/ms	8.5/5 and 4.2/10			
• Sine pulse			g/ms	13.4/5 and 6.5/10			
Electromagnetic compatibility (EMC)				See page 3/19			
Short-circuit protection							
Main circuit							
Fuse links, operational class gG: LV HRC, type 3NA; DIAZED, type 5SB; NEOZED, type 5SE acc. to IEC/EN 60947-4-1							
• Type of coordination "1"			A	355	500	630	
• Type of coordination "2"			A	250	315	400	500
• Weld-free			A	80	160	250	315
Auxiliary circuit							
Short-circuit test							
• With fuse links of operational class gG: DIAZED, type 5SB; NEOZED, type 5SE with short-circuit current $I_k = 1$ kA acc. to IEC 60947-5-1			A	10			
• With miniature circuit breakers with C characteristic with short-circuit current $I_k = 400$ A			A	10			
Short-circuit protection for contactors with overload relays				See Configuration Manual for load feeders			

Switching Devices – Contactors and Contactor Assemblies – for Switching Motors

Power Contactors for Switching Motors

SIRIUS 3RT contactors, 3-pole up to 250 kW

Type Size	Contactors				
	3RT105. S6	3RT106. S10	3RT107. S12		
Control					
Operating range of the solenoid operating mechanism	AC/DC	0.8 x $U_{s \text{ min}}$... 1.1 x $U_{s \text{ max}}$			
Power consumption of the solenoid operating mechanism (with cold coil and rated range $U_{s \text{ min}}$... $U_{s \text{ max}}$)					
• Standard operating mechanism (3RT10...-A)					
- AC operation	Closing at $U_{s \text{ min}}$ Closing at $U_{s \text{ max}}$ Closed at $U_{s \text{ min}}$ Closed at $U_{s \text{ max}}$	VA/p.f. VA/p.f. VA/p.f. VA/p.f.	250/0.9 300/0.9 4.8/0.8 5.8/0.8	490/0.9 590/0.9 5.6/0.9 6.7/0.9	700/0.9 830/0.9 7.6/0.9 9.2/0.9
- DC operation	Closing at $U_{s \text{ min}}$ Closing at $U_{s \text{ max}}$ Closed at $U_{s \text{ min}}$ Closed at $U_{s \text{ max}}$	W W W W	300 360 4.3 5.2	540 650 6.1 7.4	770 920 8.5 10
• Solid-state operating mechanism (3RT10...-N/-P/-S)					
- AC operation	Closing at $U_{s \text{ min}}$ Closing at $U_{s \text{ max}}$ Closed at $U_{s \text{ min}}$ Closed at $U_{s \text{ max}}$	VA/p.f. VA/p.f. VA/p.f. VA/p.f.	190/0.8 280/0.8 3.5/0.6 4.8/0.6	400/0.8 530/0.8 5.5/0.5 8.5/0.4	560/0.8 750/0.8 5.6/0.5 9/0.4
- DC operation	Closing at $U_{s \text{ min}}$ Closing at $U_{s \text{ max}}$ Closed at $U_{s \text{ min}}$ Closed at $U_{s \text{ max}}$	W W W W	250 320 2.1 2.8	440 580 2.8 3.4	600 800 3 3.6
PLC control input acc. to IEC 60947-1					
• Solid-state operating mechanism 3RT10...-N/-P 3RT10...-S					
• Rated voltage		V DC	24	Type 2 Type 1	
• Operating range		V DC	17 ... 30		
• Power consumption		mA	≤ 30		
• Recovery time after mains failure, typical (applicable only for fail-safe version 3RT10...-S)		s	2		
Operating times for rated range $U_{s \text{ min}}$... $U_{s \text{ max}}$ (Total break time = Opening delay + Arcing time)					
• Standard operating mechanism (3RT10...-A)					
	Closing delay	ms	25 ... 50	35 ... 50	50 ... 70
	Opening delay	ms	40 ... 60	50 ... 80	70 ... 100
• Solid-state operating mechanism					
- Actuated via A1/A2 (3RT10...-N/-P)	Closing delay	ms	100 ... 120	110 ... 130	125 ... 150
	Opening delay	ms	80 ... 100		
- Actuated via PLC input (3RT10...-N/-P)	Closing delay	ms	40 ... 60	50 ... 65	65 ... 80
	Opening delay	ms	80 ... 100		
- Actuated via F-PLC input (3RT10...-S)	Closing delay	ms	60 ... 75		
	Opening delay	ms	115 ... 130		
• Arcing time		ms	10 ... 15		

Switching Devices – Contactors and Contactor Assemblies – for Switching Motors

Power Contactors for Switching Motors

SIRIUS 3RT contactors, 3-pole up to 250 kW

Type Size	Contactors							
	3RT1054 S6	3RT1055	3RT1056	3RT1064 S10	3RT1065	3RT1066	3RT1075 S12	3RT1076
Rated data of the main contacts								
Load rating with AC								
Utilization category AC-1, switching resistive loads								
• Rated operational currents I_e								
- At 40 °C up to 690 V	A	160	185	215	275	330	430	610
- At 60 °C up to 690 V	A	140	160	185	250	300	400	550
- At 60 °C up to 1 000 V	A	80	90	100		150	200	
• Rated power for AC loads ¹⁾ with p.f. = 0.95 (at 60 °C)								
- At 230 V	kW	53	60	70	94	113	151	208
- At 400 V	kW	92	105	121	164	197	263	362
- At 500 V	kW	115	131	152	205	246	329	452
- At 690 V	kW	159	181	210	283	340	454	624
- At 1 000 V	kW	131	148	165	164	246	329	
• Minimum cross-section in the main circuit for max. AC-1 rated value	mm ²	70	95		150	185	300	370
Utilization categories AC-2 and AC-3								
• Rated operational currents I_e								
- Up to 500 V	A	115	150	185	225	265	300	400
- At 690 V	A	115	150	170	225	265	280	400
- At 1 000 V	A	53	65		68	95	180	180
• Rated power for slipring or squirrel-cage motors at 50 and 60 Hz								
- At 230 V	kW	37	50	61	73	85	97	132
- At 400 V	kW	64	84	104	128	151	171	231
- At 500 V	kW	81	105	132	160	189	215	291
- At 690 V	kW	113	146	167	223	265	280	400
- At 1 000 V	kW	75	90			132	250	453
Thermal load capacity, 10 s current	A	1 100	1 300	1 480	1 800	2 400	3 200	4 000
Power loss per main conducting path At $I_e/AC-3/500$ V	W	7	9	13	17	18	22	35
Utilization category AC-4 (for $I_a = 6 \times I_e$)								
Maximum values:								
• Rated operational current I_e								
- Up to 400 V	A	97	132	160	195	230	280	350
• Rated power for squirrel-cage motors with 50 Hz and 60 Hz								
- At 400 V	kW	55	75	90	110	132	160	200
The following applies to a contact endurance of about 200 000 operating cycles:								
• Rated operational currents I_e								
- Up to 500 V	A	54	68	81	96	117	125	150
- Up to 690 V	A	48	57	65	85	105	115	135
• Rated power for squirrel-cage motors with 50 Hz and 60 Hz								
- At 230 V	kW	16	20	25	30	37	40	48
- At 400 V	kW	29	38	45	54	66	71	85
- At 500 V	kW	37	47	57	67	82	87	105
- At 690 V	kW	48	55	65	82	102	112	133

¹⁾ Industrial furnaces and electric heaters with resistance heating, etc. (increased power consumption on heating up has been taken into account).

Switching Devices – Contactors and Contactor Assemblies – for Switching Motors

Power Contactors for Switching Motors

SIRIUS 3RT contactors, 3-pole up to 250 kW





Type Size	Contactors						
	3RT1054 S6	3RT1055, 3RT1056	3RT1064 S10	3RT1065	3RT1066	3RT1075 S12	3RT1076
Rated data of the main contacts (continued)							
Load rating with DC							
Utilization category DC-1, switching resistive loads ($L/R \leq 1$ ms)							
• Rated operational currents I_e (at 60 °C)							
- 1 conducting path	Up to 24 V A	160	200	300		400	
	60 V A	160	200	300		330	
	110 V A	18		33			
	220 V A	3.4		3.8			
	440 V A	0.8		0.9			
	600 V A	0.5		0.6			
- 2 conducting paths in series	Up to 24 V A	160	200	300		400	
	60 V A	160	200	300		400	
	110 V A	160	200	300		400	
	220 V A	20		300		400	
	440 V A	3.2		4			
	600 V A	1.6		2			
- 3 conducting paths in series	Up to 24 V A	160	200	300		400	
	60 V A	160	200	300		400	
	110 V A	160	200	300		400	
	220 V A	160	200	300		400	
	440 V A	11.5		11			
	600 V A	4		5.2			
Utilization category DC-3/DC-5, shunt-wound and series-wound motors ($L/R \leq 15$ ms)							
• Rated operational currents I_e (at 60 °C)							
- 1 conducting path	Up to 24 V A	160	200	300		400	
	60 V A	7.5		11			
	110 V A	2.5		3			
	220 V A	0.6					
	440 V A	0.17		0.18			
	600 V A	0.12		0.125			
- 2 conducting paths in series	Up to 24 V A	160	200	300		400	
	60 V A	160	200	300		400	
	110 V A	160	200	300		400	
	220 V A	2.5					
	440 V A	0.65					
	600 V A	0.37					
- 3 conducting paths in series	Up to 24 V A	160	200	300		400	
	60 V A	160	200	300		400	
	110 V A	160	200	300		400	
	220 V A	160	200	300		400	
	440 V A	1.4					
	600 V A	0.75					
Switching frequency							
Switching frequency z in operating cycles/hour							
Contactors without overload relays							
• No-load switching frequency							
- Standard operating mechanism	3RT10..-A	1/h	2 000				
- Solid-state operating mechanism	3RT10..-N/-P	1/h	1 000				
	3RT10..-S	1/h	1 000			500	
• Switching frequency z during rated operation ¹⁾							
- 3RT10..-A standard operating mechanism and	$I_e/AC-1$ at 400 V	1/h	800		750	800	750
3RT10..-N/-P solid-state operating mechanism	$I_e/AC-2$ at 400 V	1/h	400	300	250		700
	$I_e/AC-3$ at 400 V	1/h	1 000	750	500		200
	$I_e/AC-4$ at 400 V	1/h	130				500
- 3RT10..-S solid-state operating mechanism	$I_e/AC-1$ at 400 V	1/h	750		500		200
	$I_e/AC-2$ at 400 V	1/h	400	300	250		200
	$I_e/AC-3$ at 400 V	1/h	750		500		200
	$I_e/AC-4$ at 400 V	1/h	130				170
Contactors with mounted overload relay							
• Mean value		1/h	60				

¹⁾ Dependence of the switching frequency z' on the operational current I' and operational voltage U' :
 $z' = z \cdot (I_e/I') \cdot (U_e/U')^{1.5} \cdot 1/h$.

Switching Devices – Contactors and Contactor Assemblies – for Switching Motors

Power Contactors for Switching Motors

SIRIUS 3RT contactors, 3-pole up to 250 kW

Type	Contactors			
Size	3RT105. S6	3RT106. S10	3RT107. S12	
Conductor cross-sections				
Main conductors (1 or 2 conductors can be connected)				
 Screw terminals				
With mounted box terminals	Type	3RT1955-4G (55 kW)	3RT1956-4G	3RT1966-4G
<ul style="list-style-type: none"> Terminal screws Tightening torque 	Nm	M10 (hexagon socket, A/F 4)		M12 (hexagon socket, A/F 5)
	lb.in	10 ... 12		20 ... 22
		90 ... 110		180 ... 195
Front clamping point connected				
 <ul style="list-style-type: none"> Finely stranded with end sleeve (DIN 46228) Finely stranded without end sleeve Stranded AWG cables, solid or stranded Ribbon cable conductors (number x width x thickness) 	mm ²	16 ... 70	16 ... 120	70 ... 240
	mm ²	16 ... 70	16 ... 120	70 ... 240
	mm ²	16 ... 70	16 ... 120	95 ... 300
	AWG	6 ... 2/0	6 ... 250 kcmil	3/0 ... 600 kcmil
	mm	Min. 3 x 9 x 0,8, max. 6 x 15,5 x 0,8	Min. 3 x 9 x 0,8, max. 10 x 15,5 x 0,8	Min. 6 x 9 x 0,8, max. 20 x 24 x 0,5
Rear clamping point connected				
 <ul style="list-style-type: none"> Finely stranded with end sleeve (DIN 46228) Finely stranded without end sleeve Stranded AWG cables, solid or stranded Ribbon cable conductors (number x width x thickness) 	mm ²	16 ... 70	16 ... 120	120 ... 185
	mm ²	16 ... 70	16 ... 120	120 ... 185
	mm ²	16 ... 70	16 ... 120	120 ... 240
	AWG	6 ... 2/0	6 ... 250 kcmil	250 ... 500 kcmil
	mm	Min. 3 x 9 x 0,8, max. 6 x 15,5 x 0,8	Min. 3 x 9 x 0,8, max. 10 x 15,5 x 0,8	Min. 6 x 9 x 0,8, max. 20 x 24 x 0,5
Both clamping points connected (minimum cross-section 16 mm ²)				
 <ul style="list-style-type: none"> Finely stranded with end sleeve (DIN 46228) Finely stranded without end sleeve Stranded AWG cables, solid or stranded Ribbon cable conductors (number x width x thickness) 	mm ²	Max. 1 x 50, 1 x 70	Max. 1 x 95, 1 x 120	Min. 2 x 50, max. 2 x 185
	mm ²	Max. 1 x 50, 1 x 70	Max. 1 x 95, 1 x 120	Min. 2 x 50, max. 2 x 185
	mm ²	Max. 1 x 50, 1 x 70	Max. 1 x 95, 1 x 120	Min. 2 x 70, max. 2 x 240
	AWG	Max. 2 x 1/0	Max. 2 x 3/0	Min. 2 x 2/0, max. 2 x 500 kcmil
	mm	Max. 2 x (6 x 15,5 x 0,8)	Max. 2 x (10 x 15,5 x 0,8)	Max. 2 x (20 x 24 x 0,5)
Busbar connections				
Connecting bar (max. width)	mm	17		25
Cable lug connection				
<ul style="list-style-type: none"> Finely stranded with cable lug¹⁾²⁾ Stranded with cable lug¹⁾²⁾ 	mm ²	16 ... 95		50 ... 240
	mm ²	25 ... 120		70 ... 240
<ul style="list-style-type: none"> AWG cables, solid or stranded 	AWG	4 ... 250 kcmil		2/0 ... 500 kcmil
<ul style="list-style-type: none"> Terminal screws Tightening torque 	Nm	M8 x 25 (A/F 13)		M10 x 30 (A/F 17)
	lb.in	10 ... 14		14 ... 24
		90 ... 124		124 ... 210
Auxiliary conductors (1 or 2 conductors can be connected)				
<ul style="list-style-type: none"> Solid Finely stranded with end sleeve (DIN 46228) 	mm ²	2 x (0,5 ... 1,5) ³⁾ ; 2 x (0,75 ... 2,5) ³⁾ ; max. 2 x (0,75 ... 4) ³⁾		
	mm ²	2 x (0,5 ... 1,5) ³⁾ ; 2 x (0,75 ... 2,5) ³⁾		
<ul style="list-style-type: none"> AWG cables, solid or stranded 	AWG	2 x (18 ... 14)		
<ul style="list-style-type: none"> Terminal screws Tightening torque 	Nm	M3 (Pozidriv size 2)		
	lb.in	0,8 ... 1,2		
		7 ... 10,3		
Auxiliary conductors⁴⁾ (1 or 2 conductors can be connected)				
 Spring-loaded terminals				
<ul style="list-style-type: none"> Operating devices 		3,0 x 0,5; 3,5 x 0,5		
<ul style="list-style-type: none"> Solid Finely stranded with end sleeve (DIN 46228) 	mm ²	2 x (0,25 ... 2,5)		
	mm ²	2 x (0,25 ... 1,5)		
<ul style="list-style-type: none"> Finely stranded without end sleeve 	mm ²	2 x (0,25 ... 2,5)		
<ul style="list-style-type: none"> AWG cables, solid or stranded 	AWG	2 x (24 ... 14)		

¹⁾ 3RT105.: When using cable lugs according to EN 46235, use the 3RT1956-4EA1 terminal cover for conductor cross-sections from 95 mm² to maintain the phase clearance; see page 3/117.

²⁾ 3RT106. and 3RT107.: When connecting cable lugs according to DIN 46234 for conductor cross-sections larger than 240 mm² and according to DIN 46235 for conductor cross-sections larger than 185 mm², the 3RT1966-4EA1 terminal cover is required to maintain the phase clearance; see page 3/117.

³⁾ If two different conductor cross-sections are connected to one clamping point, both cross-sections must lie in one of the ranges specified.

⁴⁾ Max. external diameter of the conductor insulation: 3.6 mm. On spring-loaded terminals with conductor cross-sections ≤ 1 mm² an insulation stop is recommended; see page 3/120.

Switching Devices – Contactors and Contactor Assemblies – for Switching Motors

Power Contactors for Switching Motors

SIRIUS 3RT contactors, 3-pole up to 250 kW

Data for North America

Type Size	Contactors			
	3RT2015 S00	3RT2016	3RT2017	3RT2018
and rated data				
Rated operational voltage	V AC	600		
Uninterrupted current , at 40 °C, open and enclosed	A	20		
Maximum horsepower ratings (from and approved values)				
• Rated power for three-phase motors at 60 Hz	At 200 V hp 230 V hp 460 V hp 575 V hp	1.5 2 3 5	2 3 5 7.5	3 5 7.5 10
Short-circuit protection (contactor)	At 600 V kA	5		
• Class J fuse (values for RK5 fuses available on request)	A	60		
• Circuit breakers in accordance with UL 489 ("Inverse Time Breakers")	A	50		
• Combination Motor Controllers (Type E) acc. to UL 508 and UL 60947-4-1		3RV2.1 or 3RV2.2		

Type Size	Contactors						
	3RT2023 S0	3RT2024	3RT2025	3RT2026	3RT2326-.....4AA0	3RT2027 3RT2028	
and rated data							
Rated operational voltage	V AC	600					
Uninterrupted current , at 40 °C, open and enclosed	A	30					42
Maximum horsepower ratings (from and approved values)							
• Rated power for three-phase motors at 60 Hz	At 200 V hp 230 V hp 460 V hp 575 V hp	2 3 5 7.5	3 7.5 10	5 10 15	5 7.5 15	3 5 10 15	10 10 20 25
Short-circuit protection (contactor)	At 600 V kA	5					
• Class J fuse (values for RK5 fuses available on request)	A	125					150
• Circuit breakers in accordance with UL 489 ("Inverse Time Breakers")	A	70					100
• Combination Motor Controllers (Type E) acc. to UL 508 and UL 60947-4-1	At 480 V Type At 600 V Type	3RV202					

Type Size	Contactors							
	3RT2035 S2	3RT2036, 3RT2336-.....4AA0	3RT2037	3RT2038	3RT2045	3RT2046	3RT2047 S3	
and rated data								
Rated operational voltage	V AC	600						
Uninterrupted current , at 40 °C, open and enclosed	A	55	60	80	90	62	77	99
Maximum horsepower ratings (from and approved values)								
• Rated power for three-phase motors at 60 Hz	At 200/208 V hp 230/240 V hp 460/480 V hp 575/600 V hp	10 15 30 40	15 40 50	20 25 50	25 60 60	25 30 60 75	30 40 75 100	
Short-circuit protection (contactor)	At 600 V kA	5	10			10		
• RK5 fuse	A	150	200	250	300		350	
• Combination Motor Controllers (Type E) acc. to UL 508 and UL 60947-4-1	Type	3RV203		3RV204				

Switching Devices – Contactors and Contactor Assemblies – for Switching Motors

Power Contactors for Switching Motors

SIRIUS 3RT contactors, 3-pole up to 250 kW

Size	Contactors							
	3RT1054 S6	3RT1055	3RT1056	3RT1064 S10	3RT1065	3RT1066	3RT1075 S12	3RT1076
Ⓢ and Ⓤ rated data								
Rated operational voltage	V AC	600						
Uninterrupted current , at 40 °C, open and enclosed	A	140	195	250	330	400	540	
Maximum horsepower ratings (from Ⓢ and Ⓤ approved values)								
• Rated power for three-phase motors at 60 Hz	At 200 V hp	40	50	60	75	100	125	150
	230 V hp	50	60	75	100	125	150	200
	460 V hp	100	125	150	200	250	300	400
	575 V hp	125	150	200	250	300	400	500
Short-circuit protection	More information, see Certificate of Compliance for the individual devices . For the dimensioning of load feeders, see Configuration Manual .							

Type Size	Contactors			
	3RT201 S00	3RT202 to 3RT204 S0 to S3	Mountable auxiliary switch	3RT105 to 3RT107 S6 to S12 Mountable auxiliary switch
Ⓢ and Ⓤ rated data of the auxiliary contacts				
Rated voltage	V AC	600		
Switching capacity		A 600, Q 600	A 600, P 600	A 600, Q 600
• Uninterrupted current at 240 V AC	A	10		

Switching Devices – Contactors and Contactor Assemblies – for Switching Motors

Power Contactors for Switching Motors

SIRIUS 3RT contactors, 3-pole up to 250 kW **IE3/IE4 ready**
Selection and ordering data
AC operation 

 PU (UNIT, SET, M) = 1
 PS* = 1 unit
 PG = 41B

3RT201-1A...



3RT201-2A...



3RT201-1AP04-3MA0



3RT201-2AP04-3MA0

Rated data		Auxiliary contacts		Rated control supply voltage U_s	SD	Screw terminals		SD	Spring-loaded terminals	
AC-2 and AC-3, t_i : 60 °C		AC-1, t_i : 40 °C		50/60 Hz AC	d			d		
Operational current I_e up to 400 V	Ratings of three-phase motors at 50 Hz and 400 V	Operational current I_e up to 690 V	Ident. No.			Version	Article No.		Price per PU	Article No.
A	400 V kW	A	NO NC	V						

For screw fixing and snap-on mounting onto TH 35 standard mounting rail
Size S00

7	3	18	10	1	--	24 110 230	▶	3RT2015-1AB01 3RT2015-1AF01 3RT2015-1AP01	▶	3RT2015-2AB01 3RT2015-2AF01 3RT2015-2AP01
			01	--	1	24 110 230	▶	3RT2015-1AB02 3RT2015-1AF02 3RT2015-1AP02	▶	3RT2015-2AB02 3RT2015-2AF02 3RT2015-2AP02
9	4	22	10	1	--	24 110 230	▶	3RT2016-1AB01 3RT2016-1AF01 3RT2016-1AP01	▶	3RT2016-2AB01 3RT2016-2AF01 3RT2016-2AP01
			01	--	1	24 110 230	▶	3RT2016-1AB02 3RT2016-1AF02 3RT2016-1AP02	▶	3RT2016-2AB02 3RT2016-2AF02 3RT2016-2AP02
12	5.5	22	10	1	--	24 110 230	▶	3RT2017-1AB01 3RT2017-1AF01 3RT2017-1AP01	▶	3RT2017-2AB01 3RT2017-2AF01 3RT2017-2AP01
			01	--	1	24 110 230	▶	3RT2017-1AB02 3RT2017-1AF02 3RT2017-1AP02	▶	3RT2017-2AB02 3RT2017-2AF02 3RT2017-2AP02
16	7.5	22	10	1	--	24 110 230	▶	3RT2018-1AB01 3RT2018-1AF01 3RT2018-1AP01	▶	3RT2018-2AB01 3RT2018-2AF01 3RT2018-2AP01
			01	--	1	24 110 230	▶	3RT2018-1AB02 3RT2018-1AF02 3RT2018-1AP02	▶	3RT2018-2AB02 3RT2018-2AF02 3RT2018-2AP02
With permanently mounted auxiliary switch										
7	3	18	22	2	2	230	2	3RT2015-1AP04-3MA0	5	3RT2015-2AP04-3MA0
9	4	22	22	2	2	230	2	3RT2016-1AP04-3MA0	5	3RT2016-2AP04-3MA0
12	5.5	22	22	2	2	230	2	3RT2017-1AP04-3MA0	5	3RT2017-2AP04-3MA0
16	7.5	22	22	2	2	230	▶	3RT2018-1AP04-3MA0	5	3RT2018-2AP04-3MA0
With permanently mounted auxiliary switch and varistor plugged into the front										
7	3	18	22	2	2	230	5	3RT2015-1CP04-3MA0	5	3RT2015-2CP04-3MA0
9	4	22	22	2	2	230	5	3RT2016-1CP04-3MA0	5	3RT2016-2CP04-3MA0
12	5.5	22	22	2	2	230	5	3RT2017-1CP04-3MA0	5	3RT2017-2CP04-3MA0
16	7.5	22	22	2	2	230	5	3RT2018-1CP04-3MA0	5	3RT2018-2CP04-3MA0

 Other voltages [according to page 3/73](#) on request.

 Accessories and spare parts, [see pages 3/75 to 3/124](#).

Switching Devices – Contactors and Contactor Assemblies – for Switching Motors

Power Contactors for Switching Motors

IE3/IE4 ready

SIRIUS 3RT contactors, 3-pole up to 250 kW

AC operation 





PU (UNIT, SET, M) = 1
 PS* = 1 unit
 PG = 41B



3RT202.-1A.00



3RT202.-2A.00

Rated data		Auxiliary contacts	Rated control supply voltage U_s	SD	Screw terminals 	SD	Spring-loaded terminals 
AC-2 and AC-3, t_u : 60 °C	AC-1, t_u : 40 °C	Ident. No.	50 Hz AC		Article No.		Article No.
Operational current I_e up to 400 V	Ratings of three-phase motors at 50 Hz and up to 690 V	Version			Price per PU		Price per PU
400 V		 					
A	A	NO NC V	d			d	

For screw fixing and snap-on mounting onto TH 35 standard mounting rail

Size S0

9	4	40	11	1	1	24 110 230	▶	3RT2023-1AB00 3RT2023-1AF00 3RT2023-1AP00	2 2 ▶	3RT2023-2AB00 3RT2023-2AF00 3RT2023-2AP00
12	5.5	40	11	1	1	24 110 230	▶	3RT2024-1AB00 3RT2024-1AF00 3RT2024-1AP00	2 2 ▶	3RT2024-2AB00 3RT2024-2AF00 3RT2024-2AP00
17	7.5	40	11	1	1	24 110 230	▶	3RT2025-1AB00 3RT2025-1AF00 3RT2025-1AP00	2 2 ▶	3RT2025-2AB00 3RT2025-2AF00 3RT2025-2AP00
25	11	40	11	1	1	24 110 230	▶	3RT2026-1AB00 3RT2026-1AF00 3RT2026-1AP00	2 2 ▶	3RT2026-2AB00 3RT2026-2AF00 3RT2026-2AP00
32	15	50	11	1	1	24 110 230	▶	3RT2027-1AB00 3RT2027-1AF00 3RT2027-1AP00	2 2 ▶	3RT2027-2AB00 3RT2027-2AF00 3RT2027-2AP00
38	18.5	50	11	1	1	24 110 230	▶	3RT2028-1AB00 3RT2028-1AF00 3RT2028-1AP00	2 2 2	3RT2028-2AB00 3RT2028-2AF00 3RT2028-2AP00

Other voltages [according to page 3/73](#) on request.

Accessories and spare parts, see [pages 3/75 to 3/124](#).

Switching Devices – Contactors and Contactor Assemblies – for Switching Motors

Power Contactors for Switching Motors

SIRIUS 3RT contactors, 3-pole up to 250 kW **IE3/IE4 ready**
AC operation 

 PU (UNIT, SET, M) = 1
 PS* = 1 unit
 PG = 41B



3RT202.-1A.04



3RT202.-2A.04

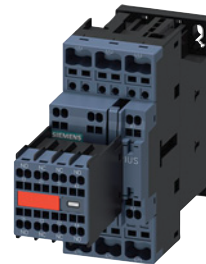

3RT202.-1CL24-3MA0



3RT202.-2CL24-3MA0

Rated data		Auxiliary contacts		Rated control supply voltage	SD	Screw terminals		SD	Spring-loaded terminals	
AC-2 and AC-3, t_{ij} : 60 °C	AC-1, t_{ij} : 40 °C	Ident. No.	Version	U_s						
Operational current I_e up to 400 V	Ratings of three-phase motors at 50 Hz and 690 V			50 Hz AC		Article No.	Price per PU		Article No.	Price per PU
400 V	400 V									
A	kW	A	NO NC V	d				d		

For screw fixing and snap-on mounting onto TH 35 standard mounting rail

Size S0
With removable auxiliary switch

9	4	40	22	2	2	24 230	5	3RT2023-1AB04 3RT2023-1AP04	5 2	3RT2023-2AB04 3RT2023-2AP04
12	5.5	40	22	2	2	24 110 230	5 5 ▶	3RT2024-1AB04 3RT2024-1AF04 3RT2024-1AP04	5 5 2	3RT2024-2AB04 3RT2024-2AF04 3RT2024-2AP04
17	7.5	40	22	2	2	24 110 230	5 5 ▶	3RT2025-1AB04 3RT2025-1AF04 3RT2025-1AP04	5 5 2	3RT2025-2AB04 3RT2025-2AF04 3RT2025-2AP04
25	11	40	22	2	2	24 110 230	5 5 ▶	3RT2026-1AB04 3RT2026-1AF04 3RT2026-1AP04	5 5 2	3RT2026-2AB04 3RT2026-2AF04 3RT2026-2AP04
32	15	50	22	2	2	24 110 230	5 5 ▶	3RT2027-1AB04 3RT2027-1AF04 3RT2027-1AP04	5 5 2	3RT2027-2AB04 3RT2027-2AF04 3RT2027-2AP04
38	18.5	50	22	2	2	24 110 230	5 5 ▶	3RT2028-1AB04 3RT2028-1AF04 3RT2028-1AP04	5 5 2	3RT2028-2AB04 3RT2028-2AF04 3RT2028-2AP04

With permanently mounted auxiliary switch and varistor plugged in

9	4	40	22	2	2	230	5	3RT2023-1CL24-3MA0	5	3RT2023-2CL24-3MA0
12	5.5	40	22	2	2	230	2	3RT2024-1CL24-3MA0	5	3RT2024-2CL24-3MA0
17	7.5	40	22	2	2	230	5	3RT2025-1CL24-3MA0	5	3RT2025-2CL24-3MA0
25	11	40	22	2	2	230	5	3RT2026-1CL24-3MA0	5	3RT2026-2CL24-3MA0
32	15	50	22	2	2	230	5	3RT2027-1CL24-3MA0	5	3RT2027-2CL24-3MA0
38	18.5	50	22	2	2	230	5	3RT2028-1CL24-3MA0	5	3RT2028-2CL24-3MA0

 Other voltages [according to page 3/73](#) on request.

 Accessories and spare parts, [see pages 3/75 to 3/124](#).

Switching Devices – Contactors and Contactor Assemblies – for Switching Motors

Power Contactors for Switching Motors

IE3/IE4 ready

SIRIUS 3RT contactors, 3-pole up to 250 kW

AC operation 

PU (UNIT, SET, M) = 1
 PS* = 1 unit
 PG = 41B



3RT203-1A.00



3RT203-3A.00







3RT203-1A.04



3RT203-1CL24-3MA0



3RT203-3CL24-3MA0

Rated data		Auxiliary contacts	Rated control supply voltage U_s	SD	Screw terminals	SD	Spring-loaded terminals
AC-2 and AC-3, t_j : 60 °C	AC-1, t_j : 40 °C	Ident. No.	50 Hz AC				
Operational current I_e up to 400 V	Operational current I_e up to 690 V	Version			Article No.	Price per PU	Article No.
Ratings of three-phase motors at 50 Hz and 400 V		 					
A	A	NO NC	V	d			
kW							

For screw fixing and snap-on mounting onto TH 35 standard mounting rail

Size S2

40	18.5	60	11	1	1	24 110 230	▶	3RT2035-1AB00 3RT2035-1AF00 3RT2035-1AP00	2 5 ▶	3RT2035-3AB00 3RT2035-3AF00 3RT2035-3AP00	
50	22	70	11	1	1	24 110 230	▶	3RT2036-1AB00 3RT2036-1AF00 3RT2036-1AP00	5 5 ▶	3RT2036-3AB00 3RT2036-3AF00 3RT2036-3AP00	
65	30	80	11	1	1	24 110 230	▶	3RT2037-1AB00 3RT2037-1AF00 3RT2037-1AP00	5 5 ▶	3RT2037-3AB00 3RT2037-3AF00 3RT2037-3AP00	
80	37	90	11	1	1	24 110 230	▶	3RT2038-1AB00 3RT2038-1AF00 3RT2038-1AP00	2 2 ▶	3RT2038-3AB00 3RT2038-3AF00 3RT2038-3AP00	
With removable auxiliary switch											
40	18.5	60	22	2	2	24 110 230	▶	3RT2035-1AB04 3RT2035-1AF04 3RT2035-1AP04	2 2 ▶	-- -- --	
50	22	70	22	2	2	24 110 230	▶	3RT2036-1AB04 3RT2036-1AF04 3RT2036-1AP04	2 2 ▶	-- -- --	
65	30	80	22	2	2	24 110 230	▶	3RT2037-1AB04 3RT2037-1AF04 3RT2037-1AP04	2 2 ▶	-- -- --	
80	37	90	22	2	2	24 110 230	▶	3RT2038-1AB04 3RT2038-1AF04 3RT2038-1AP04	5 2 ▶	-- -- --	
With permanently mounted auxiliary switch and integrated coil circuit (varistor plugged in at the factory)											
40	18.5	60	22	2	2	230		3RT2035-1CL24-3MA0	5	3RT2035-3CL24-3MA0	
50	22	70	22	2	2	230		3RT2036-1CL24-3MA0	5	3RT2036-3CL24-3MA0	
65	30	80	22	2	2	230		3RT2037-1CL24-3MA0	5	3RT2037-3CL24-3MA0	
80	37	90	22	2	2	230		3RT2038-1CL24-3MA0	5	3RT2038-3CL24-3MA0	

Other voltages according to page 3/73 on request.

Accessories and spare parts, see pages 3/75 to 3/124.

Switching Devices – Contactors and Contactor Assemblies – for Switching Motors

Power Contactors for Switching Motors

SIRIUS 3RT contactors, 3-pole up to 250 kW **IE3/IE4 ready**
AC operation 

 PU (UNIT, SET, M) = 1
 PS* = 1 unit
 PG = 41B

3RT204.-1A.00





3RT204.-1A.04



3RT204.-1CL24-3MA0



3RT204.-3A.00

Rated data		Auxiliary contacts	Rated control supply voltage U_s	SD	Screw terminals 	SD	Spring-loaded terminals 	
AC-2 and AC-3, t_u : 60 °C	AC-1, t_u : 40 °C	Ident. No.	50 Hz AC		Article No.	Price per PU	Article No.	Price per PU
Operational current I_e up to 400 V	Operational current I_e up to 690 V	Version						
Ratings of three-phase motors at 50 Hz and 400 V		NO NC V						
A	A			d				
kW								

For screw fixing and snap-on mounting onto TH 35-15 and TH 75-15 standard mounting rails
Size S3

80	37	125	11	1	1	24 110 230	2 2 ▶	3RT2045-1AB00 3RT2045-1AF00 3RT2045-1AP00	5 5 2	3RT2045-3AB00 3RT2045-3AF00 3RT2045-3AP00
95	45	130	11	1	1	24 110 230	2 2 ▶	3RT2046-1AB00 3RT2046-1AF00 3RT2046-1AP00	5 5 2	3RT2046-3AB00 3RT2046-3AF00 3RT2046-3AP00
110	55	130	11	1	1	24 110 230	5 5 ▶	3RT2047-1AB00 3RT2047-1AF00 3RT2047-1AP00	5 5 5	3RT2047-3AB00 3RT2047-3AF00 3RT2047-3AP00
With removable auxiliary switch										
80	37	125	22	2	2	24 110 230	5 2 2	3RT2045-1AB04 3RT2045-1AF04 3RT2045-1AP04		-- -- --
95	45	130	22	2	2	24 110 230	5 2 2	3RT2046-1AB04 3RT2046-1AF04 3RT2046-1AP04		-- -- --
110	55	130	22	2	2	24 110 230	5 5 5	3RT2047-1AB04 3RT2047-1AF04 3RT2047-1AP04		-- -- --
With permanently mounted auxiliary switch and integrated coil circuit (varistor plugged in at the factory)										
80	37	125	22	2	2	230	5	3RT2045-1CL24-3MA0		--
95	45	130	22	2	2	230	5	3RT2046-1CL24-3MA0		--
110	55	130	22	2	2	230	5	3RT2047-1CL24-3MA0		--

 Other voltages [according to page 3/73](#) on request.

 Accessories and spare parts, [see pages 3/75 to 3/124](#).

Switching Devices – Contactors and Contactor Assemblies – for Switching Motors

Power Contactors for Switching Motors

IE3/IE4 ready

SIRIUS 3RT contactors, 3-pole up to 250 kW

DC operation 

PU (UNIT, SET, M) = 1
 PS* = 1 unit
 PG = 41B



3RT201-1B...



3RT201-2B...

Rated data		Auxiliary contacts		Rated control supply voltage	SD	Screw terminals		SD	Spring-loaded terminals	
AC-2 and AC-3, t_U : 60 °C		AC-1, t_U : 40 °C		U_s DC	d					
Operational current I_e up to 400 V	Ratings of three-phase motors at 50 Hz and 400 V	Operational current I_e up to 690 V	Ident. No.			Version	Article No.		Price per PU	Article No.
A	kW	A		V						
			NO	NC						

For screw fixing and snap-on mounting onto TH 35 standard mounting rail

Size S00

7	3	18	10	1	--	24 220	▶	3RT2015-1BB41 3RT2015-1BM41	▶	3RT2015-2BB41 3RT2015-2BM41
			01	--	1	24 220	▶	3RT2015-1BB42 3RT2015-1BM42	▶	3RT2015-2BB42 3RT2015-2BM42
9	4	22	10	1	--	24 220	▶	3RT2016-1BB41 3RT2016-1BM41	▶	3RT2016-2BB41 3RT2016-2BM41
			01	--	1	24 220	▶	3RT2016-1BB42 3RT2016-1BM42	▶	3RT2016-2BB42 3RT2016-2BM42
12	5.5	22	10	1	--	24 220	▶	3RT2017-1BB41 3RT2017-1BM41	▶	3RT2017-2BB41 3RT2017-2BM41
			01	--	1	24 220	▶	3RT2017-1BB42 3RT2017-1BM42	▶	3RT2017-2BB42 3RT2017-2BM42
16	7.5	22	10	1	--	24 220	▶	3RT2018-1BB41 3RT2018-1BM41	▶	3RT2018-2BB41 3RT2018-2BM41
			01	--	1	24 220	▶	3RT2018-1BB42 3RT2018-1BM42	▶	3RT2018-2BB42 3RT2018-2BM42
With integrated coil circuit (varistor integrated at the factory)										
7	3	18	10	1	--	24 220	▶	3RT2015-1UB41 3RT2015-1UB42	▶	3RT2015-2UB41 3RT2015-2UB42
			01	--	1	24 220	▶	3RT2015-1UB42 3RT2015-1UB42	▶	3RT2015-2UB42 3RT2015-2UB42
9	4	22	10	1	--	24 220	▶	3RT2016-1UB41 3RT2016-1UB42	▶	3RT2016-2UB41 3RT2016-2UB42
			01	--	1	24 220	▶	3RT2016-1UB42 3RT2016-1UB42	▶	3RT2016-2UB42 3RT2016-2UB42
12	5.5	22	10	1	--	24 220	▶	3RT2017-1UB41 3RT2017-1UB42	▶	3RT2017-2UB41 3RT2017-2UB42
			01	--	1	24 220	▶	3RT2017-1UB42 3RT2017-1UB42	▶	3RT2017-2UB42 3RT2017-2UB42
16	7.5	22	10	1	--	24 220	▶	3RT2018-1UB41 3RT2018-1UB42	▶	3RT2018-2UB41 3RT2018-2UB42
			01	--	1	24 220	▶	3RT2018-1UB42 3RT2018-1UB42	▶	3RT2018-2UB42 3RT2018-2UB42
With integrated coil circuit (diode integrated at the factory)¹⁾										
7	3	18	10	1	--	24 220	▶	3RT2015-1FB41 3RT2015-1FB42	▶	3RT2015-2FB41 3RT2015-2FB42
			01	--	1	24 220	▶	3RT2015-1FB42 3RT2015-1FB42	▶	3RT2015-2FB42 3RT2015-2FB42
9	4	22	10	1	--	24 220	▶	3RT2016-1FB41 3RT2016-1FB42	▶	3RT2016-2FB41 3RT2016-2FB42
			01	--	1	24 220	▶	3RT2016-1FB42 3RT2016-1FB42	▶	3RT2016-2FB42 3RT2016-2FB42
12	5.5	22	10	1	--	24 220	▶	3RT2017-1FB41 3RT2017-1FB42	▶	3RT2017-2FB41 3RT2017-2FB42
			01	--	1	24 220	▶	3RT2017-1FB42 3RT2017-1FB42	▶	3RT2017-2FB42 3RT2017-2FB42
16	7.5	22	10	1	--	24 220	▶	3RT2018-1FB41 3RT2018-1FB42	▶	3RT2018-2FB41 3RT2018-2FB42
			01	--	1	24 220	▶	3RT2018-1FB42 3RT2018-1FB42	▶	3RT2018-2FB42 3RT2018-2FB42

¹⁾ When using contactors with IE3/IE4 motors, use contactors fitted with varistors instead of diodes.
 For more information about dimensioning and configuring, see page 3/7.

Other voltages according to page 3/73 on request.

Accessories and spare parts, see pages 3/75 to 3/124.

Switching Devices – Contactors and Contactor Assemblies – for Switching Motors

Power Contactors for Switching Motors

SIRIUS 3RT contactors, 3-pole up to 250 kW **IE3/IE4 ready**
DC operation

 PU (UNIT, SET, M) = 1
 PS* = 1 unit
 PG = 41B

3RT201.-1BB44-3MA0



3RT201.-2BB44-3MA0



3RT201.-1BB4.-0CC0



3RT201.-2BB4.-0CC0

Rated data		Auxiliary contacts	Rated control supply voltage U_s	SD	Screw terminals	SD	Spring-loaded terminals
AC-2 and AC-3, t_u : 60 °C	AC-1, t_u : 40 °C	Ident. No.	DC		⊕		⊕
Operational current I_e up to 400 V	Operational current I_e up to 690 V	Version			Article No.	Price per PU	Article No.
Ratings of three-phase motors at 50 Hz and 400 V		NO NC V		d			Price per PU
A	A						
kW							

For screw fixing and snap-on mounting onto TH 35 standard mounting rail
Size S00
With permanently mounted auxiliary switch

7	3	18	22	2	2	24		3RT2015-1BB44-3MA0	2	3RT2015-2BB44-3MA0
9	4	22	22	2	2	24	▶	3RT2016-1BB44-3MA0	2	3RT2016-2BB44-3MA0
12	5.5	22	22	2	2	24	2	3RT2017-1BB44-3MA0	2	3RT2017-2BB44-3MA0
16	7.5	22	22	2	2	24	2	3RT2018-1BB44-3MA0	2	3RT2018-2BB44-3MA0

With permanently mounted auxiliary switch and integrated coil circuit (diode integrated at the factory)¹⁾

7	3	18	22	2	2	24	2	3RT2015-1FB44-3MA0	2	3RT2015-2FB44-3MA0
9	4	22	22	2	2	24	2	3RT2016-1FB44-3MA0	2	3RT2016-2FB44-3MA0
12	5.5	22	22	2	2	24	2	3RT2017-1FB44-3MA0	5	3RT2017-2FB44-3MA0
16	7.5	22	22	2	2	24	2	3RT2018-1FB44-3MA0	2	3RT2018-2FB44-3MA0

With voltage tap-off (only available with 24 V DC coils)

7	3	18	10	1	--	24	▶	3RT2015-1BB41-0CC0	▶	3RT2015-2BB41-0CC0
			01	--	1	24	▶	3RT2015-1BB42-0CC0	2	3RT2015-2BB42-0CC0
9	4	22	10	1	--	24	▶	3RT2016-1BB41-0CC0	2	3RT2016-2BB41-0CC0
			01	--	1	24	2	3RT2016-1BB42-0CC0	2	3RT2016-2BB42-0CC0
12	5.5	22	10	1	--	24	2	3RT2017-1BB41-0CC0	▶	3RT2017-2BB41-0CC0
			01	--	1	24	5	3RT2017-1BB42-0CC0	▶	3RT2017-2BB42-0CC0
16	7.5	22	10	1	--	24	2	3RT2018-1BB41-0CC0	▶	3RT2018-2BB41-0CC0
			01	--	1	24	2	3RT2018-1BB42-0CC0	2	3RT2018-2BB42-0CC0

¹⁾ When using contactors with IE3/IE4 motors, use contactors fitted with varistors instead of diodes.
For more information about dimensioning and configuring, see page 3/7.

Other voltages according to page 3/73 on request.

Accessories and spare parts, see pages 3/75 to 3/124.

Switching Devices – Contactors and Contactor Assemblies – for Switching Motors

Power Contactors for Switching Motors

IE3/IE4 ready

SIRIUS 3RT contactors, 3-pole up to 250 kW

DC operation for direct control by PLC

- Coupling contactors with adapted power consumption
- Suitable for electronic PLC/F-PLC outputs
- Cannot be expanded with auxiliary switches



PU (UNIT, SET, M) = 1
 PS* = 1 unit
 PG = 41B



3RT201-1.B4.



3RT201-2.B4.

Rated data		Auxiliary contacts		Rated control supply voltage U_s	SD	Screw terminals 		SD	Spring-loaded terminals 	
AC-2 and AC-3, t_u : 60 °C	AC-1, t_u : 40 °C	Ident. No.	Version	DC		Article No.	Price per PU		Article No.	Price per PU
Operational current I_e up to 400 V	Ratings of three-phase motors at 50 Hz and 400 V									
A	kW	A	NO NC	V	d			d		

For screw fixing and snap-on mounting onto TH 35 standard mounting rail

Size S00

(Cannot be expanded with auxiliary switches)

Operating range $0.7 \dots 1.25 \times U_s$,

power consumption of the solenoid coils **2.8 W** at 24 V

7	3	18	10 01	1 -- 1	24 24	5 5	3RT2015-1HB41 3RT2015-1HB42	5 5	3RT2015-2HB41 3RT2015-2HB42
9	4	22	10 01	1 -- 1	24 24	5 2	3RT2016-1HB41 3RT2016-1HB42	5 5	3RT2016-2HB41 3RT2016-2HB42
12	5.5¹⁾	22	10 01	1 -- 1	24 24	5 ▶ 5	3RT2017-1HB41 3RT2017-1HB42	5 5	3RT2017-2HB41 3RT2017-2HB42

Operating range $0.85 \dots 1.85 \times U_s$,

power consumption of the solenoid coils **1.6 W** at 24 V

7	3	18	10 01	1 -- 1	24 24	5 5	3RT2015-1MB41-0KT0 3RT2015-1MB42-0KT0	5 5	3RT2015-2MB41-0KT0 3RT2015-2MB42-0KT0
9	4	22	10 01	1 -- 1	24 24	5 5	3RT2016-1MB41-0KT0 3RT2016-1MB42-0KT0	5 5	3RT2016-2MB41-0KT0 3RT2016-2MB42-0KT0
12	5.5¹⁾	22	10 01	1 -- 1	24 24	5 5	3RT2017-1MB41-0KT0 3RT2017-1MB42-0KT0	5 5	3RT2017-2MB41-0KT0 3RT2017-2MB42-0KT0

With integrated coil circuit (diode integrated at the factory)¹⁾

(Cannot be expanded with auxiliary switches)

Operating range $0.7 \dots 1.25 \times U_s$,

power consumption of the solenoid coils **2.8 W** at 24 V

7	3	18	10 01	1 -- 1	24 24	2 2	3RT2015-1JB41 3RT2015-1JB42	2 5	3RT2015-2JB41 3RT2015-2JB42
9	4	22	10 01	1 -- 1	24 24	▶ 2	3RT2016-1JB41 3RT2016-1JB42	5 5	3RT2016-2JB41 3RT2016-2JB42
12	5.5¹⁾	22	10 01	1 -- 1	24 24	2 5	3RT2017-1JB41 3RT2017-1JB42	5 5	3RT2017-2JB41 3RT2017-2JB42

Operating range $0.85 \dots 1.85 \times U_s$,

power consumption of the solenoid coils **1.6 W** at 24 V

7	3	18	10 01	1 -- 1	24 24	5 5	3RT2015-1VB41 3RT2015-1VB42	5 5	3RT2015-2VB41 3RT2015-2VB42
9	4	22	10 01	1 -- 1	24 24	5 5	3RT2016-1VB41 3RT2016-1VB42	5 5	3RT2016-2VB41 3RT2016-2VB42
12	5.5¹⁾	22	10 01	1 -- 1	24 24	5 5	3RT2017-1VB41 3RT2017-1VB42	5 5	3RT2017-2VB41 3RT2017-2VB42

¹⁾ When using contactors with IE3/IE4 motors, use contactors fitted with varistors instead of diodes. In the case of 5.5 kW coupling contactors of size S00, use 5.5 kW coupling contactors of size S0, see page 3/65. For more information about dimensioning and configuring, see page 3/7.

Other voltages according to page 3/73 on request.

Accessories and spare parts, see pages 3/75 to 3/124.

Switching Devices – Contactors and Contactor Assemblies – for Switching Motors

Power Contactors for Switching Motors

SIRIUS 3RT contactors, 3-pole up to 250 kW **IE3/IE4 ready**

DC operation for direct control by PLC

- Coupling contactors with adapted power consumption
- Suitable for electronic PLC/F-PLC outputs
- Cannot be expanded with auxiliary switches





PU (UNIT, SET, M) = 1
 PS* = 1 unit
 PG = 41B



3RT201.-1.B4.



3RT201.-2.B4.

Rated data		Auxiliary contacts		Rated control supply voltage U_s	SD	Screw terminals 		Spring-loaded terminals 	
AC-2 and AC-3, t_i : 60 °C	AC-1, t_i : 40 °C	Ident. No.	Version			DC	Article No.	Price per PU	Article No.
Operational current I_e up to 400 V	Ratings of three-phase motors at 50 Hz and 400 V	Operational current I_e up to 690 V	 	V	d	d	d	d	d
A	kW	A	NO NC	V	d	d	d	d	d

For screw fixing and snap-on mounting onto TH 35 standard mounting rail

Size S00

With integrated coil circuit (suppressor diode integrated at the factory)¹⁾

(Cannot be expanded with auxiliary switches)

Operating range **0.7 ... 1.25 x U_s**

power consumption of the solenoid coils **2.8 W** at 24 V

7	3	18	10 01	1 --	-- 1	24 24	2 2	3RT2015-1KB41 3RT2015-1KB42	2 ▶	3RT2015-2KB41 3RT2015-2KB42
9	4	22	10 01	1 --	-- 1	24 24	2 2	3RT2016-1KB41 3RT2016-1KB42	2 ▶	3RT2016-2KB41 3RT2016-2KB42
12	5.5¹⁾	22	10 01	1 --	-- 1	24 24	2 2	3RT2017-1KB41 3RT2017-1KB42	▶ ▶	3RT2017-2KB41 3RT2017-2KB42
Operating range 0.85 ... 1.85 x U_s										
power consumption of the solenoid coils 1.6 W at 24 V										
7	3	18	10 01	1 --	-- 1	24 24	5 5	3RT2015-1SB41 3RT2015-1SB42	5 5	3RT2015-2SB41 3RT2015-2SB42
9	4	22	10 01	1 --	-- 1	24 24	5 5	3RT2016-1SB41 3RT2016-1SB42	5 5	3RT2016-2SB41 3RT2016-2SB42
12	5.5¹⁾	22	10 01	1 --	-- 1	24 24	5 5	3RT2017-1SB41 3RT2017-1SB42	5 5	3RT2017-2SB41 3RT2017-2SB42

¹⁾ When using contactors with IE3/IE4 motors, use contactors fitted with varistors instead of diodes. In the case of 5.5 kW coupling contactors of size S00, use 5.5 kW coupling contactors of size S0, see page 3/65. For more information about dimensioning and configuring, see page 3/7.

Other voltages according to page 3/73 on request.

Accessories and spare parts, see pages 3/75 to 3/124.

Switching Devices – Contactors and Contactor Assemblies – for Switching Motors

Power Contactors for Switching Motors

IE3/IE4 ready

SIRIUS 3RT contactors, 3-pole up to 250 kW

DC operation 

PU (UNIT, SET, M) = 1
 PS* = 1 unit
 PG = 41B



3RT202.-1B.40



3RT202.-2B.40



3RT202.-1B.44



3RT202.-2B.44

Rated data		Auxiliary contacts	Rated control supply voltage	SD	Screw terminals	SD	Spring-loaded terminals
AC-2 and AC-3, t_u : 60 °C	AC-1, t_u : 40 °C	Ident. No.	DC		Article No.	Price per PU	Article No.
Operational current I_e up to 400 V	Operational current I_e up to 690 V	Version					Price per PU
400 V		NO NC	V	d			
A	kW	A					

For screw fixing and snap-on mounting onto TH 35 standard mounting rail

Size S0

9	4	40	11	1	1	24	▶	3RT2023-1BB40	▶	3RT2023-2BB40
12	5.5	40	11	1	1	24 220	▶	3RT2024-1BB40 3RT2024-1BM40	▶	3RT2024-2BB40 3RT2024-2BM40
17	7.5	40	11	1	1	24 220	▶	3RT2025-1BB40 3RT2025-1BM40	▶	3RT2025-2BB40 3RT2025-2BM40
25	11	40	11	1	1	24 220	▶	3RT2026-1BB40 3RT2026-1BM40	▶	3RT2026-2BB40 3RT2026-2BM40
32	15	50	11	1	1	24 220	▶	3RT2027-1BB40 3RT2027-1BM40	▶	3RT2027-2BB40 3RT2027-2BM40
38	18.5	50	11	1	1	24 220	▶	3RT2028-1BB40 3RT2028-1BM40	▶	3RT2028-2BB40 3RT2028-2BM40
With coil circuit plugged into front (varistor plugged in at the factory)										
9	4	40	11	1	1	24	5	3RT2023-1DB40	5	3RT2023-2DB40
12	5.5	40	11	1	1	24	5	3RT2024-1DB40	5	3RT2024-2DB40
17	7.5	40	11	1	1	24	5	3RT2025-1DB40	5	3RT2025-2DB40
25	11	40	11	1	1	24	5	3RT2026-1DB40	5	3RT2026-2DB40
32	15	50	11	1	1	24	5	3RT2027-1DB40	5	3RT2027-2DB40
38	18.5	50	11	1	1	24	5	3RT2028-1DB40	5	3RT2028-2DB40
With coil circuit plugged into front (diode assembly plugged in at the factory)										
9	4	40	11	1	1	24	2	3RT2023-1FB40	▶	3RT2023-2FB40
12	5.5	40	11	1	1	24	▶	3RT2024-1FB40	▶	3RT2024-2FB40
17	7.5	40	11	1	1	24	▶	3RT2025-1FB40	▶	3RT2025-2FB40
25	11	40	11	1	1	24	▶	3RT2026-1FB40	▶	3RT2026-2FB40
32	15	50	11	1	1	24	▶	3RT2027-1FB40	▶	3RT2027-2FB40
38	18.5	50	11	1	1	24	▶	3RT2028-1FB40	▶	3RT2028-2FB40
With removable auxiliary switch										
9	4	40	22	2	2	24	▶	3RT2023-1BB44	▶	3RT2023-2BB44
12	5.5	40	22	2	2	24	▶	3RT2024-1BB44	▶	3RT2024-2BB44
17	7.5	40	22	2	2	24	▶	3RT2025-1BB44	▶	3RT2025-2BB44
25	11	40	22	2	2	24	▶	3RT2026-1BB44	▶	3RT2026-2BB44
32	15	50	22	2	2	24	▶	3RT2027-1BB44	▶	3RT2027-2BB44
38	18.5	50	22	2	2	24	▶	3RT2028-1BB44	▶	3RT2028-2BB44

Other voltages according to page 3/73 on request.

Accessories and spare parts, see pages 3/75 to 3/124.

Switching Devices – Contactors and Contactor Assemblies – for Switching Motors

Power Contactors for Switching Motors

SIRIUS 3RT contactors, 3-pole up to 250 kW **IE3/IE4 ready**
DC operation

PU (UNIT, SET, M) = 1
 PS* = 1 unit
 PG = 41B



3RT202.-1.B44-3MA0



3RT202.-2.B44-3MA0



3RT202.-1BB40-0CC0



3RT202.-2BB40-0CC0

Rated data		Auxiliary contacts	Rated control supply voltage U_s	SD	Screw terminals	SD	Spring-loaded terminals	
AC-2 and AC-3, t_j : 60 °C	AC-1, t_j : 40 °C	Ident. No.	DC					
Operational current I_e up to 400 V	Operational current I_e up to 690 V	Version			Article No.	Price per PU	Article No.	Price per PU
400 V	690 V	NO NC	V	d				
A	A							
kW								

For screw fixing and snap-on mounting onto TH 35 standard mounting rail

Size S0

With permanently mounted auxiliary switch and integrated coil circuit (varistor integrated at the factory)

12	5.5	40	22	2	2	24	2	3RT2024-1DB44-3MA0	5	3RT2024-2DB44-3MA0
17	7.5	40	22	2	2	24	5	3RT2025-1DB44-3MA0	5	3RT2025-2DB44-3MA0
25	11	40	22	2	2	24	5	3RT2026-1DB44-3MA0	5	3RT2026-2DB44-3MA0
32	15	50	22	2	2	24	5	3RT2027-1DB44-3MA0	5	3RT2027-2DB44-3MA0

With permanently mounted auxiliary switch and integrated coil circuit (diode assembly plugged in at the factory)

9	4	40	22	2	2	24	2	3RT2023-1FB44-3MA0	5	3RT2023-2FB44-3MA0
12	5.5	40	22	2	2	24	5	3RT2024-1FB44-3MA0	5	3RT2024-2FB44-3MA0
17	7.5	40	22	2	2	24	5	3RT2025-1FB44-3MA0	5	3RT2025-2FB44-3MA0
25	11	40	22	2	2	24	5	3RT2026-1FB44-3MA0	5	3RT2026-2FB44-3MA0
32	15	50	22	2	2	24	5	3RT2027-1FB44-3MA0	5	3RT2027-2FB44-3MA0
38	18.5	50	22	2	2	24	5	3RT2028-1FB44-3MA0	5	3RT2028-2FB44-3MA0

With voltage tap-off

9	4	40	11	1	1	24	5	3RT2023-1BB40-0CC0	5	3RT2023-2BB40-0CC0
12	5.5	40	11	1	1	24	5	3RT2024-1BB40-0CC0	5	3RT2024-2BB40-0CC0
17	7.5	40	11	1	1	24	5	3RT2025-1BB40-0CC0	5	3RT2025-2BB40-0CC0
25	11	40	11	1	1	24	5	3RT2026-1BB40-0CC0	5	3RT2026-2BB40-0CC0
32	15	50	11	1	1	24	5	3RT2027-1BB40-0CC0	5	3RT2027-2BB40-0CC0
38	18.5	50	11	1	1	24	5	3RT2028-1BB40-0CC0	5	3RT2028-2BB40-0CC0

Other voltages according to page 3/73 on request.

Accessories and spare parts, see pages 3/75 to 3/124.

Switching Devices – Contactors and Contactor Assemblies – for Switching Motors

Power Contactors for Switching Motors

IE3/IE4 ready

SIRIUS 3RT contactors, 3-pole up to 250 kW

DC operation for direct control by PLC

- Coupling contactors with adapted power consumption
- Suitable for electronic PLC/F-PLC outputs
- Cannot be expanded with auxiliary switches



PU (UNIT, SET, M) = 1
 PS* = 1 unit
 PG = 41B



3RT202.-1KB40



3RT202.-2KB40

Rated data		Auxiliary contacts		Rated control supply voltage U_s	SD	Screw terminals 		SD	Spring-loaded terminals 	
AC-2 and AC-3, t_u : 60 °C	Operational current I_e up to 400 V	AC-1, t_u : 40 °C	Operational current I_e up to 690 V	DC		Article No.	Price per PU		Article No.	Price per PU
	400 V									
A	kW	A			d			d		

For screw fixing and snap-on mounting onto TH 35 standard mounting rail

Size S0

With integrated coil circuit (varistor integrated in electronics at the factory)

(Cannot be expanded with auxiliary switches)

Operating range **0.7 ... 1.25 x U_s** ,
 power consumption of the solenoid coils **4.5 W** at 24 V

9	4	40	11	1	1	24	▶	3RT2023-1KB40	▶	3RT2023-2KB40
12	5.5	40	11	1	1	24	▶	3RT2024-1KB40	5	3RT2024-2KB40
17	7.5	40	11	1	1	24	▶	3RT2025-1KB40	2	3RT2025-2KB40
25	11	40	11	1	1	24	▶	3RT2026-1KB40	2	3RT2026-2KB40
32	15	50	11	1	1	24	▶	3RT2027-1KB40	5	3RT2027-2KB40

Other voltages [according to page 3/73](#) on request.

Accessories and spare parts, [see pages 3/75 to 3/124](#).

Switching Devices – Contactors and Contactor Assemblies – for Switching Motors

Power Contactors for Switching Motors

SIRIUS 3RT contactors, 3-pole up to 250 kW **IE3/IE4 ready**

DC operation for direct control by PLC **==**

- Coupling contactors with adapted power consumption
- Suitable for electronic PLC/F-PLC outputs with 2 A
- Can be expanded using front or lateral auxiliary switch (1 x left and 1 x right)

PU (UNIT, SET, M) = 1
 PS* = 1 unit
 PG = 41B



3RT203.-1KB40



3RT203.-3KB40



3RT204.-1KB40



3RT204.-3KB40

Rated data		Auxiliary contacts	Rated control supply voltage U_s	SD	Screw terminals	SD	Spring-loaded terminals	
AC-2 and AC-3, t_{ij} : 60 °C	AC-1, t_{ij} : 40 °C	Ident. No.	DC		Article No.	Price per PU	Article No.	Price per PU
Operational current I_e up to 400 V	Operational current I_e up to 690 V	Version						
		NO NC V						
A	A							
kW								

For screw fixing and snap-on mounting onto TH 35 standard mounting rail

Size S2

With integrated coil circuit (varistor integrated in electronics at the factory)

Operating range $0.8 \dots 1.2 \times U_s$,
 closing power of the solenoid coils **21.5 W** at 24 V

40	18.5	60	11	1	1	24	▶	3RT2035-1KB40	▶	3RT2035-3KB40
50	22	70	11	1	1	24	▶	3RT2036-1KB40	▶	3RT2036-3KB40
65	30	80	11	1	1	24	▶	3RT2037-1KB40	▶	3RT2037-3KB40
80	37	90	11	1	1	24	▶	3RT2038-1KB40	5	3RT2038-3KB40

For screw fixing and snap-on mounting onto TH 35-15 and TH 75-15 standard mounting rails

Size S3

With integrated coil circuit (varistor integrated in electronics at the factory)

Operating range $0.8 \dots 1.2 \times U_s$,
 closing power of the solenoid coils **25 W** at 24 V

80	37	125	11	1	1	24	2	3RT2045-1KB40	2	3RT2045-3KB40
95	45	130	11	1	1	24	2	3RT2046-1KB40	2	3RT2046-3KB40

Other voltages [according to page 3/73](#) on request.

Accessories and spare parts, [see pages 3/75 to 3/124](#).

Switching Devices – Contactors and Contactor Assemblies – for Switching Motors

Power Contactors for Switching Motors

IE3/IE4 ready

SIRIUS 3RT contactors, 3-pole up to 250 kW

AC/DC operation

- Extended operating range of the solenoid coil 0.7 to 1.3 x U_s
- Reduced power consumption when closing and in the closed state





PU (UNIT, SET, M) = 1
 PS* = 1 unit
 PG = 41B



3RT202.-1N.30



3RT202.-2N.30

Rated data		Auxiliary contacts	Rated control supply voltage U_s	SD	Screw terminals 	SD	Spring-loaded terminals 
AC-2 and AC-3, t_{ij} : 60 °C	AC-1, t_{ij} : 40 °C	Ident. No.	50/60 Hz AC or DC		Article No.		Article No.
Operational current I_e up to 400 V	Operational current I_e up to 690 V	Version			Price per PU		Price per PU
400 V		 	V	d		d	
A	A	NO NC					
kW							

For screw fixing and snap-on mounting onto TH 35 standard mounting rail

Size S0

With integrated coil circuit (varistor integrated in electronics at the factory)

12	5.5	40	11	1	1	21 ... 28	▶	3RT2024-1NB30	5	3RT2024-2NB30
						95 ... 130	2	3RT2024-1NF30	5	3RT2024-2NF30
						200 ... 280	2	3RT2024-1NP30	2	3RT2024-2NP30
17	7.5	40	11	1	1	21 ... 28	2	3RT2025-1NB30	5	3RT2025-2NB30
						95 ... 130	2	3RT2025-1NF30	5	3RT2025-2NF30
						200 ... 280	2	3RT2025-1NP30	2	3RT2025-2NP30
25	11	40	11	1	1	21 ... 28	▶	3RT2026-1NB30	2	3RT2026-2NB30
						95 ... 130	2	3RT2026-1NF30	5	3RT2026-2NF30
						200 ... 280	5	3RT2026-1NP30	5	3RT2026-2NP30
32	15	50	11	1	1	21 ... 28	2	3RT2027-1NB30	2	3RT2027-2NB30
						95 ... 130	2	3RT2027-1NF30	5	3RT2027-2NF30
						200 ... 280	2	3RT2027-1NP30	5	3RT2027-2NP30
38	18.5	50	11	1	1	21 ... 28	5	3RT2028-1NB30	5	3RT2028-2NB30
						95 ... 130	5	3RT2028-1NF30	5	3RT2028-2NF30
						200 ... 280	2	3RT2028-1NP30	5	3RT2028-2NP30

Other voltages according to page 3/73 on request.

Accessories and spare parts, see pages 3/75 to 3/124.

Switching Devices – Contactors and Contactor Assemblies – for Switching Motors

Power Contactors for Switching Motors

SIRIUS 3RT contactors, 3-pole up to 250 kW IE3/IE4 ready
AC/DC operation

- Extended operating range of the solenoid coil 0.8 to 1.1 x U_s
- Reduced power consumption when closing and in the closed state

 PU (UNIT, SET, M) = 1
 PS* = 1 unit
 PG = 41B

3RT203.-1N.30



3RT203.-3N.30



3RT203.-1N.34



3RT203.-1NB34-3MA0



3RT203.-3NB34-3MA0

Rated data		Auxiliary contacts		Rated control supply voltage U_s	SD	Screw terminals		SD	Spring-loaded terminals	
AC-2 and AC-3, t_u : 60 °C	Operational current I_e up to 400 V	AC-1, t_u : 40 °C	Operational current I_e up to 690 V	50/60 Hz AC or DC		Article No.	Price per PU		Article No.	Price per PU
A	400 V	A		NO NC V	d					

For screw fixing and snap-on mounting onto TH 35 standard mounting rail
Size S2
With integrated coil circuit (varistor integrated in electronics at the factory)

40	18.5	60	11	1	1	20 ... 33	▶	3RT2035-1NB30	▶	3RT2035-3NB30
						83 ... 155	5	3RT2035-1NF30	5	3RT2035-3NF30
						175 ... 280	5	3RT2035-1NP30	5	3RT2035-3NP30
50	22	70	11	1	1	20 ... 33	▶	3RT2036-1NB30	▶	3RT2036-3NB30
						83 ... 155	5	3RT2036-1NF30	5	3RT2036-3NF30
						175 ... 280	5	3RT2036-1NP30	5	3RT2036-3NP30
65	30	80	11	1	1	20 ... 33	▶	3RT2037-1NB30	▶	3RT2037-3NB30
						83 ... 155	5	3RT2037-1NF30	5	3RT2037-3NF30
						175 ... 280	5	3RT2037-1NP30	5	3RT2037-3NP30
80	37	90	11	1	1	20 ... 33	▶	3RT2038-1NB30	▶	3RT2038-3NB30
						83 ... 155	5	3RT2038-1NF30	X	3RT2038-3NF30
						175 ... 280	5	3RT2038-1NP30	2	3RT2038-3NP30

With removable auxiliary switch and integrated coil circuit (varistor integrated in electronics at the factory)

40	18.5	60	22	2	2	20 ... 33	▶	3RT2035-1NB34	▶	---
						83 ... 155	5	3RT2035-1NF34		---
						175 ... 280	5	3RT2035-1NP34		---
50	22	70	22	2	2	20 ... 33	▶	3RT2036-1NB34	▶	---
						83 ... 155	5	3RT2036-1NF34		---
						175 ... 280	5	3RT2036-1NP34		---
65	30	80	22	2	2	20 ... 33	▶	3RT2037-1NB34	▶	---
						83 ... 155	5	3RT2037-1NF34		---
						175 ... 280	5	3RT2037-1NP34		---
80	37	90	22	2	2	20 ... 33	▶	3RT2038-1NB34	▶	---
						83 ... 155	5	3RT2038-1NF34		---
						175 ... 280	5	3RT2038-1NP34		---

With permanently mounted auxiliary switch and integrated coil circuit (varistor integrated in electronics at the factory)

40	18.5	60	22	2	2	20 ... 33	▶	3RT2035-1NB34-3MA0	▶	3RT2035-3NB34-3MA0
50	22	70	22	2	2	20 ... 33	▶	3RT2036-1NB34-3MA0	▶	3RT2036-3NB34-3MA0
65	30	80	22	2	2	20 ... 33	▶	3RT2037-1NB34-3MA0	▶	3RT2037-3NB34-3MA0
80	37	90	22	2	2	20 ... 33	▶	3RT2038-1NB34-3MA0	▶	3RT2038-3NB34-3MA0

With voltage tap-off and integrated coil circuit (varistor integrated in electronics at the factory)

40	18.5	60	11	1	1	20 ... 33	▶	3RT2035-1NB30-OCC0	▶	3RT2035-3NB30-OCC0
50	22	70	11	1	1	20 ... 33	▶	3RT2036-1NB30-OCC0	▶	3RT2036-3NB30-OCC0
65	30	80	11	1	1	20 ... 33	▶	3RT2037-1NB30-OCC0	▶	3RT2037-3NB30-OCC0
80	37	90	11	1	1	20 ... 33	▶	3RT2038-1NB30-OCC0	▶	3RT2038-3NB30-OCC0

Other voltages according to page 3/73 on request.

Accessories and spare parts, see pages 3/75 to 3/124.

Switching Devices – Contactors and Contactor Assemblies – for Switching Motors

Power Contactors for Switching Motors

IE3/IE4 ready

SIRIUS 3RT contactors, 3-pole up to 250 kW

AC/DC operation

- Extended operating range of the solenoid coil 0.8 to 1.1 x U_s
- Reduced power consumption when closing and in the closed state

PU (UNIT, SET, M) = 1
 PS* = 1 unit
 PG = 41B





3RT204.-1N.30

3RT204.-3N.30

3RT204.-1N.34

3RT204.-1NB34-3MA0

3RT204.-3NB34-3MA0

Rated data		Auxiliary contacts		Rated control supply voltage U_s	SD	Screw terminals 		SD	Spring-loaded terminals 	
AC-2 and AC-3, t_u : 60 °C	Operational current I_e up to 400 V	AC-1, t_u : 40 °C	Operational current I_e up to 690 V	50/60 Hz AC or DC		Article No.	Price per PU		Article No.	Price per PU
A	kW	A			d					

For screw fixing and snap-on mounting onto TH 35-15 and TH 75-15 standard mounting rails

Size S3

With integrated coil circuit (varistor integrated in electronics at the factory)

80	95	110	125	130	130	11	11	11	1	1	1	20 ... 33	83 ... 155	175 ... 280	2	5	5	3RT2045-1NB30	3RT2045-3NB30	3RT2045-3NF30	3RT2045-3NP30
37	45	55	37	45	55	11	11	11	1	1	1	20 ... 33	83 ... 155	175 ... 280	2	5	5	3RT2045-1NB30	3RT2045-3NB30	3RT2045-3NF30	3RT2045-3NP30
												83 ... 155	175 ... 280	5	5	5	3RT2046-1NB30	3RT2046-3NB30	3RT2046-3NF30	3RT2046-3NP30	
												175 ... 280		5	5	5	3RT2047-1NB30	3RT2047-3NB30	3RT2047-3NF30	3RT2047-3NP30	

With removable auxiliary switch and integrated coil circuit (varistor integrated in electronics at the factory)

80	95	110	125	130	130	22	22	22	2	2	2	20 ... 33	83 ... 155	175 ... 280	5	5	5	3RT2045-1NB34	3RT2045-1NF34	3RT2045-1NP34	---
37	45	55	37	45	55	22	22	22	2	2	2	20 ... 33	83 ... 155	175 ... 280	5	5	5	3RT2045-1NB34	3RT2045-1NF34	3RT2045-1NP34	---
												83 ... 155	175 ... 280	5	5	5	3RT2046-1NB34	3RT2046-1NF34	3RT2046-1NP34	---	
												175 ... 280		5	5	5	3RT2047-1NB34	3RT2047-1NF34	3RT2047-1NP34	---	

With permanently mounted auxiliary switch and integrated coil circuit (varistor integrated in electronics at the factory)

80	95	110	125	130	130	22	22	22	2	2	2	20 ... 33	20 ... 33	20 ... 33	5	5	5	3RT2045-1NB34-3MA0	3RT2046-1NB34-3MA0	3RT2047-1NB34-3MA0	3RT2045-3NB34-3MA0
37	45	55	37	45	55	22	22	22	2	2	2	20 ... 33	20 ... 33	20 ... 33	5	5	5	3RT2045-1NB34-3MA0	3RT2046-1NB34-3MA0	3RT2047-1NB34-3MA0	3RT2045-3NB34-3MA0

With voltage tap-off and integrated coil circuit (varistor integrated in electronics at the factory)

80	95	110	125	130	130	11	11	11	1	1	1	20 ... 33	20 ... 33	20 ... 33	5	5	5	3RT2045-1NB30-0CC0	3RT2046-1NB30-0CC0	3RT2047-1NB30-0CC0	3RT2045-3NB30-0CC0
37	45	55	37	45	55	11	11	11	1	1	1	20 ... 33	20 ... 33	20 ... 33	5	5	5	3RT2045-1NB30-0CC0	3RT2046-1NB30-0CC0	3RT2047-1NB30-0CC0	3RT2045-3NB30-0CC0

Other voltages [according to page 3/73](#) on request.

Accessories and spare parts, [see pages 3/75 to 3/124](#).

Switching Devices – Contactors and Contactor Assemblies – for Switching Motors

Power Contactors for Switching Motors

SIRIUS 3RT contactors, 3-pole up to 250 kW **IE3/IE4 ready**

AC/DC operation

- Standard operating mechanism 3RT10...-A
- For screw fixing
- Auxiliary and control conductors: Screw or spring-loaded terminals
- Main conductors: Busbar connections; a connection kit with screws, spring washers and nuts is enclosed.

PU (UNIT, SET, M) = 1
 PS* = 1 unit
 PG = 41B



3RT105-6A.36





3RT106-6A.36



3RT107-6A.36



3RT107-2A.36

Size	Rated data				AC-1, t_{ij} : 40 °C	Auxiliary contacts, lateral	Rated control supply voltage U_s	SD	Screw terminals 		Spring-loaded terminals 	
	AC-2 and AC-3, t_{ij} : 60 °C	Ratings of three-phase motors at 50 Hz and							Operational current I_{oe} up to	Version	Article No.	Price per PU
	Operational current I_{oe} up to	500 V	400 V	500 V	690 V	690 V	NO	NC	V	d	d	
A	kW	kW	kW	kW	A							

Standard operating mechanism with economy circuit for AC and DC operation (switchover from closing coil to holding coil)

With integrated coil circuit (varistor integrated at the factory)

Size	Rated current I_{oe} (A)	Rated power (kW)	Rated current I_{oe} (A)	Rated power (kW)	Rated current I_{oe} (A)	Rated power (kW)	Rated current I_{oe} (A)	Rated power (kW)	SD	Article No.	Price per PU	Article No.	Price per PU
S6	115	55	75	110	160	2	2	110 ... 127 220 ... 240	▶	3RT1054-6AF36 3RT1054-6AP36	5 5	3RT1054-2AF36 3RT1054-2AP36	
	150	75	90	132	185	2	2	110 ... 127 220 ... 240	▶	3RT1055-6AF36 3RT1055-6AP36	5 5	3RT1055-2AF36 3RT1055-2AP36	
	185	90 ¹⁾	110	160	215	2	2	110 ... 127 220 ... 240	▶	3RT1056-6AF36 3RT1056-6AP36	5 5	3RT1056-2AF36 3RT1056-2AP36	
S10	225	110	160	200	275	2	2	110 ... 127 220 ... 240	▶	3RT1064-6AF36 3RT1064-6AP36	5 5	3RT1064-2AF36 3RT1064-2AP36	
	265	132	160	250	330	2	2	110 ... 127 220 ... 240	▶	3RT1065-6AF36 3RT1065-6AP36	5 5	3RT1065-2AF36 3RT1065-2AP36	
	300	160 ¹⁾	200	250	330	2	2	110 ... 127 220 ... 240	▶	3RT1066-6AF36 3RT1066-6AP36	5 5	3RT1066-2AF36 3RT1066-2AP36	
S12	400	200	250	400	430	2	2	110 ... 127 220 ... 240	▶	3RT1075-6AF36 3RT1075-6AP36	5 5	3RT1075-2AF36 3RT1075-2AP36	
	500	250 ¹⁾	355	400	610	2	2	110 ... 127 220 ... 240	▶	3RT1076-6AF36 3RT1076-6AP36	5 5	3RT1076-2AF36 3RT1076-2AP36	

¹⁾ When using 3RT10.6-**A**... contactors with IE3/IE4 motors from 8.5 times the starting current, use the versions with solid-state operating mechanism 3RT10.6-**N**..., see page 3/72.
 For more information about dimensioning and configuring, see page 3/7.

Other voltages according to page 3/74 on request.

Accessories and spare parts, see pages 3/75 to 3/124.

Switching Devices – Contactors and Contactor Assemblies – for Switching Motors

Power Contactors for Switching Motors

IE3/IE4 ready

SIRIUS 3RT contactors, 3-pole up to 250 kW

AC/DC operation

- Solid-state operating mechanism with fail-safe control input for safety-related applications to SIL CL 3
- 24 V DC control signal input, e.g. for control via the fail-safe output module of a controller (F-PLC) or safety relay
- Attainable Safety Integrity Level (SIL):
 - With one contactor: SIL CL 2 acc. to IEC 62061 or PL c acc. to ISO 13849-1
 - With two contactors in series: SIL CL 3 acc. to IEC 62061 or PL e acc. to ISO 13849-1
- Version with removable lateral auxiliary switches or permanently mounted auxiliary switches
- For screw fixing
- Auxiliary and control conductors: Screw or spring-loaded terminals
- Main conductors: Busbar connections; a connection kit with screws, spring washers and nuts is enclosed.

For more information on safety systems, see page 11/1 onwards.



Size	Rated data according to IEC 60947-4-1 AC-3, t_i : 60 °C Operational current I_e up to	Auxiliary contacts, lateral Version	Rated control supply voltage U_s 50/60 Hz AC or DC	SD	Screw terminals 	PU (UNIT, SET, M)	PS*	PG
3RT105.-6S.36	500 V A	NO NC	V	d	Article No.	Price per PU		

Solid-state operating mechanism

With two removable laterally mounted auxiliary switches

With integrated coil circuit (varistor integrated in electronics at the factory)

S6	115	55	2	2	96 ... 127 200 ... 277	5	3RT1054-6SF36 3RT1054-6SP36	1	1 unit	41B
	150	75	2	2	96 ... 127 200 ... 277	5	3RT1055-6SF36 3RT1055-6SP36	1	1 unit	41B
	185	90	2	2	96 ... 127 200 ... 277	5	3RT1056-6SF36 3RT1056-6SP36	1	1 unit	41B
S10	225	110	2	2	96 ... 127 200 ... 277	5	3RT1064-6SF36 3RT1064-6SP36	1	1 unit	41B
	265	132	2	2	96 ... 127 200 ... 277	5	3RT1065-6SF36 3RT1065-6SP36	1	1 unit	41B
	300	160	2	2	96 ... 127 200 ... 277	5	3RT1066-6SF36 3RT1066-6SP36	1	1 unit	41B
S12	400	200	2	2	96 ... 127 200 ... 277	5	3RT1075-6SF36 3RT1075-6SP36	1	1 unit	41B
	500	250	2	2	96 ... 127 200 ... 277	5	3RT1076-6SF36 3RT1076-6SP36	1	1 unit	41B

With two permanently laterally mounted auxiliary switches

With integrated coil circuit (varistor integrated in electronics at the factory)

S6	115	55	2	2	96 ... 127 200 ... 277	5	3RT1054-6SF36-3PA0 3RT1054-6SP36-3PA0	1	1 unit	41B
	150	75	2	2	96 ... 127 200 ... 277	5	3RT1055-6SF36-3PA0 3RT1055-6SP36-3PA0	1	1 unit	41B
	185	90	2	2	96 ... 127 200 ... 277	5	3RT1056-6SF36-3PA0 3RT1056-6SP36-3PA0	1	1 unit	41B
S10	225	110	2	2	96 ... 127 200 ... 277	5	3RT1064-6SF36-3PA0 3RT1064-6SP36-3PA0	1	1 unit	41B
	265	132	2	2	96 ... 127 200 ... 277	5	3RT1065-6SF36-3PA0 3RT1065-6SP36-3PA0	1	1 unit	41B
	300	160	2	2	96 ... 127 200 ... 277	5	3RT1066-6SF36-3PA0 3RT1066-6SP36-3PA0	1	1 unit	41B
S12	400	200	2	2	96 ... 127 200 ... 277	5	3RT1075-6SF36-3PA0 3RT1075-6SP36-3PA0	1	1 unit	41B
	500	250	2	2	96 ... 127 200 ... 277	5	3RT1076-6SF36-3PA0 3RT1076-6SP36-3PA0	1	1 unit	41B

Accessories and spare parts, see pages 3/75 to 3/124.

Switching Devices – Contactors and Contactor Assemblies – for Switching Motors

Power Contactors for Switching Motors



SIRIUS 3RT contactors, 3-pole up to 250 kW **IE3/IE4 ready**

AC/DC operation

- Solid-state operating mechanism
 - 3RT10...-N with 24 V DC control signal input
 - 3RT10...-P with 24 V DC control signal input and with remaining lifetime indicator (RLT)
- For screw fixing
- Auxiliary and control conductors: Screw or spring-loaded terminals
- Main conductors: Busbar connections; a connection kit with screws, spring washers and nuts is enclosed.

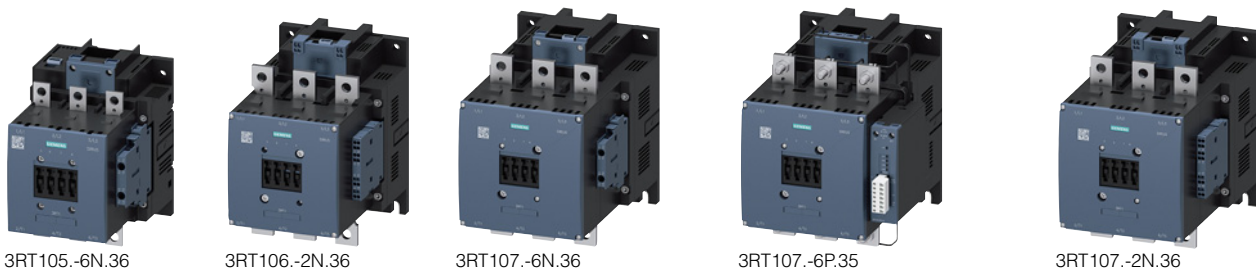
PU (UNIT, SET, M) = 1
 PS* = 1 unit
 PG = 41B



Size	Rated data	Auxiliary contacts, lateral	Rated control supply voltage U_s	SD	Screw terminals 	SD	Spring-loaded terminals 
	AC-2 and AC-3, t_{ij} : 60 °C	AC-1, t_{ij} : 40 °C	50/60 Hz AC or DC		Article No.		Article No.
	Operational current I_e up to	Operational current I_e up to	Version		Price per PU		Price per PU
	500 V	690 V					
	400 V	500 V					
	500 V	690 V					
	A	A					
	kW	kW					

Solid-state operating mechanism

With 24 V DC control signal input
 e.g. for control by PLC

With integrated coil circuit (varistor integrated in electronics at the factory)

Size	115	55	75	110	160	2	2	96 ... 127 200 ... 277	5	3RT1054-6NF36 3RT1054-6NP36	5	3RT1054-2NF36 3RT1054-2NP36
S6	150	75	90	132	185	2	2	96 ... 127 200 ... 277	5	3RT1055-6NF36 3RT1055-6NP36	5	3RT1055-2NF36 3RT1055-2NP36
	185	90	110	160	215	2	2	96 ... 127 200 ... 277	5	3RT1056-6NF36 3RT1056-6NP36	5	3RT1056-2NF36 3RT1056-2NP36
	S10	225	110	160	200	275	2	2	96 ... 127 200 ... 277	2	3RT1064-6NF36 3RT1064-6NP36	5
S10	265	132	160	250	330	2	2	96 ... 127 200 ... 277	2	3RT1065-6NF36 3RT1065-6NP36	5	3RT1065-2NF36 3RT1065-2NP36
	300	160	200	250	330	2	2	96 ... 127 200 ... 277	5	3RT1066-6NF36 3RT1066-6NP36	5	3RT1066-2NF36 3RT1066-2NP36
S12	400	200	250	400	430	2	2	96 ... 127 200 ... 277	2	3RT1075-6NF36 3RT1075-6NP36	5	3RT1075-2NF36 3RT1075-2NP36
	500	250	355	400	610	2	2	96 ... 127 200 ... 277	2	3RT1076-6NF36 3RT1076-6NP36	5	3RT1076-2NF36 3RT1076-2NP36

For 24 V DC control signal input · with remaining lifetime indicator (RLT)
 e.g. for control by PLC

With integrated coil circuit (varistor integrated in electronics at the factory)

Size	115	55	75	110	160	1	1	96 ... 127 200 ... 277	5	3RT1054-6PF35 3RT1054-6PP35	--
S6	150	75	90	132	185	1	1	96 ... 127 200 ... 277	5	3RT1055-6PF35 3RT1055-6PP35	--
	185	90	110	160	215	1	1	96 ... 127 200 ... 277	5	3RT1056-6PF35 3RT1056-6PP35	--
	S10	225	110	160	200	275	1	1	96 ... 127 200 ... 277	5	3RT1064-6PF35 3RT1064-6PP35
S10	265	132	160	250	330	1	1	96 ... 127 200 ... 277	5	3RT1065-6PF35 3RT1065-6PP35	--
	300	160	200	250	330	1	1	96 ... 127 200 ... 277	5	3RT1066-6PF35 3RT1066-6PP35	--
S12	400	200	250	400	430	1	1	96 ... 127 200 ... 277	5	3RT1075-6PF35 3RT1075-6PP35	--
	500	250	355	400	610	1	1	96 ... 127 200 ... 277	5	3RT1076-6PF35 3RT1076-6PP35	--

Other voltages according to page 3/74 on request.

Accessories and spare parts, see pages 3/75 to 3/124.

Switching Devices – Contactors and Contactor Assemblies – for Switching Motors

Power Contactors for Switching Motors

SIRIUS 3RT contactors, 3-pole up to 250 kW

Options

Rated control supply voltages for 3RT20 contactors, possible on request (change of the 10th and 11th digits of the Article No.)

Delivery time on request

Rated control supply voltage U_s	Contactor type Size	3RT201, 3RH2 S00	3RT202 S0	3RT203 S2	3RT204 S3
Sizes S00 to S3					
AC operation¹⁾					
Solenoid coils for 50 Hz (exception: size S00: 50 and 60 Hz ²⁾)					
24 V AC		B0	B0	B0	B0
42 V AC		D0	D0	D0	D0
48 V AC		H0	H0	H0	H0
110 V AC		F0	F0	F0	F0
230 V AC		P0	P0	P0	P0
240 V AC		U0	U0	U0	U0
400 V AC		V0	V0	V0	V0
Solenoid coils for 50 and 60 Hz²⁾					
24 V AC		B0	C2	C2	C2
42 V AC		D0	D2	D2	D2
48 V AC		H0	H2	H2	H2
110 V AC		F0	G2	G2	G2
220 V AC		N2	N2	N2	N2
230 V AC		P0	L2	L2	L2
Solenoid coils (for USA and Canada³⁾)					
50 Hz					
110 V AC	120 V AC	K6	K6	K6	K6
220 V AC	240 V AC	P6	P6	P6	P6
Solenoid coils (for Japan)					
50/60 Hz⁴⁾					
100 V AC	110 V AC	G6	G6	G6	G6
200 V AC	220 V AC	N6	N6	N6	N6
400 V AC	440 V AC	R6	R6	R6	R6
DC operation¹⁾					
12 V DC		A4	A4	--	--
24 V DC		B4	B4	--	--
42 V DC		D4	D4	--	--
48 V DC		W4	W4	--	--
60 V DC		E4	E4	--	--
110 V DC		F4	F4	--	--
125 V DC		G4	G4	--	--
220 V DC		M4	M4	--	--
230 V DC		P4	P4	--	--

Examples

AC operation	3RT2023-1A P00	Contactors with screw terminals; with solenoid coil for 50 Hz for rated control supply voltage 230 V AC.
	3RT2023-1A G20	Contactors with screw terminals; with solenoid coil for 50/60 Hz for rated control supply voltage 110 V AC.
DC operation	3RT2025-2B B40	Contactors with spring-loaded terminals; for rated control supply voltage 24 V DC.
	3RT2025-2B G40	Contactors with spring-loaded terminals; for rated control supply voltage 125 V DC.

¹⁾ For deviating coil voltages and operating ranges of sizes S00 and S0, a SITOP 24 V DC power supply with wide-range input can be used for the coil control, see page 15/1 and Catalog KT 10.1.

²⁾ Coil operating range
- At 50 Hz: 0.8 to $1.1 \times U_s$
- At 60 Hz: 0.85 to $1.1 \times U_s$.

³⁾ Coil operating range
- Size S00:
At 50 Hz: 0.85 to $1.1 \times U_s$
At 60 Hz: 0.8 to $1.1 \times U_s$
- Sizes S0 to S3: At 50 Hz and 60 Hz: 0.8 to $1.1 \times U_s$.

⁴⁾ Coil operating range
- Size S00:
At 50/60 Hz: 0.85 to $1.1 \times U_s$
- Size S0:
At 50 Hz: 0.8 to $1.1 \times U_s$
At 60 Hz: 0.85 to $1.1 \times U_s$.

⁵⁾ Coil operating range at 60 Hz: 0.8 to $1.1 \times U_s$.

Rated control supply voltage $U_{s \min} \dots U_{s \max}$ ¹⁾	Contactor type Size	3RT202.-N S0	Rated control supply voltage $U_{s \min} \dots U_{s \max}$ ¹⁾	Contactor type Size	3RT203.-N S2	3RT204.-N S3
Sizes S00 to S3						
AC/DC operation (50/60 Hz AC or DC)						
21 ... 28 V AC/DC		B3	20 ... 33 V AC/DC		B3	B3
95 ... 130 V AC/DC		F3	48 ... 80 V AC/DC		E3	E3
200 ... 280 V AC/DC ²⁾		P3	83 ... 155 V AC/DC		F3	F3
			175 ... 280 V AC/DC		P3	P3

¹⁾ Coil operating range
- Size S0: $0.7 \times U_{s \min}$ to $1.3 \times U_{s \max}$
- Sizes S2 and S3: $0.8 \times U_{s \min}$ to $1.1 \times U_{s \max}$

²⁾ The following applies to S0 and $U_{s \max} = 280$ V: Upper limit = $1.1 \times U_{s \max}$

Switching Devices – Contactors and Contactor Assemblies – for Switching Motors

Power Contactors for Switching Motors

SIRIUS 3RT contactors, 3-pole up to 250 kW

Rated control supply voltages for 3RT10 contactors, possible on request (change of the 10th and 11th digits of the Article No.)

Delivery time on request

Rated control supply voltage	Contactor type 3RT105.-A, 3RT106.-A, 3RT107.-A	Rated control supply voltage	Contactor type 3RT105.-N, 3RT106.-N, 3RT107.-N	3RT105.-P, 3RT105.-S, 3RT106.-P, 3RT106.-S, 3RT107.-P, 3RT107.-S
$U_{s \min} \dots U_{s \max}$	Sizes S6 to S12	$U_{s \min} \dots U_{s \max}$	Sizes S6 to S12	

Sizes S6 to S12

AC/DC operation (50/60 Hz AC or DC) and operating range $0.8 \times U_{s \min} \dots 1.1 \times U_{s \max}$

Standard operating mechanism

23 ... 26 V AC/DC	B3
42 ... 48 V AC/DC	D3
110 ... 127 V AC/DC	F3
200 ... 220 V AC/DC	M3
220 ... 240 V AC/DC	P3
240 ... 277 V AC/DC	U3
380 ... 420 V AC/DC	V3
440 ... 480 V AC/DC	R3
500 ... 550 V AC/DC	S3
575 ... 600 V AC/DC	T3

Solid-state operating mechanism

21 ... 27.3 V AC/DC	B3	--
96 ... 127 V AC/DC	F3	F3
200 ... 277 V AC/DC	P3	P3

Switching Devices – Contactors and Contactor Assemblies – for Switching Motors

Power Contactors for Switching Motors

Accessories for SIRIUS 3RT contactors and SIRIUS 3RH2 contactor relays > General data

Overview

Extensive accessories and spare parts are available for SIRIUS 3RT power contactors and SIRIUS 3RH2 contactor relays.

These components are easily fitted to the contactors without the use of any tools according to requirements.

Overview graphics with mountable accessories:

- 3RT2 contactors, see pages 3/8 to 3/11
- 3RT10, 3RT12 and 3RT14 contactors, see pages 3/12 to 3/16
- 3RH2 contactor relays, see page 5/4

More information

TIA Selection Tool Cloud (TST Cloud), see
<https://www.siemens.com/tstcloud/?node=Contactor>

Version	For contactors 3RT2, sizes S00 to S3; 3RH2, size S00	3RT10, 3RT12, 3RT14; sizes S6 to S12	Selection and ordering data Page
Accessories for 3RT contactors and 3RH2 contactor relays			
Auxiliary switches			
Instantaneous	3RH29.1	3RH19.1	3/87 ... 3/99
Delayed			
• Pneumatic time-delay auxiliary switches	3RT2926-2P.1	--	3/100
• Solid-state time-delay auxiliary switches	3RA2813, 3RA2814, 3RA2815	3RT1926-2E/-2F/-2G	3/100, 3/101
Surge suppressors			
• Without LED	3RT29.6-1B/-1C/-1D/-1E	3RT1956-1C	3/102, 3/103
• With LED	3RT29.6-1J/-1L/-1M	--	3/103
Modules for contactor control			
Coupling links for control by PLC	3RH29.4-.GP11	--	3/104
3RA28 function modules			
• For direct on-line starting: ON delay or OFF-delay	3RA2811, 3RA2812, 3RA2831, 3RA2832	--	3/105
• For star-delta (weye-delta) starting	3RA2816	--	3/105
3RA27 function modules for IO-Link or AS-Interface			
• For direct-on-line, reversing or star-delta (weye-delta) starting	3RA271.-.A/B/C	--	3/106, 3/107
Mechanical latching blocks	3RT2926-3A.31	--	3/108
OFF-delay devices for contactors with AC/DC and DC operation	3RT2916-2B.01	--	3/108
Link modules			
Link modules from motor starter protector to contactor	3RA.9.1	--	7/56
Safety main current connectors for two contactors	3RA29.6-1A	--	3/109
Assembly kits			
• For reversing contactor assemblies	3RA29.3-2AA.	3RA19.3-2A	3/109
• For contactor assemblies for star-delta (weye-delta) starting	3RA29.-.2BB., 3RA29.3-2C	3RA1953-3G, 3RA19.3-2./-3.	3/110, 3/111
Single wiring modules	3RA.9.3-3.A.	3RA19.3-3.	3/112
Star jumpers (links for paralleling), 3-pole	3RT.9.6-4BA3.	3RT19.6-4BA31	3/112
Mechanical interlock kits for two contactors	3RA29.2-2H	--	3/113
Mechanical interlocks for contactor assemblies	3RA2934-2B	3RA1954-2.	3/113
Mechanical connectors for contactor assemblies	3RA29.2-2.	3RA1932-2D	3/113
Terminal modules/adapters			
Links for paralleling for main circuits	3RT.9.6-4BB.1	--	3/114
Single-phase infeed terminals	3RA2943-3L	--	3/115
Three-phase infeed terminals	3RA2913-3K, 3RV29.5-5A.	--	3/115
• With increased clearances and creepage distances	3RV2935-5E	--	3/115
Three-phase busbars	3RV1915-1AB	--	3/115
Terminal blocks for connecting auxiliary conductors to main terminals			
• Box terminal blocks	3RT2946-4G	3RT19.-.4G	3/115
• Box terminal for auxiliary conductor connection, 1-pole	--	3TX7500-0A	3/115
• Auxiliary terminals, 3-pole	3RT2946-4F	--	3/115
Solder pin adapters for mounting contactors onto printed circuit boards	3RT1916-4KA.	--	3/116
Coil connection modules for connections from top or from bottom	3RT2926-4R.1.	--	3/116
Connection module (adapter and plug) for contactors with screw terminals			
• Adapters	3RT19.6-4RD01	--	3/116
• Motor feeder connector	3RT1900-4RE01	--	3/116

Switching Devices – Contactors and Contactor Assemblies – for Switching Motors

Power Contactors for Switching Motors

Accessories for SIRIUS 3RT contactors and SIRIUS 3RH2 contactor relays > General data

Version	For contactors		Selection and ordering data
	3RT2, sizes S00 to S3; 3RH2, size S00	3RT10, 3RT12, 3RT14; sizes S6 to S12	
Page			
Accessories for 3RT contactors and 3RH2 contactor relays (continued)			
Covers			
Terminal covers	3RT1946-4EA1, 3RT29.6-4EA.	3RT1956-4EA., 3RT1966-4EA., 3TX65.6-3B	3/117
Sealable covers	3RT2916-4MA10	3RT1926-4MA10	3/117
Miscellaneous accessories			
Base plates			
• For reversing contactor assemblies	--	3RT19.2-2A	3/118
• For contactor assemblies for star-delta (wye-delta) starting	3RA29.2-2F	3RA19.2-2.	3/118
Adapters for screw fixing	3RT1926-4P	--	3/118
Connection kit for one complete contactor	--	3RT19...4PA00	3/118
EMC suppression modules	3RT2916-1P . .	--	3/118
Additional load modules	3RT2916-1GA00	--	3/119
LED modules for displaying contactor operation	3RT2926-1QT00	3RT1926-1QT00	3/119
Control kit	3RT29.6-4MC00	--	3/119
Insulation stop for securely holding back the conductor insulation for conductors up to 1 mm²	3RT2916-4JA02	3RT1916-4JA02	3/120
Tools for opening spring-loaded terminals	3RA2908-1A	3RA2908-1A	3/120
Blank labels	3RT2900-1SB.0	3RT2900-1SB.0	3/120
Spare parts for 3RT2 contactors			
Solenoid coils	3RT29...5...1	--	3/121, 3/122
Withdrawable coils	--	3RT19...5....	3/123
Contacts with fixing parts	3RT29...-6.	3RT19...-6.	3/124
Arc chutes	--	3RT19...-7.	3/124

Switching Devices – Contactors and Contactor Assemblies – for Switching Motors

Power Contactors for Switching Motors

Accessories for SIRIUS 3RT contactors and SIRIUS 3RH2 contactor relays > General data

Auxiliary switches

The auxiliary switches can be designed as positively driven contacts in 3RH contactor relays or also as mirror contacts in the case of 3RT power contactors.

For more information on positively driven operation and mirror contacts, see [Manuals](#) → "More information", page 3/82, and in the [selection and ordering data](#), page 3/87 onwards.

Solid-state time-delay auxiliary switches for mounting onto 3RT2 contactors and 3RH2 contactor relays

See pages 3/82 and 3/100

The 3RA28 solid-state time-delay auxiliary switches which can be mounted onto the contactor are designed for applications in the range from 24 to 240 V AC/DC (wide voltage range). Both the electrical and mechanical connection are made by simple snapping on and locking.

The time-delay auxiliary switch is supplied with power directly by two plug-in contacts through the coil terminals of the contactor, in parallel with A./A2.

A protection circuit (varistor) is integrated in each module.

A sealable cover is available to protect against careless adjustment of the set times.

Note:

Mounting more auxiliary switches onto the contactor is not permitted.

Surge suppressors

- Without LED (also for spring-loaded terminals)
Sizes S00 to S3, see [page 3/102](#)
- With LED (also for spring-loaded terminals)
Sizes S00 to S3, see [page 3/103](#)

All 3RT2 contactors and 3RH2 contactor relays can be retrofitted with RC elements or varistors for damping opening surges in the coil. Diodes or diode assemblies (comprising noise suppression diodes and Zener diodes for short break times) can be used.

The surge suppressors are plugged onto the front of size S00 contactors. Space is provided for them next to a snap-on auxiliary switch.

Varistors, RC elements or diode assemblies can be plugged onto the front of size S0 to S3 contactors.

Coupling contactors are supplied either without overvoltage damping or with a suppressor diode, varistor or diode connected as standard, according to the version.

Note:

The OFF-delay times of the NO contacts and the ON-delay times of the NC contacts increase if the contactor coils are attenuated against voltage peaks (suppression diode 6x to 10x; diode assemblies 2x to 6x; varistor +2 to 5 ms).

Coupling links for control by PLC

See pages 3/84 and 3/104

- Operation with 24 V DC
- Operating range 17 to 30 V
- Low power consumption of 0.5 W
- An LED indicates the switching state.

The 3RH2924-1GP11 coupling link has an integrated surge suppressor (varistor) for the contactor coil being switched and is mounted onto the size S0 contactor coil via a coil connection module.

Switching Devices – Contactors and Contactor Assemblies – for Switching Motors

Power Contactors for Switching Motors

Accessories for SIRIUS 3RT contactors and SIRIUS 3RH2 contactor relays > General data

3RA28 function modules for mounting onto 3RT2 contactors and 3RH2 contactor relays

See pages 3/85 and 3/105

Simply by being plugged in place, the SIRIUS function modules enable different functionalities required for the assembly of starters to be realized in the feeder. The function modules and wiring kits thus help to reduce the wiring work within the feeder practically to zero.

SIRIUS function modules for direct-on-line starting

The electronic timing relays which can be mounted onto the contactor are available in these versions:

- Sizes S00 and S0 for applications in the range from 24 to 240 V AC/DC (wide voltage range)
- Sizes S2 and S3 for applications in either the range from 24 to 90 V AC/DC or 90 to 240 V AC/DC

Both the electrical and mechanical connection are made by simple snapping on and locking.

A protection circuit (varistor) is integrated in each module.

The electronic timing relay with semiconductor output uses two contact legs to actuate the contactor underneath by means of a semiconductor after the set time t has elapsed.

The switching state feedback is performed by a mechanical switching state indicator (plunger). In addition, the auxiliary switches in the contactors are freely accessible and can be used for feedbacks to the control system or for signal lamps.

A sealable cover is available to protect against careless adjustment of the set times.

The snap-on *function modules for direct-on-line starting* are used above all for realizing timing functions independently of the control system.

With the OFF-delay variant of the timing relay it is possible for example for the fan motor for cooling a main drive to be switched off with a delay so that sufficient cooling after operation is guaranteed; the programmer of the control system does not need to worry about such technical details of the plant.

The ON-delay timing relays enable for example the time-delayed starting of several drives so that the summation starting current does not rise too high, which could result in voltage failure.

The use of snap-on function modules for direct-on-line starting results in the following advantages:

- Reduction of control current wiring
- Prevention of wiring errors
- Reduction of testing costs
- Implementation of timing functions independently of the control system
- Less space required in the control cabinet compared to a separate timing relay
- No additive protection circuit required (varistor integrated)

Assembly of reversing starters

We offer ready-made wiring kits for the assembly of reversing starters. Use of these wiring kits offers further advantages, see page 3/151.

SIRIUS function modules for star-delta (weye-delta) starting

Both interlocking and timing functions are required for the assembly of star-delta (weye-delta) starters. With the function modules for star-delta (weye-delta) starting and the matching link modules for the main circuit, these starters can be assembled easily and with absolutely no errors.

The entire sequence in the control circuit is integrated in the snap-on modules. This covers:

- An adjustable star time t from 0.5 to 60 s
- A non-adjustable dead interval of 50 ms
- Electrical contacting of the contactors by means of coil pick-off (contact legs)
- Feedback of the switching state at the contactor using a mechanical switch position indicator (plunger)
- Electrical interlocking between the contactors

These modules do not require their own terminals and can therefore be used for contactors with both screw and spring-loaded terminals in all the sizes S00 to S3. To start the star-delta (weye-delta) starter, only the first of the three contactors (line contactor) is actuated, like in the case of a direct-on-line starter. All other functions then take place inside the individual modules.

This also offers advantages if the timing function was previously implemented in a controller, as it again results in a significant reduction in the number of PLC outputs, the programming work and the wiring outlay.

The kits for the main circuit include the mechanical interlock, the star jumper, the wiring modules at the top and at the bottom, and the required connectors or connecting clips.

A protection circuit (varistor) is integrated in the basic module.

The *function modules for star-delta (weye-delta) starting* are mostly used where current-limiting measures for starting a drive are required and a high level of availability is essential at the same time. This technology has been used with success for several decades and has the additional advantage of requiring relatively little know-how. Through the use of function modules, the assembly work with simple standard components is even easier and absolutely error-free.

The use of *function modules for star-delta (weye-delta) starting* results in the following advantages:

- Operation solely through the line contactor A1/A2 – no further control current wiring needed
- Prevention of wiring errors
- Reduction of testing costs
- Integrated electrical interlocking saves costs and prevents errors
- Less space needed in the control cabinet compared to using a separate timing relay
- Adjustable starting in star mode from 0.5 to 60 s
- Independent of the contactor's control supply voltage (24 to 240 V AC/DC)
- Varistor integrated – no additive protection circuit required
- Mechanically coded assembly enables easy configuration and reliable wiring
- Fewer versions – one module kit for screw and spring-loaded connection and for all the contactor sizes S00 to S3
- Mechanical interlocking (with wiring kit for the main circuit)

Switching Devices – Contactors and Contactor Assemblies – for Switching Motors

Power Contactors for Switching Motors

Accessories for SIRIUS 3RT contactors and SIRIUS 3RH2 contactor relays > General data

SIRIUS 3RA27 function modules for IO-Link or AS-Interface for mounting onto 3RT2 contactors

See pages 3/86 and 3/106

The SIRIUS 3RA27 function modules enable the assembly of starters and contactor assemblies for direct-on-line, reversing and star-delta (wye-delta) starting without any additional, complicated wiring of the individual components. They include the key control functions required for the particular feeder, e.g. timing and interlocking, and can be connected to the control system via either IO-Link or AS-Interface.

The electrical and mechanical connection to the contactor is established by snapping on and locking the respective modules. An additive protection circuit for the individual contactors can be dispensed with completely because a varistor is integrated in the modules. Feedback from the contactor contacts is performed with Hall sensors which provide reliable feedback concerning the switching state even under extremely dusty conditions.

The starters are connected to the higher-level control system through IO-Link, with the possibility of connecting up to four starters as a group to one port of the IO-Link master, or optionally via AS-Interface, specification V2.1 or higher, in A/B technology. As a result, up to 62 starters can be connected to one master and the address is entered in the normal manner with an addressing unit.

Through this type of connection to the control system, a maximum of wiring is saved. In the case of AS-Interface, the wiring amounts to the control supply voltage and the two individual wires for AS-Interface.

The following essential signals are thus transmitted:

- Availability of the feeder in response to an indirect inquiry from the motor starter protector/circuit breaker
- Starter control
- Feedback concerning the switching state of the starter

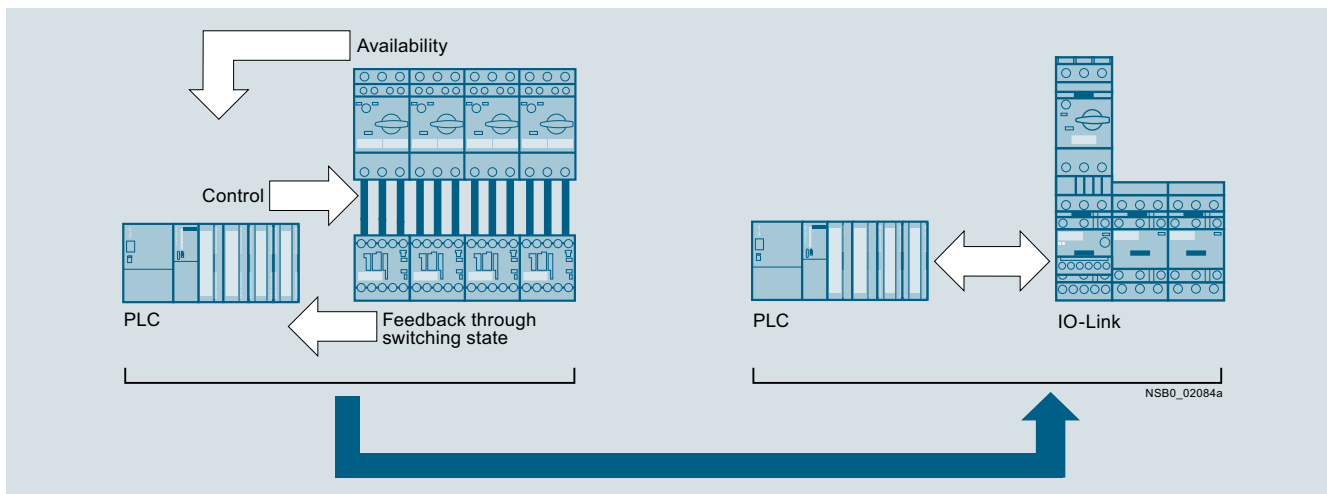

Signal transmission through IO-Link

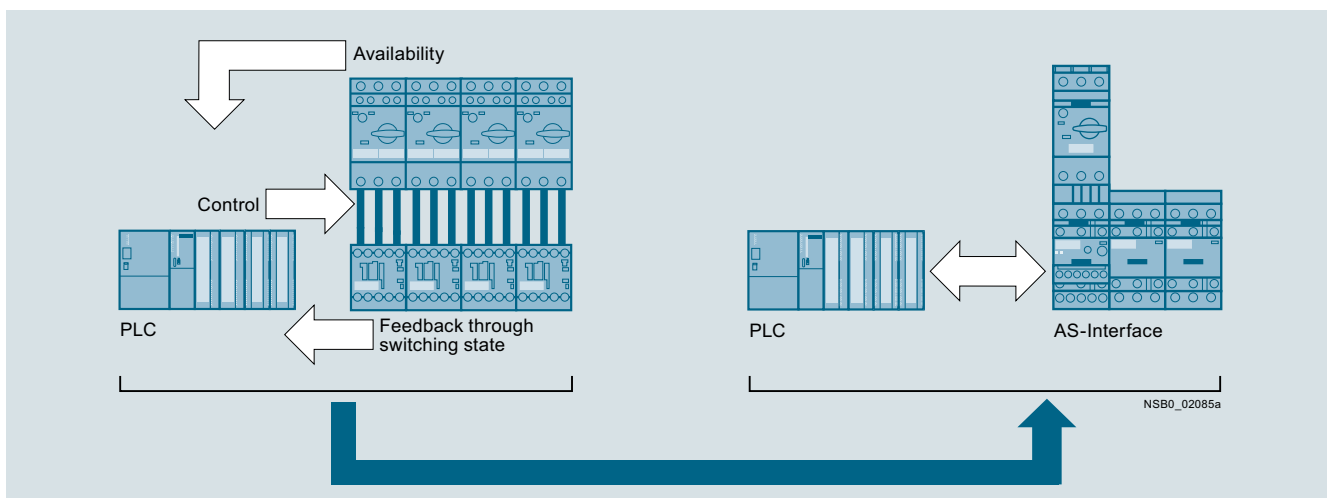

Signal transmission through AS-Interface

Switching Devices – Contactors and Contactor Assemblies – for Switching Motors

Power Contactors for Switching Motors

Accessories for SIRIUS 3RT contactors and SIRIUS 3RH2 contactor relays > General data

The inquiry from the motor starter protector/circuit breaker does not take place through additive wiring between the auxiliary switch and the module but by means of a voltage inquiry at the contactor input.

This requires special versions of the 3RT20...-.....0CC0 contactors with voltage tap-off (see pages 3/60, 3/64, 3/68 and 3/69).

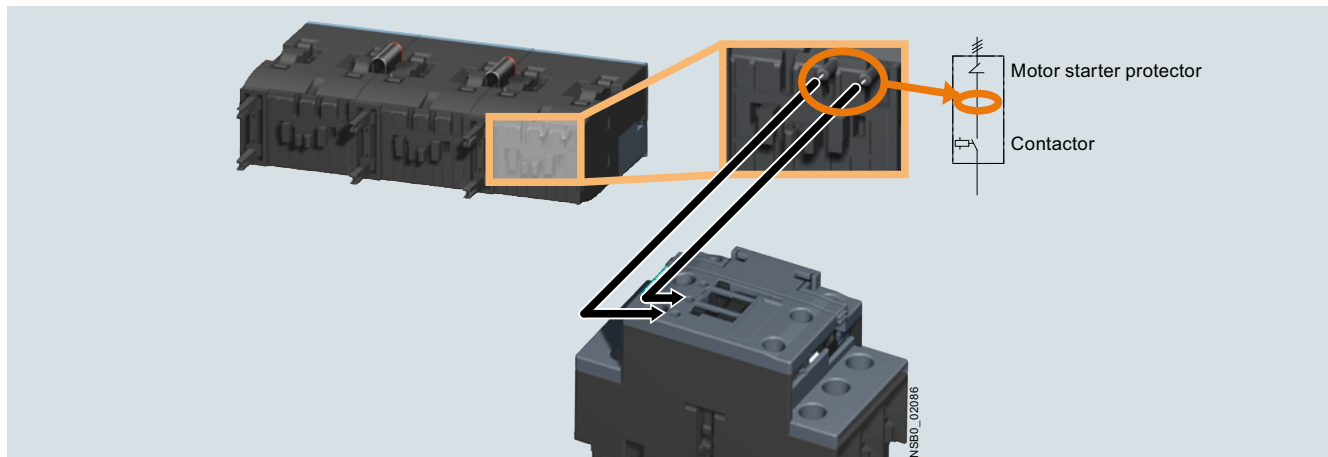

Availability signal through voltage tap-off

The following benefits result from the use of SIRIUS 3RA27 function modules:

- Reduction of control current wiring. In the case of IO-Link to no more than three cables for four feeders.
- Elimination of testing costs and wiring errors
- Reduction of configuration work
- Parameter server functionality
- Integration in TIA means unambiguous IO-Link diagnostics if a fault occurs

- Dispensing with IO modules saves space in the control cabinet
- All essential timing and interlocking functions for reversing duty and star-delta (wye-delta) starting are integrated
- No additive protection circuit required

For more information on IO-Link and AS-Interface, see "Industrial Communication", page 2/1 onwards.

SIRIUS 3RA2711 function modules for IO-Link for mounting onto 3RT2 contactors

By grouping up to four starters, it is possible to connect up to 16 starters to one master of the ET 200SP or S7-1200. In this case all the signals of the individual controls are made available directly in the process image of the input through only three individual wires per starter group. If the same potential is present

at the ET 200SP or S7-1200 master and at the switching devices, the wiring can be further reduced by connecting the supply voltage of the contactor coils to the communication wires via jumpers.

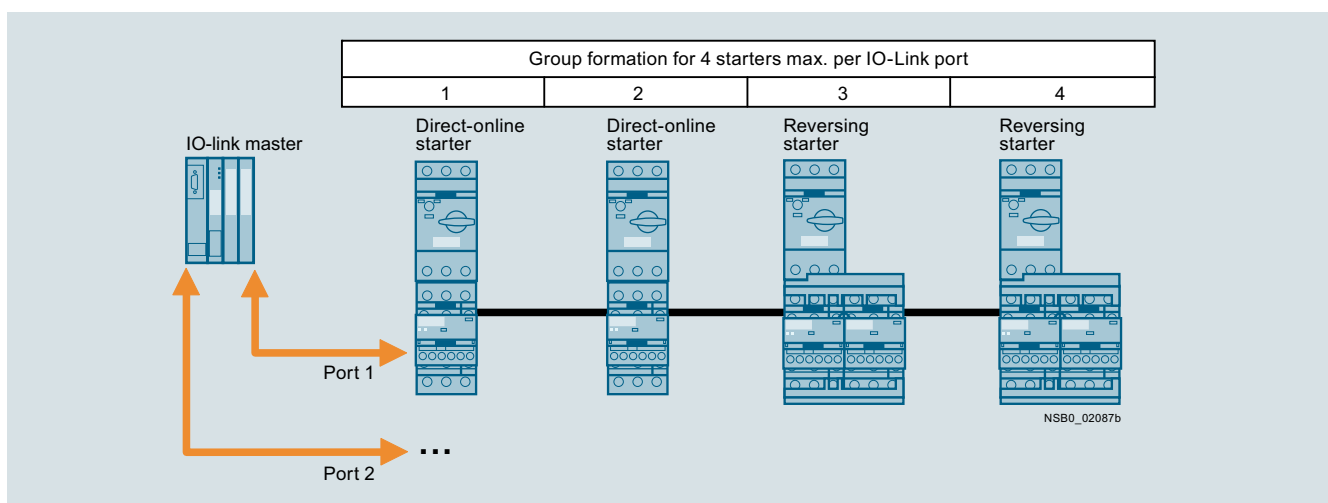

Group formation with IO-Link

In case of a malfunction, the corresponding error signals are also sent directly to the PLC in acyclic mode. This is in addition to transmission of the switching signals and status signals.

Possible error signals:

- Switching element defective
- No main voltage (motor starter protector tripped)
- No control supply voltage
- Limit position on the right/on the left
- Manual mode
- Process image fault

Switching Devices – Contactors and Contactor Assemblies – for Switching Motors

Power Contactors for Switching Motors

Accessories for SIRIUS 3RT contactors and SIRIUS 3RH2 contactor relays > General data

This easy integration of the starters in the TIA world does not limit the flexibility in the field in the least. For example, all function modules have special terminals in order to enable direct local disconnection. These terminals can be connected for example to a position switch. The input interrupts the voltage supply to the contactor coil directly, i.e. without going through the PLC. These terminals are jumpered in the as-delivered state.

Local manual operation of the complete starter group is also straightforward using a hand-held device. The latter is easily connected to the last starter and can be built into the front panel of the control cabinet if required. This offers significant advantages particularly for commissioning.

SIRIUS function modules with IO-Link are used above all in machines and plants in which there are several motor feeders in one control cabinet. Using IO-Link, the connection of these feeders to the automation level is easy, quick and error-free. And with IO modules no longer needed, the width of the PLC is far smaller.

SIRIUS 3RA2712 function modules for AS-Interface for mounting onto 3RT2 contactors

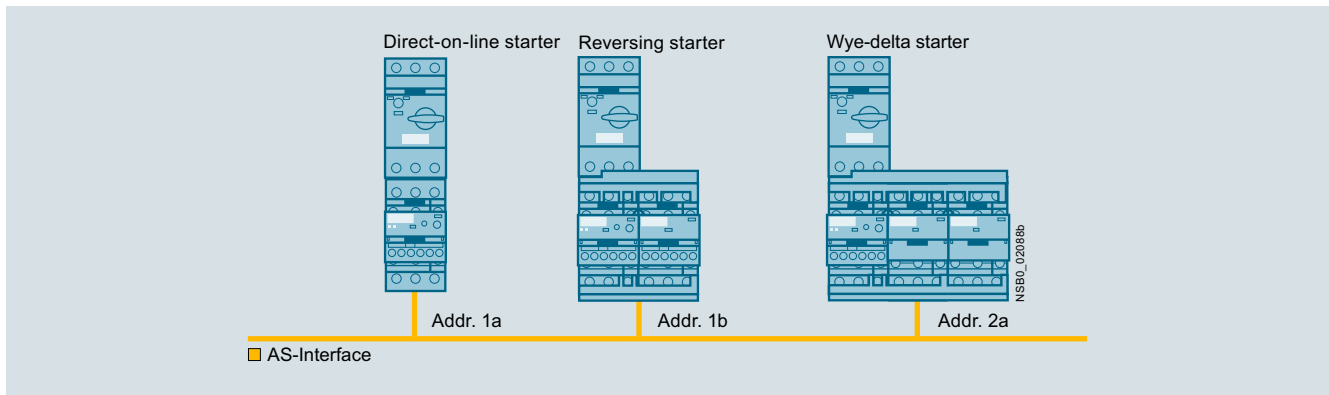

Topology with AS-Interface

This easy integration of the starters in the TIA world does not limit the flexibility in the field in the least. For example, all function modules have special terminals in order to enable direct local disconnection. These terminals can be connected for example to a position switch. The input interrupts the voltage supply to the contactor coil directly, i.e. without going through the PLC. These terminals are jumpered in the as-delivered state.

SIRIUS function modules with AS-Interface are recommended above all in machines and plants requiring easy connection of several different sensors and actuators both inside and outside the control cabinet to the higher-level control system. And with IO modules no longer needed, the width of the PLC is far smaller.

Switching Devices – Contactors and Contactor Assemblies – for Switching Motors

Power Contactors for Switching Motors

Accessories for SIRIUS 3RT contactors and SIRIUS 3RH2 contactor relays > General data

Technical specifications

More information

TIA Selection Tool Cloud (TST Cloud), see
<https://www.siemens.com/tstcloud/?node=Contactor>

Technical specifications

- For SIRIUS 3RT2 contactors and SIRIUS 3RH2 contactor relays, see
<https://support.industry.siemens.com/cs/ww/en/ps/16208/td>
- For SIRIUS 3RT1 contactors, see
<https://support.industry.siemens.com/cs/ww/en/ps/16209/td>

FAQs

- For SIRIUS 3RT2 contactors and SIRIUS 3RH2 contactor relays, see
<https://support.industry.siemens.com/cs/ww/en/ps/16208/faq>

- For SIRIUS 3RT1 contactors, see
<https://support.industry.siemens.com/cs/ww/en/ps/16209/faq>

System Manual, "SIRIUS – System Overview", see
<https://support.industry.siemens.com/cs/ww/en/view/60311318>

Equipment Manual, see "SIRIUS – SIRIUS 3RT Contactors/Contactor Assemblies", <https://support.industry.siemens.com/cs/ww/en/view/60306557>



Solid-state time-delay auxiliary switches for mounting onto 3RT201 to 3RT204 (sizes S00 to S3) and 3RH2 contactor relays (size S00)

Type		3RA2813	3RA2814	3RA2815
Function		ON-delay	OFF-delay with control signal	OFF-delay without control signal
General data				
Dimensions (basic unit with mounted solid-state time-delay auxiliary switch)		See 3RT2 contactors (pages 3/26, 3/32, 3/37, 3/42) and 3RH2 contactor relays (page 5/7)		
Rated insulation voltage U_i Pollution degree 3, overvoltage category III	V AC	300		
Rated impulse withstand voltage U_{imp}	kV AC	4		
Permissible ambient temperature				
• During operation	°C	-25 ... +60		
• During storage	°C	-40 ... +80		
Degree of protection acc. to IEC 60529		IP20		
Shock resistance Half-sine acc. to IEC 60068-2-27	g/ms	15/11		
Vibration resistance acc. to IEC 60068-2-6	Hz/mm	10 ... 55/0.35		
Electromagnetic compatibility (EMC)		IEC 61000-6-2, IEC 61000-6-4, IEC 61812-1, IEC 60947-4-1		
Overvoltage protection		Varistor integrated		
Permissible mounting position		Any (for the mounting position of 3RT2 contactors, see pages 3/26, 3/32, 3/37, 3/42; for the mounting position of 3RH2 contactor relays, see page 5/6)		
Control				
Operating range of excitation		0.85 ... 1.1 x U_s , 0.95 ... 1.05 times the rated frequency		
Rated power	W	1		
• Power consumption at 230 V AC, 50 Hz	VA	2		
Recovery time	ms	150		--
Minimum ON period	ms	--	35	200
Setting accuracy , typ., with reference to upper limit of scale		± 15%		
Repeat accuracy , max.		± 1%		
Load side				
Rated operational currents I_e				
• AC-15 at 24 ... 250 V, 50 Hz	A	3		
• DC-13	- At 24 V	A	1	
	- At 125 V	A	0.2	
	- At 250 V	A	0.1	
Mechanical endurance	Operating cycles	10 x 10 ⁶		
Electrical endurance at AC-15, 250 V, 3 A	Operating cycles	100 000		
Switching frequency for load				
• With I_e at 230 V AC	1/h	2 500		
• With 3RT2 contactor at 230 V AC	1/h	2 500		
Residual current , max.	mA	--		
Voltage drop , max., with conducting output	VA	--		
Short-circuit protection				
• Fuse links, operational class gG: DIAZED, type 5SB	A	4		

Switching Devices – Contactors and Contactor Assemblies – for Switching Motors

Power Contactors for Switching Motors

Accessories for SIRIUS 3RT contactors and SIRIUS 3RH2 contactor relays > General data

Type		3RA2813 ON-delay	3RA2814 OFF-delay with control signal	3RA2815 OFF-delay without control signal
Function				
Conductor cross-sections				
Connection type (1 or 2 conductors can be connected)		 Screw terminals		
• Solid	mm ²	1 x (0.5 ... 4), 2 x (0.5 ... 2.5)		
• Finely stranded with end sleeve (DIN 46228)	mm ²	1 x (0.5 ... 2.5), 2 x (0.5 ... 1.5)		
• AWG cables, solid or stranded	AWG	2 x (20 ... 14)		
• Terminal screws		M3 (for standard screwdriver size 2 or Pozidriv 2)		
• Tightening torque	Nm	0.8 ... 1.2		
Connection type (1 or 2 conductors can be connected)		 Spring-loaded terminals		
• Solid	mm ²	2 x (0.25 ... 1.5)		
• Finely stranded with end sleeve (DIN 46228)	mm ²	2 x (0.25 ... 1.5)		
• Finely stranded without end sleeve	mm ²	2 x (0.25 ... 1.5)		
• AWG cables, solid or stranded	AWG	2 x (24 ... 16)		
• Operating devices	mm	3.0 x 0.5		

Solid-state time-delay auxiliary switches, for snapping onto 3RT1 contactors

Type		3RT1926-2E, 3RT1926-2F, 3RT1926-2G
Sizes		S6 to S12
General data		
Dimensions (W x H x D)	mm	45 x 26 x 50
Rated insulation voltage U_i	V AC	250
Pollution degree 3 Overtoltage category III acc. to IEC 60664-1		
Permissible ambient temperature		
• During operation	°C	-25 ... +60
• During storage	°C	-40 ... +80
Degree of protection acc. to IEC 60529		
Terminals		IP20
Shock resistance Half-sine acc. to IEC 60068-2-27	g/ms	15/11
Vibration resistance acc. to IEC 60068-2-6	Hz/mm	10 ... 55/0.35
Electromagnetic compatibility (EMC)		
IEC 61812-1		
Permissible mounting position		
Any (see 3RT1 contactors, page 3/47)		
Control		
Operating range of excitation		
0.85 ... 1.1 x U_s , 0.95 ... 1.05 times the rated frequency		
Rated power	W	2
Power consumption at 230 V AC, 50 Hz	VA	4
Recovery time	ms	150
Minimum ON period	ms	200 (with OFF-delay)
Setting accuracy, typ., with reference to upper limit of scale	%	± 15
Repeat accuracy, max.	%	± 1



Type		3RT1926-2E, 3RT1926-2F, 3RT1926-2G
Sizes		S6 to S12
Load side		
Rated operational currents I_e		
• AC-15, 230 V, 50 Hz	A	3
• DC-13, 24 V	A	1
• DC-13, 110 V	A	0.2
• DC-13, 230 V	A	0.1
Short-circuit protection		
Fuse links, operational class gG: DIAZED, type 5SB	A	4
Mechanical endurance	Operating cycles	10 x 10 ⁶
Switching frequency for load		
• With I_e at 230 V AC	1/h	2 500
• With 3RT2016 contactor at 230 V AC	1/h	5 500
Conductor cross-sections		
Connection type (1 or 2 conductors can be connected)		 Screw terminals
• Solid	mm ²	2 x (0.5 ... 1.5), 2 x (0.75 ... 4)
• Finely stranded with end sleeve	mm ²	2 x (0.5 ... 2.5)
• AWG cables, solid or stranded	AWG	2 x (18 ... 14)
• Terminal screws		M3
• Tightening torque	Nm	0.8 ... 1.2

Switching Devices – Contactors and Contactor Assemblies – for Switching Motors

Power Contactors for Switching Motors

Accessories for SIRIUS 3RT contactors and SIRIUS 3RH2 contactor relays > General data

Coupling links for control by PLC



Type		3RH2924-1GP11	3RH2914-.GP11
Mounting onto contactors of size		S0	S00 to S3
General data			
Standards		IEC 60947	
Rated insulation voltage U_i (pollution degree 3)	V	300	
Protective separation between coil and contacts Acc. to IEC 60947-1, Appendix N	V AC	Up to 300	
Degree of protection acc. to IEC 60529		IP20	
Permissible ambient temperature			
• During operation	°C	-25 ... +60	
• During storage	°C	-40 ... +80	
Control side			
Rated control supply voltage U_s	V DC	24	
Operating range	V DC	17 ... 30	
Power consumption at U_s	W	0.5	
Nominal current input	mA	20	
Release voltage	V	≥ 4	
Function display		Yellow LED	
Protection circuit		Varistors	
Load side			
Mechanical endurance	Operating cycles	20 million	10 million
Electrical endurance at I_e	Operating cycles	0.1 million	
Switching frequency	1/h	5 000	
Make-time	ms	Approx. 7	
Break-time	ms	Approx. 4	
Bounce time	ms	Approx. 2	
Contact material		AgSnO ₂	
Switching voltage	V AC/DC	24 ... 250	
Rated operational current I_e			
• AC-15/AC-14 at 230 V	A	3	
• DC-13 at 230 V	A	0.1	
Permissible residual current of the electronics (with 0 signal)	mA	2.5	
Conductor cross-sections			
Connection type (1 or 2 conductors can be connected)		 Screw terminals	
• Solid	mm ²	2 x (0.5 ... 2.5)	
• Finely stranded with end sleeve (DIN 46228)	mm ²	2 x (0.5 ... 1.5)	
• Terminal screws		M3	
Connection type (1 or 2 conductors can be connected)		 Spring-loaded terminals	
• Solid	mm ²	--	2 x (0.25 ... 1.5)
• Finely stranded with end sleeve (DIN 46228)	mm ²	--	2 x (0.25 ... 1.5)
• Finely stranded without end sleeve	mm ²	--	2 x (0.25 ... 1.5)
• AWG cables, solid or stranded	AWG	--	2 x (24 ... 16)
• Operating devices	mm	--	3.0 x 0.5

Switching Devices – Contactors and Contactor Assemblies – for Switching Motors

Power Contactors for Switching Motors

Accessories for SIRIUS 3RT contactors and SIRIUS 3RH2 contactor relays > General data

3RA28 function modules for mounting onto 3RT2 contactors and 3RH2 contactor relays



Type	3RA2811	3RA2831	3RA2812	3RA2832	3RA2816
Mounting onto contactors of size	S00, S0	S2, S3	S00, S0	S2, S3	S00 to S3
Function	For direct-on-line starting				For star-delta (wye-delta) starting
	ON-delay		OFF-delay with control signal		
General data					
Dimensions (basic unit with mounted function module)					
See 3RT2 contactors (pages 3/26, 3/32, 3/37, 3/42) and 3RH2 contactor relays (page 5/7)					
Rated insulation voltage U_i Pollution degree 3 Overvoltage category III	V AC	300			
Rated impulse withstand voltage U_{imp}	kV AC	4			
Overvoltage protection	Varistor integrated				
Recovery time	ms	50			150
Minimum ON period	ms	--	35	--	
Setting accuracy Typ. With reference to upper limit of scale		± 15%			
Repeat accuracy Max.		± 1%			
Degree of protection acc. to IEC 60529	IP20				
Permissible ambient temperature					
• During operation	°C	-25 ... +60			
• During storage	°C	-40 ... +80			
Shock resistance Half-sine acc. to IEC 60068-2-27	g/ms	15/11			
Vibration resistance acc. to IEC 60068-2-6	Hz/mm	10 ... 55/0.35			
Electromagnetic compatibility (EMC)	IEC 61000-6-2, IEC 61000-6-4, IEC 61812-1, IEC 60947-4-1				
Permissible mounting position	Any (for the mounting position of 3RT2 contactors, see pages 3/26, 3/32, 3/37, 3/42; for the mounting position of 3RH2 contactor relays, see page 5/6)				
Control side					
Operating range of excitation					
0.85 ... 1.1 x U_n , 0.95 ... 1.05 times the rated frequency					
Rated power	W	1			
• Power consumption at 230 V AC, 50 Hz	VA	1			2
Load side					
Mechanical endurance	Operating cycles	100 x 10 ⁶			10 x 10 ⁶
Electrical endurance					
• With 3RT2028 contactor	Operating cycles	100 000	--		
• At AC-15, 250 V, 3 A	Operating cycles	--	100 000		
Switching frequency for load					
• With I_g at 230 V AC	1/h	2 500	--		
• With 3RT2 contactor at 230 V AC	1/h	2 500	--		
Residual current Max.	mA	5	--	--	
Voltage drop Max. With conducting output	VA	3.5	--	--	
DIAZED fuse protection	Operational class gG	A	--	4	
Conductor cross-sections					
Connection type (1 or 2 conductors can be connected)					
 Screw terminals					
• Solid	mm ²	1 x (0.5 ... 4), 2 x (0.5 ... 2.5)		--	
• Finely stranded with end sleeve (DIN 46228)	mm ²	1 x (0.5 ... 2.5), 2 x (0.5 ... 1.5)		--	
• AWG cables, solid or stranded	AWG	2 x (20 ... 14)		--	
• Terminal screws		M3 (for standard screwdriver size 2 or Pozidriv 2)		--	
• Tightening torque	Nm	0.8 ... 1.2		--	
Connection type (1 or 2 conductors can be connected)					
 Spring-loaded terminals					
• Operating devices	mm	3.0 x 0.5		--	
• Solid	mm ²	2 x (0.25 ... 1.5)		--	
• Finely stranded with end sleeve (DIN 46228)	mm ²	2 x (0.25 ... 1.5)		--	
• Finely stranded without end sleeve	mm ²	2 x (0.25 ... 1.5)		--	
• AWG cables, solid or stranded	AWG	2 x (24 ... 16)		--	

Switching Devices – Contactors and Contactor Assemblies – for Switching Motors



Power Contactors for Switching Motors

Accessories for SIRIUS 3RT contactors and SIRIUS 3RH2 contactor relays > General data

3RA27 function modules for IO-Link for mounting onto 3RT2 contactors

Type	3RA2711		
General data			
Dimensions	See 3RT2 contactors: pages 3/26, 3/32, 3/37 and 3/42		
Suitable for IO-Link masters acc. to specification	1.1		
Permissible ambient temperature			
• During operation	Acc. to IEC 60947-1	°C	-25 ... +60
• During storage	Acc. to IEC 60721-3-1	°C	-40 ... +80
• During transport	Acc. to IEC 60721-3-2	°C	-40 ... +80
Degree of protection			
IP20			
Operating voltage U_{Hi}			
V DC		24 ± 20%	
Max. length of the cables for the input Y1-Y2			
m		30	
Electromagnetic compatibility (EMC)			
IEC 61000-6-2, IEC 61000-6-4, IEC 60947-4-1			
Conductor cross-sections			
Connection type (1 or 2 conductors can be connected)			
 Screw terminals			
• Solid	mm ²	1 x (0.5 ... 4), 2 x (0.5 ... 2.5)	
• Finely stranded with end sleeve (DIN 46228)	mm ²	1 x (0.5 ... 2.5), 2 x (0.5 ... 1.5)	
• AWG cables, solid or stranded	AWG	2 x (20 ... 14)	
• Terminal screws		M3 (for standard screwdriver Ø 6 mm or Pozidriv 2)	
• Tightening torque of the terminal screws	Nm	0.8 ... 1.2	
Connection type (1 or 2 conductors can be connected)			
 Spring-loaded terminals			
• Operating devices	mm	3.0 x 0.5	
• Solid	mm ²	2 x (0.25 ... 1.5)	
• Finely stranded with end sleeve (DIN 46228)	mm ²	2 x (0.25 ... 1.5)	
• Finely stranded without end sleeve	mm ²	2 x (0.25 ... 1.5)	
• AWG cables, solid or stranded	AWG	2 x (24 ... 16)	

3RA27 function modules for AS-Interface for mounting onto 3RT2 contactors

Type	3RA2712		
General data			
Dimensions	See 3RT2 contactors: pages 3/26, 3/32, 3/37 and 3/42		
Slave type	A/B slave		
Suitable for AS-i masters acc. to specification	2.1 or higher		
AS-i slave profile IO.ID.ID2			
7.A.E			
ID1 code (factory setting)			
7			
Permissible ambient temperature			
• During operation	Acc. to IEC 60947-1	°C	-25 ... +60
• During storage	Acc. to IEC 60721-3-1	°C	-40 ... +80
• During transport	Acc. to IEC 60721-3-2	°C	-40 ... +80
Degree of protection			
IP20			
Operational voltage			
• AS-Interface	V	26.5 ... 31.6	
• AUX PWR 24 V DC	V	24 ± 20%	
Current consumption, max.			
• AS-Interface	mA	30	
• AUX PWR			
- Maximum pickup/hold current	Size S00	mA	200/200
	Size S0	mA	300/300
	Size S2	mA	1 300/50
	Size S3	mA	4 000/70
Max. length of the cables for the input Y1-Y2			
m		30	
Electromagnetic compatibility (EMC)			
IEC 61000-6-2, IEC 61000-6-4, IEC 60947-4-1			
Conductor cross-sections			
Connection type (1 or 2 conductors can be connected)			
 Screw terminals			
• Solid	mm ²	1 x (0.5 ... 4), 2 x (0.5 ... 2.5)	
• Finely stranded with end sleeve (DIN 46228)	mm ²	1 x (0.5 ... 2.5), 2 x (0.5 ... 1.5)	
• AWG cables, solid or stranded	AWG	2 x (20 ... 14)	
• Terminal screws		M3 (for standard screwdriver Ø 6 mm or Pozidriv 2)	
• Tightening torque of the terminal screws	Nm	0.8 ... 1.2	
Connection type (1 or 2 conductors can be connected)			
 Spring-loaded terminals			
• Operating devices	mm	3.0 x 0.5	
• Solid	mm ²	2 x (0.25 ... 1.5)	
• Finely stranded with end sleeve (DIN 46228)	mm ²	2 x (0.25 ... 1.5)	
• Finely stranded without end sleeve	mm ²	2 x (0.25 ... 1.5)	
• AWG cables, solid or stranded	AWG	2 x (24 ... 16)	

Switching Devices – Contactors and Contactor Assemblies – for Switching Motors

Power Contactors for Switching Motors

Accessories for SIRIUS 3RT contactors and SIRIUS 3RH2 contactor relays > Auxiliary switches, instantaneous

Selection and ordering data

Auxiliary switch: Terminal designations and identification numbers for auxiliary contacts

Terminal designations

The terminal designations are 2-digit, e.g. 13, 14, 21, 22:

- Tens digit: Sequence digit
 - Related terminals have the same sequence digit
- Units digit: Function digit
 - 1-2 for normally closed contacts (NC)
 - 3-4 for normally open contacts (NO)

Identification numbers

The identification number indicates the number and type of the auxiliary contacts, e.g. 40, 31, 22, 13:

- 1st digit: number of normally open contacts (NO)
- 2nd digit: number of normally closed contacts (NC)

Examples:

- 31 = 3 NO + 1 NC
- 40 = 4 NO

Selection aid for mountable auxiliary switches for power contactors and contactor relays

The auxiliary switches of the 3RH29 series for mounting onto the front and side can be used for 3RT2 power contactors as well as for 3RH2 contactor relays.

The possible combinations of basic unit and mounted auxiliary switch can be found in the tables, [see the following pages](#).

Where the columns and lines intersect (blue and green in the example) you will find the identification number for the combination of basic unit (column) and auxiliary switch (line).

Additional auxiliary switches		3-pole contactors		
Article number	Auxiliary contacts	3RT201	3RT201	3RT202 to 3RT204
Version		S00	S00	S0 to S3
NO NC		10	01	11
		13 14	21 22	13 21 14 22
		2. 3. 4. 5.	5. 6. 7. 8.	3. 4. 5. 6.
According to EN 50012¹⁾				
Auxiliary switches without NO contact				
3RH2911-□HA01	-- 1		11	02 12
3RH2911-□HA02	-- 2		12	03 13
3RH2911-□HA03	-- 3		13	04 14
3RH2911-□FA04	-- 4		14	-- --
Auxiliary switch with 1 NO contact				
3RH2911-□HA10	1 --		20	11 21

- 1** For screw terminals
- 2** For spring-loaded terminals

¹⁾ Combinations according to EN 50012, EN 50011 and IEC 60947-5-1 are in **bold** print. All combinations comply with EN 50005.

Example 1

Basic unit: 3-pole 3RT2017 motor contactor with 1 NO
 Required: 1 NO + 4 NC (Ident. No. 14)
 Result: 3RH2911-.FA04 auxiliary switch

Example 2

Basic unit: 3-pole 3RT2023 motor contactor with 1 NO + 1 NC
 Required: 1 NO + 4 NC (Ident. No. 14)
 Result: 3RH2911-.HA03 auxiliary switch

	Example 1	Example 2
Type	3RT20 motor contactor, S00 with 1 NO	3RT20 motor contactor, S0 with 1 NO + 1 NC
Sequence digit	2. 3. 4. 5.	3. 4. 5. 6.
Type	Auxiliary switch with 4 NC, 3RH2911-.FA04	Auxiliary switch with 3 NC, 3RH2911-.HA03
Function digit	.1 .1 .1 .1 .2 .2 .2 .2	.1 .1 .1 .2 .2 .2
Combination	3RT20 motor contactor, S00 with aux. switch	3RT20 motor contactor, S0 with aux. switch
Terminal designation	13 21 31 41 51 14 22 32 42 52	13 21 31 41 51 14 22 32 42 52
Result	Ident. No. 14	Ident. No. 14

Switching Devices – Contactors and Contactor Assemblies – for Switching Motors

Power Contactors for Switching Motors

Accessories for SIRIUS 3RT contactors and SIRIUS 3RH2 contactor relays > Auxiliary switches, instantaneous

Additional auxiliary switches		3-pole contactors			4-pole contactors				Contactor relays		
Article number	Auxiliary contacts Version	S00 3RT201	S0 to S3 3RT202, 3RT203, 3RT204, 3RT244	S00 3RT231	3RT251	S0 to S3 3RT232, 3RT233, 3RT234	3RT252, 3RT253, 3RT254	S00 3RH21, 3RH24			
	NO NC	10	01	11	--	--	11	11	40E	31E	22E
		2, 3, 4, 5.	5, 6, 7, 8.	3, 4, 5, 6.	1, 2, 3, 4.	1, 2, 3, 4.	3, 4, 5, 6.	3, 4, 5, 6.	5, 6, 7, 8.	5, 6, 7, 8.	5, 6, 7, 8.
		According to EN 50012¹⁾			According to EN 50012¹⁾				According to EN 50011¹⁾		

Auxiliary switches, front

Without NO contact

3RH2911-□HA01	-- 1		11	02	12	01	01	12	12	41X	32X	23X
3RH2911-□HA02	-- 2		12	03	13	02	02	13	--	42E	33X	24
3RH2911-□HA03	-- 3		13	04	14	03	--	--	--	43	34	--
3RH2911-□FA04	-- 4		14	--	--	--	--	--	--	44E	--	--

With 1 NO contact

3RH2911-□HA10	1 --		20	11	21	10	10	21	21	50E	41E	32E
3RH2911-□HA11	1 1		21	12	22	11	11	22	22	51X	42X	33X
3RH2911-□HA12	1 2		22	13	23	12	12	23	--	52	43	34
3RH2911-□HA13	1 3		23	14	24	13	--	--	--	53X	44X	--

With 2 NO contacts

3RH2911-□HA20	2 --		30	21	31	20	20	31	31	60E	51X	42X
3RH2911-□HA21	2 1		31	22	32	21	21	32	32	61	52	43
3RH2911-□HA22	2 2		32	23	33	22	22	33	--	62X	53	44X
3RH2911-□FA22	2 2		32	23	33	22	22	33	--	62X	53	44X

With 3 NO contacts

3RH2911-□HA30	3 --		40	31	41	30	30	41	41	70	61	52
3RH2911-□HA31	3 1		41	32	42	31	31	42	42	71X	62X	53X

With 4 NO contacts









3RH2911-□FA40	4 --		50	41	51	40	40	51	51	80E	71X	62X
----------------------	------	--	----	----	----	----	----	----	----	------------	------------	------------

¹⁾ Combinations according to EN 50012, EN 50011 and IEC 60947-5-1 are in **bold** print. All combinations comply with EN 50005.

Switching Devices – Contactors and Contactor Assemblies – for Switching Motors



Power Contactors for Switching Motors

Accessories for SIRIUS 3RT contactors and SIRIUS 3RH2 contactor relays > Auxiliary switches, instantaneous









Additional auxiliary switches		3-pole contactors			4-pole contactors				Contactor relays				
Article number	Auxiliary contacts Version	S00 3RT201	S0 to S3 3RT202, 3RT203, 3RT204, 3RT244	S00	3RT231	3RT251	S0 to S3 3RT232, 3RT233, 3RT234	3RT252, 3RT253, 3RT254	S00 3RH21, 3RH24				
	NO NC	S00	S0 to S3	S00			S0 to S3			40E	31E	22E	
													
		2. 3. 4. 5.	5. 6. 7. 8.	3. 4. 5. 6.			1. 2. 3. 4.	1. 2. 3. 4.	3. 4. 5. 6.	3. 4. 5. 6.	5. 6. 7. 8.	5. 6. 7. 8.	5. 6. 7. 8.
		According to EN 50005			According to EN 50005				According to EN 50005				

Auxiliary switches, front (continued)

With make-before-break¹⁾

3RH2911-□FB11	1	1		21	12	22	11	11	22	22	51	42	33
3RH2911-□FB22	2	2		32	23	33	22	22	33	--	62	53	44
3RH2911-□FC22	2	2		32	23	33	22	22	33	--	62	53	44

Complete inscription with terminals from top or bottom

3RH2911-1AA10	1	--		20	11	21	10	10	21	21	50	41	32
3RH2911-1BA10	1	--		20	11	21	10	10	21	21	50	41	32
3RH2911-1AA01	--	1		11	02	12	01	01	12	12	41	32	23
3RH2911-1BA01	--	1		11	02	12	01	01	12	12	41	32	23
3RH2911-1LA11	1	1		21	12	22	11	11	22	22	51	42	33
3RH2911-1MA11	1	1		21	12	22	11	11	22	22	51	42	33
3RH2911-1LA20	2	--		30	21	31	20	20	31	31	60	51	42
3RH2911-1MA20	2	--		30	21	31	20	20	31	31	60	51	42

¹⁾ Contacts with make-before-break have no mirror contact function.

Switching Devices – Contactors and Contactor Assemblies – for Switching Motors

Power Contactors for Switching Motors

Accessories for SIRIUS 3RT contactors and SIRIUS 3RH2 contactor relays > Auxiliary switches, instantaneous

Additional auxiliary switches		3-pole contactors			4-pole contactors				Contactor relays		
Article number	Auxiliary contacts Version	S00 3RT201	S0 to S3 3RT202, 3RT203, 3RT204, 3RT244		S00 3RT231	3RT251	S0 to S3 3RT232, 3RT252, 3RT233, 3RT253, 3RT234, 3RT254		S00 3RH21, 3RH24		
	NO NC	10	01	11	--	--	11	11	40E	31E	22E
		2. 3. 4. 5.	5. 6. 7. 8.	3. 4. 5. 6.	1. 2. 3. 4.	1. 2. 3. 4.	3. 4. 5. 6.	3. 4. 5. 6.	5. 6. 7. 8.	5. 6. 7. 8.	5. 6. 7. 8.
		According to EN 50005			According to EN 50005				According to EN 50011 ¹⁾		

Auxiliary switches, front (continued)

With complete inscription (for contactor relays)²⁾

3RH2911-□GA40	4	--		--	--	--	--	--	--	80E	--	--
3RH2911-□GA31	3	1		--	--	--	--	--	--	71E	--	--
3RH2911-□GA22	2	2		--	--	--	--	--	--	62E	--	--
3RH2911-□GA13	1	3		--	--	--	--	--	--	53E	--	--
3RH2911-□GA04	--	4		--	--	--	--	--	--	44E	--	--

Complete inscription

3RH2911-□XA40-0MA0	4	--		50	41	51	40	40	51	51	80E	71X	62X
3RH2911-□XA31-0MA0	3	1		41	32	42	31	31	42	42	71E	62X	53
3RH2911-□XA22-0MA0	2	2		32	23	33	22	22	33	--	62E	53	44X
3RH2911-□XA04-0MA0	--	4		14	--	--	--	--	--	--	44E	--	--

Solid-state compatible

3RH2911-□NF02	--	2		12	03	13	02	02	13	--	42	33	24
3RH2911-□NF11	1	1		21	12	22	11	11	22	22	51	42	33
3RH2911-□NF20	2	--		30	21	31	20	20	31	31	60	51	42









¹⁾ Combinations according to EN 50011 and IEC 60947-5-1 are in **bold** print.
All combinations comply with EN 50005.

²⁾ For selection and ordering data, see page 3/95.





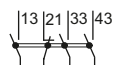









Switching Devices – Contactors and Contactor Assemblies – for Switching Motors









Power Contactors for Switching Motors

Accessories for SIRIUS 3RT contactors and SIRIUS 3RH2 contactor relays > Auxiliary switches, instantaneous

Additional auxiliary switches		3-pole contactors			4-pole contactors				Contactor relays								
Article number	Auxiliary contacts Version	S00			S0 to S3				S00								
		3RT201			3RT202, 3RT203, 3RT204, 3RT244				3RT231 3RT251			3RT232, 3RT233, 3RT234 3RT252, 3RT253, 3RT254			3RH21		
	NO NC	10	01	11	--	--	11	11	40E	31E	22E						
																	
		2. 3. 4. 5.	5. 6. 7. 8.	3. 4. 5. 6.			1. 2. 3. 4.	1. 2. 3. 4.	3. 4. 5. 6.	3. 4. 5. 6.	5. 6. 7. 8.						
		According to EN 50012 ¹⁾			According to EN 50012 ¹⁾				According to EN 50011 ¹⁾								

Lateral auxiliary switches

For size S00		Left	Right										
3RH2911-□DA02	-- 2			12	--	--	02	02	--	--	--	--	--
3RH2911-□DA02	-- 2			14	--	--	--	--	--	--	--	--	--
3RH2911-□DA11	1 1			21	--	--	11	11	--	--	--	--	--
3RH2911-□DA11	1 1			32	--	--	22	22	--	--	--	--	--
3RH2911-□DA20	2 --			30	--	--	20	20	--	--	--	--	--
3RH2911-□DA20	2 --			50	--	--	40	40	--	--	--	--	--
3RH2911-□DA20	2 --			41	--	--	31	31	--	--	--	--	--
3RH2911-□DA20	2 --			32	--	--	22	22	--	--	--	--	--
3RH2911-□DA20	2 --			23	--	--	13	--	--	--	--	--	--

For sizes S00 to S3		Left	Right										
3RH2921-□DA02	-- 2			12	03	13	02	02	13	--	--	--	--
3RH2921-□DA02	-- 2			14	--	--	--	--	--	--	--	--	--
3RH2921-□DA11	1 1			21	12	22	11	11	22	22	--	--	--
3RH2921-□DA11	1 1			32	23	33	22	22	--	--	--	--	--
3RH2921-□DA20	2 --			30	21	31	20	20	31	31	--	--	--
3RH2921-□DA20	2 --			50	41	51	40	40	--	--	--	--	--

¹⁾ Combinations according to EN 50012, EN 50011 and IEC 60947-5-1 are in **bold** print. All combinations comply with EN 50005.

Switching Devices – Contactors and Contactor Assemblies – for Switching Motors

Power Contactors for Switching Motors

Accessories for SIRIUS 3RT contactors and SIRIUS 3RH2 contactor relays > Auxiliary switches, instantaneous

Additional auxiliary switches		3-pole contactors			4-pole contactors				Contactor relays		
Article number	Auxiliary contacts Version	S00 3RT201	S0 to S3 3RT202, 3RT203, 3RT204, 3RT244	S00 3RT231	3RT251	S0 to S3 3RT232, 3RT233, 3RT234	3RT252, 3RT253, 3RT254	S00 3RH21			
	NO NC	10	01	11	--	--	11	11	40E	31E	22E
		2. 3. 4. 5.	5. 6. 7. 8.	3. 4. 5. 6.	1. 2. 3. 4.	1. 2. 3. 4.	3. 4. 5. 6.	3. 4. 5. 6.	5. 6. 7. 8.	5. 6. 7. 8.	5. 6. 7. 8.
		According to EN 50012¹⁾			According to EN 50012¹⁾				According to EN 50011¹⁾		

Lateral auxiliary switches (continued)

For sizes S00 to S3		Left	Right	3-pole contactors			4-pole contactors				Contactor relays		
3RH2921-□DA20	2 --			41	32	42	31	31	--	--	--	--	--
3RH2921-□DA11	1 1												
3RH2921-□DA20	2 --			32	23	33	22	22	--	--	--	--	--
3RH2921-□DA02	-- 2												
3RH2921-□DA11	1 1			23	14	24	13	--	--	--	--	--	--
3RH2921-□DA02	-- 2												

For contactor relays ²⁾		Left	3-pole contactors			4-pole contactors				Contactor relays		
3RH2921-□DA02	-- 2		--	--	--	--	--	--	--	42Z	33X	24
3RH2921-□DA11	1 1		--	--	--	--	--	--	--	51X	42X	33X
3RH2921-□DA20	2 --		--	--	--	--	--	--	--	60Z	51X	42X

Solid-state compatible

For size S00		Left	Right	3-pole contactors			4-pole contactors				Contactor relays		
3RH2911-2DE11	1 1			21	--	--	11	11	--	--	--	--	--
3RH2911-2DE11	1 1			32	--	--	22	22	--	--	--	--	--
3RH2911-2DE11	1 1												

For sizes S00 to S3		Left	Right	3-pole contactors			4-pole contactors				Contactor relays		
3RH2921-□DE11	1 1			21	12	22	11	11	22	22	--	--	--
3RH2921-□DE11	1 1			32	23	33	22	22	--	--	--	--	--
3RH2921-□DE11	1 1												

For contactor relays ²⁾		Left	3-pole contactors			4-pole contactors				Contactor relays		
3RH2921-2DE11	1 1		--	--	--	--	--	--	--	51X	42X	33X

¹⁾ Combinations according to EN 50012, EN 50011 and IEC 60947-5-1 are in **bold** print. All combinations comply with EN 50005.

²⁾ Without positively driven operation.

Switching Devices – Contactors and Contactor Assemblies – for Switching Motors

Power Contactors for Switching Motors

Accessories for SIRIUS 3RT contactors and SIRIUS 3RH2 contactor relays > Auxiliary switches, instantaneous

PU (UNIT, SET, M) = 1
 PS* = 1 unit
 PG = 41B



3RH2911-1HA22



3RH2911-2HA22

For contactors/ contactor relays ¹⁾	Auxiliary contacts Version	SD	Screw terminals		SD	Spring-loaded terminals	
			Article No.	Price per PU		Article No.	Price per PU
Type	NO NC	d			d		

Auxiliary switches for snapping onto the front

Sizes S00 to S3

3RT2.1, 3RT2.2, 3RT2.3, 3RT2.4	--	1		▶	3RH2911-1HA01	▶	3RH2911-2HA01
3RH21, 3RH24	--	2		▶	3RH2911-1HA02	▶	3RH2911-2HA02
	--	3		▶	3RH2911-1HA03	▶	3RH2911-2HA03
	1	--		▶	3RH2911-1HA10	▶	3RH2911-2HA10
	1	1		▶	3RH2911-1HA11	▶	3RH2911-2HA11
	1	2		▶	3RH2911-1HA12	▶	3RH2911-2HA12
	1	3		▶	3RH2911-1HA13	▶	3RH2911-2HA13
	2	--		▶	3RH2911-1HA20	▶	3RH2911-2HA20
	2	1		▶	3RH2911-1HA21	▶	3RH2911-2HA21
	2	2		▶	3RH2911-1HA22	▶	3RH2911-2HA22
	3	--		▶	3RH2911-1HA30	▶	3RH2911-2HA30
	3	1		▶	3RH2911-1HA31	▶	3RH2911-2HA31

¹⁾ For detailed information on use, see page 3/88.

Switching Devices – Contactors and Contactor Assemblies – for Switching Motors

Power Contactors for Switching Motors

Accessories for SIRIUS 3RT contactors and SIRIUS 3RH2 contactor relays > Auxiliary switches, instantaneous

PU (UNIT, SET, M) = 1
 PS* = 1 unit
 PG = 41B



3RH2911-1FC22



3RH2911-2FC22



3RH2911-1AA01



3RH2911-1BA01



3RH2911-1LA11



3RH2911-1MA11

For contactors/ contactor relays ¹⁾	Connections Position	Auxiliary contacts Version	SD	Screw terminals	SD	Spring-loaded terminals	
Type		NO NC NO NC	d	Article No.	Price per PU	Article No.	Price per PU

Auxiliary switches for snapping onto the front

Sizes S00 to S3

3RT2.1, 3RT2.2, 3RT2.3, 3RT2.4	--	4	--	--	--		▶ 3RH2911-1FA40	▶ 3RH2911-2FA40
3RH21, 3RH24	--	2	2	--	--		▶ 3RH2911-1FA22	▶ 3RH2911-2FA22
	--	--	4	--	--		▶ 3RH2911-1FA04	▶ 3RH2911-2FA04
	--	--	--	1	1		▶ 3RH2911-1FB11	▶ 3RH2911-2FB11
	--	1	1	1	1		▶ 3RH2911-1FB22	▶ 3RH2911-2FB22
	--	--	--	2	2		▶ 3RH2911-1FC22	▶ 3RH2911-2FC22

1- and 2-pole auxiliary switches, cable entry from top or bottom

3RT2.1, 3RT2.2, 3RT2.3, 3RT2.4	Top	1	--	--	--		▶ 3RH2911-1AA10	--
	Bottom	1	--	--	--		▶ 3RH2911-1BA10	--
3RH21, 3RH24	Top	--	1	--	--		▶ 3RH2911-1AA01	--
	Bottom	--	1	--	--		▶ 3RH2911-1BA01	--
	Top	1	1	--	--		▶ 3RH2911-1LA11	--
	Bottom	1	1	--	--		▶ 3RH2911-1MA11	--
	Top	2	--	--	--		▶ 3RH2911-1LA20	--
	Bottom	2	--	--	--		▶ 3RH2911-1MA20	--

¹⁾ For detailed information on use, see pages 3/88 and 3/89.

Switching Devices – Contactors and Contactor Assemblies – for Switching Motors

Power Contactors for Switching Motors

Accessories for SIRIUS 3RT contactors and SIRIUS 3RH2 contactor relays > Auxiliary switches, instantaneous

PU (UNIT, SET, M) = 1
 PS* = 1 unit
 PG = 41B



3RH2911-1GA22



3RH2911-2GA22

For contactor relays ¹⁾	Contactor relay with auxiliary switch Ident. No.	Auxiliary contacts Version	SD	Screw terminals	SD	Spring-loaded terminals
Type		NO NC	d	Article No. Price per PU	d	Article No. Price per PU

Auxiliary switches for snapping onto the front

Size S00

Blocks for the assembly of contactor relays with 8 contacts

3RH2140, 3RH2440, Ident. No. 40E	80E	4	--		▶	3RH2911-1GA40	▶	3RH2911-2GA40
	71E	3	1		▶	3RH2911-1GA31	▶	3RH2911-2GA31
	62E	2	2		▶	3RH2911-1GA22	▶	3RH2911-2GA22
	53E	1	3		▶	3RH2911-1GA13	▶	3RH2911-2GA13
	44E	--	4		▶	3RH2911-1GA04	▶	3RH2911-2GA04

¹⁾ For detailed information on use, see page 3/90.

PU (UNIT, SET, M) = 1
 PS* = 1 unit
 PG = 41B



3RH2911-1XA22-0MA0



3RH2911-2XA22-0MA0

For contactors/ contactor relays ¹⁾	Auxiliary contacts Version	SD	Screw terminals	SD	Spring-loaded terminals
Type	NO NC	d	Article No. Price per PU	d	Article No. Price per PU

Auxiliary switches for snapping onto the front

Sizes S00 to S3

3RT2.1, 3RT2.2, 3RT2.3, 3RT2.4	4	--		▶	3RH2911-1XA40-0MA0	▶	3RH2911-2XA40-0MA0
3RH21, 3RH24	3	1		▶	3RH2911-1XA31-0MA0	▶	3RH2911-2XA31-0MA0
	2	2		▶	3RH2911-1XA22-0MA0	▶	3RH2911-2XA22-0MA0
	--	4		▶	3RH2911-1XA04-0MA0	5	3RH2911-2XA04-0MA0

¹⁾ For detailed information on use, see page 3/90.

Switching Devices – Contactors and Contactor Assemblies – for Switching Motors

Power Contactors for Switching Motors

Accessories for SIRIUS 3RT contactors and SIRIUS 3RH2 contactor relays > Auxiliary switches, instantaneous

PU (UNIT, SET, M) = 1
 PS* = 1 unit
 PG = 41B

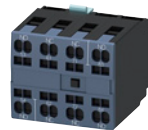

3RH1921-1XA22-0MA0

3RH1921-2XA22-0MA0

3RH1921-1CA10 3RH1921-1CD10

3RH1921-2CA10 3RH1921-2CA01

For contactors	Auxiliary contacts		SD	Screw terminals		SD	Spring-loaded terminals	
	Ident. No.	Version		Article No.	Price per PU		Article No.	Price per PU
Type		NO NC NO NC	d			d		

Auxiliary switches for snapping onto the front

Sizes S6 to S12

4-pole auxiliary switches

• According to EN 50012

3RT1.5 ... 3RT1.7	22	2	2	--	--		5	3RH1921-1XA22-0MA0	20	3RH1921-2XA22-0MA0
----------------------	----	---	---	----	----	--	---	--------------------	----	--------------------

1-pole auxiliary switches

• According to EN 50005 and EN 50012

3RT1.5 ... 3RT1.7	10	1	--	--	--			3RH1921-1CA10		3RH1921-2CA10
	01	--	1	--	--			3RH1921-1CA01		3RH1921-2CA01
	10	--	--	1	--			3RH1921-1CD10	--	--
	01	--	--	--	1			3RH1921-1CD01	--	--

Switching Devices – Contactors and Contactor Assemblies – for Switching Motors

Power Contactors for Switching Motors

Accessories for SIRIUS 3RT contactors and SIRIUS 3RH2 contactor relays > Auxiliary switches, instantaneous

PU (UNIT, SET, M) = 1
 PS* = 1 unit
 PG = 41B



3RH2911-1DA02



3RH2911-2DA02

For contactors ¹⁾	Auxiliary contacts Version	SD	Screw terminals	SD	Spring-loaded terminals
	NO NC		Article No.	Price per PU	Article No.
Type		d		d	

Laterally mountable auxiliary switches, mounting onto the right and/or the left, 2-pole

Size S00

		Left	Right					
3RT2.1	--	2			2	3RH2911-1DA02	2	3RH2911-2DA02
	1	1			2	3RH2911-1DA11	2	3RH2911-2DA11
	2	--			2	3RH2911-1DA20	2	3RH2911-2DA20

Sizes S0 to S3

		Left	Right					
3RT2.1 3RT2.2 ²⁾ 3RT2.3 ³⁾ 3RT2.4 ³⁾	--	2			2	3RH2921-1DA02	2	3RH2921-2DA02
	1	1			2	3RH2921-1DA11	2	3RH2921-2DA11
	2	--			2	3RH2921-1DA20	2	3RH2921-2DA20

¹⁾ For detailed information on use, see pages 3/91 and 3/92.

²⁾ With 3RT232. and 3RT252. contactors, mountable only on the right.

³⁾ 3RH2921-1DA.. lateral auxiliary switches can only be mounted onto 3RT26 capacitor contactors of sizes S2 and S3.

Switching Devices – Contactors and Contactor Assemblies – for Switching Motors

Power Contactors for Switching Motors

Accessories for SIRIUS 3RT contactors and SIRIUS 3RH2 contactor relays > Auxiliary switches, instantaneous

PU (UNIT, SET, M) = 1
 PS* = 1 unit
 PG = 41B



3RH1921-1DA11



3RH1921-1JA11



3RH1921-1EA02



3RH1921-1KA02



3RH1921-2DA11

For contactors	Auxiliary contacts	Version	SD	Screw terminals	SD	Spring-loaded terminals	
Type	NO	NC	d	Article No.	Price per PU	Article No.	Price per PU

Lateral auxiliary switches, mounting on right or left, 2-pole

Sizes S6 to S12

Left Right

First auxiliary switch

• According to EN 50012

3RT1.5 ...
3RT1.7

1

1

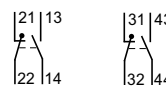

3RH1921-1DA11



3RH1921-2DA11

• According to EN 50005

3RT1.5 ...
3RT1.7

2

--

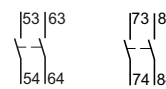

3RH1921-1EA20



3RH1921-2EA20

1

1

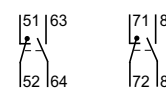

3RH1921-1EA11

--

--

2

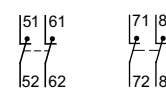

3RH1921-1EA02



3RH1921-2EA02

Second auxiliary switch

• According to EN 50012

3RT1.5 ...
3RT1.7

1

1

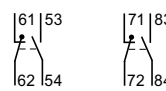

3RH1921-1JA11



3RH1921-2JA11

• According to EN 50005

3RT1.5 ...
3RT1.7

2

--

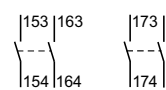

3RH1921-1KA20

20

3RH1921-2KA20

1

1

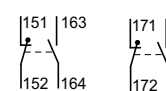

3RH1921-1KA11

--

--

2

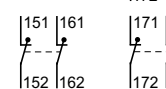

3RH1921-1KA02

20

3RH1921-2KA02

Switching Devices – Contactors and Contactor Assemblies – for Switching Motors

Power Contactors for Switching Motors

Accessories for SIRIUS 3RT contactors and SIRIUS 3RH2 contactor relays > Auxiliary switches, instantaneous

PU (UNIT, SET, M) = 1
 PS* = 1 unit
 PG = 41B



3RH2911-1NF..



3RH2911-2NF..



3RH2911-2DE11



3RH1921-2JE11

For contactors/ contactor relays ¹⁾	Size	Contacts Version		SD	Screw terminals		Spring-loaded terminals	
		NO	NC		Article No.	Price per PU	Article No.	Price per PU
				d				

Solid-state compatible auxiliary switches, 2-pole

- For operation in dusty atmospheres
- For solid-state circuits with rated operational currents I_e /AC-14 and DC-13 from 1 to 300 mA at 3 to 60 V
- Hard gold-plated contacts
- Laterally mountable auxiliary switches and auxiliary switches for snapping onto the front for 3RT2 contactors, sizes S0 to S3, are designed as mirror contacts according to IEC 60947-4-1, Appendix F.

Auxiliary switches for snapping onto the front

3RT2.1, 3RT2.2, 3RT2.3, 3RT2.4	S00 ... S3	--	2		2	3RH2911-1NF02	2	3RH2911-2NF02
3RH21, 3RH24		1	1		▶	3RH2911-1NF11	▶	3RH2911-2NF11
		2	--		▶	3RH2911-1NF20	▶	3RH2911-2NF20

Lateral auxiliary switches, mounting on the right and/or on the left, acc. to EN 50012

		Auxiliary switches		Left		Right			
3RT2.1	S00	1	1			--	2	3RH2911-2DE11	
3RT2.2, 3RT2.3, 3RT2.4	S0 ... S3	1	1			--	2	3RH2921-2DE11	
3RT1.5 ... 3RT1.7	S6 ... S12	1	1			--	▶	3RH1921-2DE11	
3RT1.5 ... 3RT1.7	S6 ... S12	1	1			--	▶	3RH1921-2JE11	

¹⁾ For detailed information on use, see pages 3/90 and 3/92.

Switching Devices – Contactors and Contactor Assemblies – for Switching Motors

Power Contactors for Switching Motors

Accessories for SIRIUS 3RT contactors and SIRIUS 3RH2 contactor relays > Auxiliary switches, delayed

Selection and ordering data

For contactors	Time setting range <i>t</i>	SD	Screw terminals	PU (UNIT, SET, M)	PS*	PG
Type	s	d	Article No.	Price per PU		
Pneumatic time-delay auxiliary switches for mounting onto 3RT2 contactors						
Size S0						
Auxiliary contacts 1 NO and 1 NC¹⁾						
ON-delay						
 3RT2926-2P...	3RT202	0.1 ... 30	10	3RT2926-2PA01	1	1 unit 41B
		0.1 ... 30 ²⁾	X	3RT2926-2PA01-OMT0	1	1 unit 41B
		1 ... 60	10	3RT2926-2PA11	1	1 unit 41B
		1 ... 60 ²⁾	X	3RT2926-2PA11-OMT0	1	1 unit 41B
OFF-delay						
	3RT202	0.1 ... 30	10	3RT2926-2PR01	1	1 unit 41B
		0.1 ... 30 ²⁾	X	3RT2926-2PR01-OMT0	1	1 unit 41B
		1 ... 60	10	3RT2926-2PR11	1	1 unit 41B
		1 ... 60 ²⁾	X	3RT2926-2PR11-OMT0	1	1 unit 41B

¹⁾ In addition to these, no other auxiliary contacts are permitted.

²⁾ Certificate for furnaces according to EN 50156-1 on request.

Technical specifications, see [Equipment Manual](#).

PU (UNIT, SET, M) = 1
PS* = 1 unit
PG = 41B



3RA2813-1FW10



3RA2813-2AW10

For contactors	Rated control supply voltage U_s ¹⁾	Time setting range <i>t</i>	Output/auxiliary contacts	SD	Screw terminals	SD	Spring-loaded terminals
Type	V	s		d	Article No.	Price per PU	Article No.
Solid-state time-delay auxiliary switches²⁾ for mounting onto 3RT2 contactors and 3RH2 contactor relays							
Sizes S00 to S3							
The electrical connection between the solid-state time-delay auxiliary switch and the contactor or contactor relay underneath is established automatically when it is snapped on and locked.							
ON-delay (varistor integrated)							
3RT2 ³⁾⁴⁾ , 3RH21 ³⁾ , 3RH24	24 ... 240 AC/DC	0.05 ... 100 (1, 10, 100 selectable)	1 CO 1 NO + 1 NC	2	3RA2813-1AW10	2	3RA2813-2AW10
				2	3RA2813-1FW10	2	3RA2813-2FW10
OFF-delay with control signal (varistor integrated)							
3RT2 ³⁾⁴⁾ , 3RH21 ³⁾ , 3RH24	24 ... 240 AC/DC	0.05 ... 100 (1, 10, 100 selectable)	1 CO 1 NO + 1 NC	2	3RA2814-1AW10	2	3RA2814-2AW10
				2	3RA2814-1FW10	2	3RA2814-2FW10
OFF-delay without control signal⁵⁾ (varistor integrated)							
3RT2 ³⁾⁴⁾ , 3RH21 ³⁾ , 3RH24	24 ... 240 AC/DC	0.05 ... 100 (1, 10, 100 selectable)	1 CO 1 NO + 1 NC	2	3RA2815-1AW10	2	3RA2815-2AW10
				2	3RA2815-1FW10	2	3RA2815-2FW10

Sizes S00 to S3

The electrical connection between the solid-state time-delay auxiliary switch and the contactor or contactor relay underneath is established automatically when it is snapped on and locked.

ON-delay
(varistor integrated)

3RT2³⁾⁴⁾,
3RH21³⁾,
3RH24

OFF-delay with control signal
(varistor integrated)

3RT2³⁾⁴⁾,
3RH21³⁾,
3RH24

OFF-delay without control signal⁵⁾
(varistor integrated)

3RT2³⁾⁴⁾,
3RH21³⁾,
3RH24

¹⁾ AC voltage values apply for 50 Hz and 60 Hz.

²⁾ The solid-state time-delay auxiliary switches are also available as 3RA28 function modules for mounting onto 3RT2 contactors and 3RH2 contactor relays, see [page 3/105](#).

³⁾ Cannot be fitted onto coupling relays and coupling contactor relays.

⁴⁾ From product version E04 onwards, 3RA281. solid-state time-delay auxiliary switches can be used for 3RT2.4 contactors.



⁵⁾ Setting of output contacts in as-supplied state not defined (bistable relay). Application of the control supply voltage once results in contact change-over to the correct setting.

Technical specifications, see [page 3/82](#).

Switching Devices – Contactors and Contactor Assemblies – for Switching Motors

Power Contactors for Switching Motors

Accessories for SIRIUS 3RT contactors and SIRIUS 3RH2 contactor relays > Auxiliary switches, delayed

For contactors	Auxiliary contacts	Rated control supply voltage U_s ¹⁾	Time setting range t	SD	Screw terminals 	PU (UNIT, SET, M)	PS*	PG	
Type		V	s	d	Article No.	Price per PU			
Solid-state time-delay auxiliary switches for mounting onto 3RT1 contactors									
Sizes S6 to S12									
ON-delay²⁾									
	3RT10, 3RT14	1 NO + 1 NC	24 AC/DC	0.05 ... 1	▶ 10	3RT1926-2EJ11	1	1 unit	41H
				0.5 ... 10	▶ 10	3RT1926-2EJ21	1	1 unit	41H
				5 ... 100	▶ 2	3RT1926-2EJ31	1	1 unit	41H
	3RT1926-2E..1, 3RT1926-2E.1	100 ... 127 AC	0.05 ... 1	0.5 ... 10	▶ 15	3RT1926-2EC11	1	1 unit	41H
						3RT1926-2EC21	1	1 unit	41H
						3RT1926-2EC31	1	1 unit	41H
3RT1926-2E..1, 3RT1926-2E.1	200 ... 240 AC	0.05 ... 1	0.5 ... 10	▶ 5	3RT1926-2ED11	1	1 unit	41H	
					3RT1926-2ED21	1	1 unit	41H	
					3RT1926-2ED31	1	1 unit	41H	
OFF-delay without control signal²⁾³⁾									
	3RT10, 3RT14	1 NO + 1 NC	24 AC/DC	0.05 ... 1	▶ 5	3RT1926-2FJ11	1	1 unit	41H
				0.5 ... 10	▶ 5	3RT1926-2FJ21	1	1 unit	41H
				5 ... 100	▶ 5	3RT1926-2FJ31	1	1 unit	41H
	3RT1926-2G.51	100 ... 127 AC/DC	0.05 ... 1	0.5 ... 10	▶ 5	3RT1926-2FK11	1	1 unit	41H
						3RT1926-2FK21	1	1 unit	41H
						3RT1926-2FK31	1	1 unit	41H
	3RT1926-2G.51	200 ... 240 AC/DC	0.05 ... 1	0.5 ... 10	▶ 5	3RT1926-2FL11	1	1 unit	41H
						3RT1926-2FL21	1	1 unit	41H
						3RT1926-2FL31	1	1 unit	41H
Star-delta (wye-delta) starting (varistor integrated)²⁾									
3RT10, 3RT14	1 NO delayed + 1 NO instantaneous, dead time 50 ms	24 AC/DC	1.5 ... 30	▶	3RT1926-2GJ51	1	1 unit	41H	
		100 ... 127 AC	1.5 ... 30	▶	3RT1926-2GC51	1	1 unit	41H	
		200 ... 240 AC	1.5 ... 30	▶	3RT1926-2GD51	1	1 unit	41H	

¹⁾ The AC voltages are valid for 50 and 60 Hz.

²⁾ Connecting terminals A1 and A2 for the control supply voltage of the solid-state time-delay auxiliary switch must be connected to the associated contactor by means of cables.

³⁾ Setting of output contacts in as-supplied state not defined (bistable relay). Application of the control supply voltage once results in contact change-over to the correct setting.

Switching Devices – Contactors and Contactor Assemblies – for Switching Motors

Power Contactors for Switching Motors

Accessories for SIRIUS 3RT contactors and SIRIUS 3RH2 contactor relays > Surge suppressors

Selection and ordering data

For contactors	Version	Rated control supply voltage $U_s^{(1)}$		SD	Article No.	Price per PU	PU (UNIT, SET, M)	PS*	PG
		AC operation	DC operation						
	Type	V AC	V DC	d					

Surge suppressors without LED (also for spring-loaded terminals)

Size S00

For plugging onto the front of the contactors (with or without auxiliary switches)

3RT2.1, 3RH2	Varistors	24 ... 48	24 ... 70	▶	3RT2916-1BB00		1	1 unit	41B
		48 ... 127	70 ... 150	▶	3RT2916-1BC00		1	1 unit	41B
		127 ... 240	150 ... 250	▶	3RT2916-1BD00		1	1 unit	41B
		240 ... 400	--	▶	3RT2916-1BE00		1	1 unit	41B
		400 ... 600	--	2	3RT2916-1BF00		1	1 unit	41B
3RT2.1, 3RH2	RC elements	24 ... 48	24 ... 70	▶	3RT2916-1CB00		1	1 unit	41B
		48 ... 127	70 ... 150	▶	3RT2916-1CC00		1	1 unit	41B
		127 ... 240	150 ... 250	▶	3RT2916-1CD00		1	1 unit	41B
		240 ... 400	--	2	3RT2916-1CE00		1	1 unit	41B
		400 ... 600	--	2	3RT2916-1CF00		1	1 unit	41B
3RT2.1, 3RH2	Noise suppression diodes	--	12 ... 250	▶	3RT2916-1DG00		1	1 unit	41B
3RT2.1, 3RH2	Diode assemblies (diode and Zener diode) for DC operation	--	12 ... 250	▶	3RT2916-1EH00		1	1 unit	41B



3RT2916-1B.00

Size S0

For plugging into the front of the contactors (before mounting the auxiliary switch)

3RT2.2	Varistors²⁾	24 ... 48	24 ... 70	▶	3RT2926-1BB00		1	1 unit	41B
		48 ... 127	70 ... 150	▶	3RT2926-1BC00		1	1 unit	41B
		127 ... 240	150 ... 250	▶	3RT2926-1BD00		1	1 unit	41B
		240 ... 400	--	▶	3RT2926-1BE00		1	1 unit	41B
		400 ... 600	--	2	3RT2926-1BF00		1	1 unit	41B
3RT2.2	RC elements	24 ... 48	24 ... 70	▶	3RT2926-1CB00		1	1 unit	41B
		48 ... 127	70 ... 150	▶	3RT2926-1CC00		1	1 unit	41B
		127 ... 240	150 ... 250	▶	3RT2926-1CD00		1	1 unit	41B
		240 ... 400	--	2	3RT2926-1CE00		1	1 unit	41B
		400 ... 600	--	2	3RT2926-1CF00		1	1 unit	41B
3RT2.2	Diode assemblies for DC operation	--	24	▶	3RT2926-1ER00		1	1 unit	41B
		--	30 ... 250	▶	3RT2926-1ES00		1	1 unit	41B



3RT2926-1E.00

Sizes S2 and S3

For plugging into the front of the contactors (before mounting the auxiliary switch)

3RT2.3, 3RT2.4	Varistors²⁾³⁾	24 ... 48	--	▶	3RT2936-1BB00		1	1 unit	41B
		48 ... 127	--	▶	3RT2936-1BC00		1	1 unit	41B
		127 ... 240	--	▶	3RT2936-1BD00		1	1 unit	41B
		240 ... 400	--	5	3RT2936-1BE00		1	1 unit	41B
		400 ... 600	--	5	3RT2936-1BF00		1	1 unit	41B
3RT2.3	RC elements	24 ... 48	24 ... 70	▶	3RT2936-1CB00		1	1 unit	41B
		48 ... 127	70 ... 150	▶	3RT2936-1CC00		1	1 unit	41B
		127 ... 240	150 ... 250	▶	3RT2936-1CD00		1	1 unit	41B
		240 ... 400	--	5	3RT2936-1CE00		1	1 unit	41B
		400 ... 600	--	5	3RT2936-1CF00		1	1 unit	41B
3RT2.3, 3RT2.4	Diode assemblies³⁾ for DC operation	--	24	▶	3RT2936-1ER00		1	1 unit	41B
--		30 ... 250	5	3RT2936-1ES00		1	1 unit	41B	



3RT2936-1BF00

Size S3

For plugging into the two recesses on the left next to the connection block for auxiliary switches and coils A1 and A2. The connecting cables are wired to A1 and A2, see also page 3/11.

3RT2.4	RC elements	24 ... 48	24 ... 70	5	3RT2946-1CB00		1	1 unit	41B
		48 ... 127	70 ... 150	5	3RT2946-1CC00		1	1 unit	41B
		127 ... 240	150 ... 250	▶	3RT2946-1CD00		1	1 unit	41B
		240 ... 400	--	5	3RT2946-1CE00		1	1 unit	41B
		400 ... 600	--	5	3RT2946-1CF00		1	1 unit	41B



3RT2946-1C.00

¹⁾ Can be used for AC operation for 50/60 Hz. Other voltages on request.

²⁾ The varistor is already integrated on the AC/DC contactors.

³⁾ Surge suppressors 3RT2936-1B/-1E can be used for 3RT2.4 contactors as from product version E03.

Switching Devices – Contactors and Contactor Assemblies – for Switching Motors

Power Contactors for Switching Motors

Accessories for SIRIUS 3RT contactors and SIRIUS 3RH2 contactor relays > Surge suppressors

For contactors	Version	Rated control supply voltage $U_s^{1)}$		SD	Article No.	Price per PU	PU (UNIT, SET, M)	PS*	PG
		AC operation	DC operation						
Type		V AC	V DC	d					

Surge suppressors without LED

Sizes S6 to S12



3RT1956-1C.00

For connecting to withdrawable coil for contactors with

- Standard operating mechanisms 3RT1...-A...
- Solid-state operating mechanisms 3RT1...-N...

3RT1.5 ... 3RT1.7	RC elements	24 ... 48 48 ... 127 127 ... 240 240 ... 400 400 ... 600	24 ... 70 70 ... 150 150 ... 250 --	▶ ▶ ▶ ▶ ▶ 20

Screw terminals



Article No.	Price per PU	PU (UNIT, SET, M)	PS*	PG
3RT1956-1CB00		1	1 unit	41B
3RT1956-1CC00		1	1 unit	41B
3RT1956-1CD00		1	1 unit	41B
3RT1956-1CE00		1	1 unit	41B
3RT1956-1CF00		1	1 unit	41B



3RT1956-1C.02

3RT1.5 ... 3RT1.7	RC elements	24 ... 48 48 ... 127 127 ... 240 240 ... 400 400 ... 600	24 ... 70 70 ... 150 150 ... 250 --	▶ 2 ▶ 2 ▶ 20

Spring-loaded terminals



Article No.	Price per PU	PU (UNIT, SET, M)	PS*	PG
3RT1956-1CB02		1	1 unit	41B
3RT1956-1CC02		1	1 unit	41B
3RT1956-1CD02		1	1 unit	41B
3RT1956-1CE02		1	1 unit	41B
3RT1956-1CF02		1	1 unit	41B

1) Can be used for AC operation for 50/60 Hz. Other voltages on request.

For contactors	Version	Rated control supply voltage $U_s^{1)}$		Power consumption P of LED at U_s	SD	Article No.	Price per PU	PU (UNIT, SET, M)	PS*	PG
		AC operation	DC operation							
Type		V AC	V DC	mW	d					

Surge suppressors with LED (also for spring-loaded terminals)

Size S00



3RT2916-1J.00

For plugging onto the front of the contactors (with or without auxiliary switches)

3RT2.1, 3RH2	Varistors	24 ... 48 48 ... 127 127 ... 240 --	12 ... 24 24 ... 70 70 ... 150 150 ... 250	10 ... 120 20 ... 470 50 ... 700 160 ... 950	▶ ▶ ▶ 2

Article No.	Price per PU	PU (UNIT, SET, M)	PS*	PG
3RT2916-1JJ00		1	1 unit	41B
3RT2916-1JK00		1	1 unit	41B
3RT2916-1JL00		1	1 unit	41B
3RT2916-1JP00		1	1 unit	41B

3RT2.1, 3RH2	Noise suppression diodes	--	24 ... 70 50 ... 150 150 ... 250	20 ... 470 50 ... 700 160 ... 950	▶ 2 ▶

Article No.	Price per PU	PU (UNIT, SET, M)	PS*	PG
3RT2916-1LM00		1	1 unit	41B
3RT2916-1LN00		1	1 unit	41B
3RT2916-1LP00		1	1 unit	41B

Size S0



3RT2926-1MR00

For plugging into the front of the contactors (before mounting the auxiliary switch)

3RT2.2	Varistors	24 ... 48 48 ... 127 127 ... 240	12 ... 24 24 ... 70 70 ... 150	10 ... 120 20 ... 470 50 ... 700	▶ ▶ ▶

Article No.	Price per PU	PU (UNIT, SET, M)	PS*	PG
3RT2926-1JJ00		1	1 unit	41B
3RT2926-1JK00		1	1 unit	41B
3RT2926-1JL00		1	1 unit	41B

3RT2.2	Diode assemblies	--	24	20 ... 470	▶

Article No.	Price per PU	PU (UNIT, SET, M)	PS*	PG
3RT2926-1MR00		1	1 unit	41B

Sizes S2 and S3



3RT2936-1JJ00

For plugging into the front of the contactors (before mounting the auxiliary switch)

3RT2.3, 3RT2.4	Varistors ²⁾	24 ... 48 48 ... 127 127 ... 240	12 ... 24 24 ... 70 70 ... 150	10 ... 120 20 ... 470 50 ... 700	5 5 ▶

Article No.	Price per PU	PU (UNIT, SET, M)	PS*	PG
3RT2936-1JJ00		1	1 unit	41B
3RT2936-1JK00		1	1 unit	41B
3RT2936-1JL00		1	1 unit	41B

1) Can be used for AC operation for 50/60 Hz. Other voltages on request.

2) From product version E03 onwards, 3RT2936 surge suppressors can be used for 3RT2.4 contactors.

Switching Devices – Contactors and Contactor Assemblies – for Switching Motors

Power Contactors for Switching Motors

Accessories for SIRIUS 3RT contactors and SIRIUS 3RH2 contactor relays > Modules for contactor control

Selection and ordering data

For contactors	Version	SD	Article No.	Price per PU	PU (UNIT, SET, M)	PS*	PG
Type		d					

Coupling links for control by PLC

Screw terminals

Size S0



3RH2924-1GP11

For mounting onto the coil terminals of the contactors (for contactors with screw terminals only)

With LED for the switching state and with integrated varistor for damping opening surges

3RT2.2

- 24 V DC control, 17 ... 30 V DC operating range

▶

3RH2924-1GP11

1

1 unit

41B

Sizes S00 to S3

For mounting onto the front of contactors with AC, DC or AC/DC operation

- 24 V DC control, 17 ... 30 V DC operating range

3RT2.1,
3RT2.2,
3RT2.3,
3RT2.4
3RH2

5

3RH2914-1GP11

1

1 unit

41B



3RH2914-1GP11

Spring-loaded terminals

- 24 V DC control, 17 ... 30 V DC operating range

3RT2.1,
3RT2.2,
3RT2.3,
3RT2.4
3RH2

5

3RH2914-2GP11

1

1 unit

41B



3RH2914-2GP11

Technical specifications, [see page 3/84](#).

Switching Devices – Contactors and Contactor Assemblies – for Switching Motors

Power Contactors for Switching Motors

Accessories for SIRIUS 3RT contactors and SIRIUS 3RH2 contactor relays > Modules for contactor control

PU (UNIT, SET, M) = 1
 PS* = 1 unit
 PG = 41B

More information

Equipment Manual "SIRIUS – SIRIUS 3RA28 function modules for mounting on 3RT2 contactors", see <https://support.industry.siemens.com/cs/ww/en/view/60279150>





3RA2811-2CW10



3RA2812-1DW10



3RA2816-0EW20

For contactors	Size	Version	Rated control supply voltage U_s ¹⁾	Time setting range t	SD	Screw terminals 	SD	Spring-loaded terminals 	
Type			V AC/DC	s	d	Article No.	Price per PU	Article No.	Price per PU

3RA28 function modules for mounting onto 3RT2 contactors and 3RH2 contactor relays

For direct-on-line starting

3RT2.1 ²⁾ , 3RT2.2 ²⁾ , 3RH21 ²⁾ , 3RH24	S00, S0	ON-delay Two-wire design, varistor integrated	24 ... 240	0.05 ... 100 (1, 10, 100; selectable)	2	3RA2811-1CW10	2	3RA2811-2CW10
3RT2.3 ²⁾ , 3RT2.4 ²⁾³⁾	S2, S3	The electrical connection between the function module and the contactor underneath is established automatically when it is snapped on and locked.	24 ... 90 90 ... 240	0.05 ... 100 (1, 10, 100; selectable)	2 2	3RA2831-1DG10 3RA2831-1DH10	2 2	3RA2831-2DG10 3RA2831-2DH10
3RT2.1 ²⁾ , 3RT2.2 ²⁾ , 3RH21 ²⁾ , 3RH24	S00, S0	OFF-delay with control signal, varistor integrated	24 ... 240	0.05 ... 100 (1, 10, 100; selectable)	2	3RA2812-1DW10	2	3RA2812-2DW10
3RT2.3 ²⁾ , 3RT2.4 ²⁾³⁾	S2, S3	The electrical connection between the function module and the contactor underneath is established automatically when it is snapped on and locked.	24 ... 90 90 ... 240	0.05 ... 100 (1, 10, 100; selectable)	2 2	3RA2832-1DG10 3RA2832-1DH10	2 2	3RA2832-2DG10 3RA2832-2DH10

For star-delta (wye-delta) starting

3RT2.1, 3RT2.2, 3RT2.3 ²⁾ , 3RT2.4 ²⁾⁴⁾	S00 ... S3	Varistor integrated Comprising one basic module and two coupling modules The electrical connection between the function module and the contactor assembly is established automatically by snapping on and plugging in the connection cables.	24 ... 240	0.5 ... 60 (10, 30, 60; selectable)	2	3RA2816-0EW20	2	3RA2816-0EW20
--	------------	---	------------	---	---	----------------------	---	----------------------

Accessories

3RA28	S00 ... S3	Cover, sealable			2	3RA2910-0	2	3RA2910-0
-------	------------	------------------------	--	--	---	------------------	---	------------------

- 1) AC voltage values apply for 50 Hz and 60 Hz.
- 2) Cannot be fitted onto coupling relays and coupling contactor relays.
- 3) From product version E03 onwards, 3RA283. function modules can be used for 3RT2.4 contactors.
- 4) From product version E04 onwards, 3RA2816 function modules can be used for 3RT2.4 contactors.

Technical specifications, see page 3/85.

Assembly of reversing starters

We offer ready-made wiring kits for the assembly of reversing starters. Use of these wiring kits offers further advantages, see page 3/151.

Switching Devices – Contactors and Contactor Assemblies – for Switching Motors

Power Contactors for Switching Motors

Accessories for SIRIUS 3RT contactors and SIRIUS 3RH2 contactor relays > Modules for contactor control

PU (UNIT, SET, M) = 1
 PS* = 1 unit
 PG = 41B

More information

Equipment Manual "SIRIUS – 3RA2711 Function Modules for IO-Link", see <https://support.industry.siemens.com/cs/ww/en/view/39319600>

Equipment Manual "SIRIUS – 3RA2712 Function Modules for AS-Interface", see <https://support.industry.siemens.com/cs/ww/en/view/39318922>



3RA2711-1AA00

3RA2711-2AA00

3RA2711-1BA00

3RA2711-2BA00

3RA2712-1CA00

3RA2711-2CA00

For con- tactors	Size	Version	SD	Screw terminals	SD	Spring-loaded terminals
Type			d	Article No.	Price per PU	d Article No. Price per PU
SIRIUS 3RA27 function modules for direct-on-line starting						
3RT201	S00	IO-Link connection	2	3RA2711-1AA00	2	3RA2711-2AA00
...	...	Includes one module connector for creating an IO-Link group				
3RT204 ¹⁾	S3	AS-Interface connection	2	3RA2712-1AA00	2	3RA2712-2AA00
SIRIUS 3RA27 function modules for reversing starting²⁾						
3RT201	S00	IO-Link connection	2	3RA2711-1BA00	2	3RA2711-2BA00
...	...	Comprising one basic and one coupling module and an additional module connector ³⁾ for creating an IO-Link group				
3RT204 ¹⁾	S3	AS-Interface connection	2	3RA2712-1BA00	2	3RA2712-2BA00
		Comprising one basic and one coupling module				
		Assembly kits for making 3-pole contactor assemblies				
		See page 3/109				
SIRIUS 3RA27 function modules for star-delta (wye-delta) starting⁴⁾						
3RT201	S00	IO-Link connection	2	3RA2711-1CA00	2	3RA2711-2CA00
...	...	Comprising one basic and two coupling modules and an additional module connector ³⁾ for creating an IO-Link group				
3RT204 ¹⁾	S3	AS-Interface connection	2	3RA2712-1CA00	2	3RA2712-2CA00
		Comprising one basic and two coupling modules				
		Assembly kits for making 3-pole contactor assemblies				
		See page 3/110				

¹⁾ From product version E06 onwards, 3RA271. function modules can be used for 3RT2.4 contactors.

²⁾ For prewired reversing contactor assemblies with voltage tap-off, see pages 3/152 to 3/155. When these contactor assemblies are used, the assembly kit for the wiring is already integrated.

³⁾ 3RA2711-0EE17 module connectors for size S3 must be ordered separately, see page 3/107.

⁴⁾ For complete contactor assemblies for star-delta (wye-delta) starting including function modules, see pages 3/169 to 3/172.

For technical specifications for 3RA27 function modules, see page 3/86.

For contactors with voltage tap-off, see pages 3/60, 3/64, 3/68 and 3/69.

For IO-Link masters and AS-Interface masters, routers and power supply units, see "Industrial Communication", page 2/1 onwards.

Switching Devices – Contactors and Contactor Assemblies – for Switching Motors

Power Contactors for Switching Motors

Accessories for SIRIUS 3RT contactors and SIRIUS 3RH2 contactor relays > Modules for contactor control



3RA2711-0EE10



3RA2711-0EE06



3RA2711-0EE15



3RA2910-0



3RA6935-0A



3RA2711-0EE11

For function modules	Version	SD	Article No.	Price per PU	PU (UNIT, SET, M)	PS*	PG
Type		d					
Accessories for 3RA27 function modules							
3RA2711-...A00	Module connector set Comprising: • Two module connectors (14-pole, short) • Two interface covers	2	3RA2711-0EE10		1	1 unit	41B
3RA2711-...A00	Module connectors • 14-pole - 6 cm - 9 cm - 13 cm - 26 cm - 33.5 cm • 10-pole, 9 cm for the additional auxiliary voltage infeed <u>Note:</u> Selection of module connectors, see Equipment Manual "SIRIUS 3RA2711 Function Modules for IO-Link" .	2 2 2 2 2 2	3RA2711-0EE17 3RA2711-0EE06 3RA2711-0EE18 3RA2711-0EE07 3RA2711-0EE08 3RA2711-0EE16		1 1 1 1 1 1	1 unit 1 unit 1 unit 1 unit 1 unit 1 unit	41B 41B 41B 41B 41B 41B
3RA2711-...A00	Interface covers (Set of 5)	2	3RA2711-0EE15		1	1 unit	41B
3RA2711-...A00	Cover, sealable	2	3RA2910-0		1	5 units	41B
Operator panel for communication via IO-Link							
3RA2711-...A00	Operator panel (set) Comprising: • 1 x operator panel • 1 x enabling module • 1 x interface cover • 1 x fixing terminal	10	3RA6935-0A		1	1 unit	42F
3RA2711-...A00	Connection cable For connecting the operator panel to the coupling module Length 2 m, 10- to 14-pole	2	3RA2711-0EE11		1	1 unit	41B
3RA2711-...A00	Enabling modules (replacement)	10	3RA6936-0A		1	1 unit	42F
3RA2711-...A00	Interface covers (replacement)	10	3RA6936-0B		1	5 units	42F

Switching Devices – Contactors and Contactor Assemblies – for Switching Motors

Power Contactors for Switching Motors

Accessories for SIRIUS 3RT contactors and SIRIUS 3RH2 contactor relays > Modules for contactor control

For contactors	Rated control supply voltage U_s	Time setting range t	SD	Screw terminals 	PU (UNIT, SET, M)	PS*	PG
Type	V	s	d	Article No.	Price per PU		

Mechanical latching blocks (no switching state change in the event of voltage drop)

Size S0

For snapping onto the front of contactors

The contactor remains in the energized state after a power failure.



3RT2926-3A.31

3RT202,	24 AC/DC	--	▶	3RT2926-3AB31	1	1 unit	41B
3RT232,	110 AC/DC	--	5	3RT2926-3AF31	1	1 unit	41B
3RT252	230 AC/DC	--	5	3RT2926-3AP31	1	1 unit	41B

OFF-delay devices for contactors with AC/DC and DC operation

Sizes S00 to S3

Non-adjustable delay time



3RT2916-2B.01

3RT201.-1BF4., 3RT202.-1BF4., 3RT203.-1NF3., 3RH2...-1BF40	110 AC/DC	S00: > 0.1 S0: > 0.08 S2: > 0.25	5	3RT2916-2BK01	1	1 unit	41B
3RT201.-1BM4./1BP4., 3RT202.-1BM4./1BP4., 3RT203.-1NP3., 3RH2...-1BM40/1BP40	220/230 AC/DC	S00: > 0.5 S0: > 0.3 S2: > 0.8	5	3RT2916-2BL01	1	1 unit	41B
3RT201.-1BB4., 3RT202.-1BB4., 3RT203.-1NB3., 3RT204.-1NB3., 3RT244.-1NB3., 3RH2...-1BB40	24 DC	S00: > 0.2 S0: > 0.1 S2: > 0.1 S3: > 0.05	2	3RT2916-2BE01	1	1 unit	41B

Switching Devices – Contactors and Contactor Assemblies – for Switching Motors

Power Contactors for Switching Motors

Accessories for SIRIUS 3RT contactors and SIRIUS 3RH2 contactor relays > Link modules

Selection and ordering data

For contactors	Size	Version	SD	Article No.	Price per PU	PU (UNIT, SET, M)	PS*	PG
Type			d					

Safety main circuit connectors for two contactors



3RA2926-1A

3RT2.1	S00	For series connection of two contactors	2	3RA2916-1A		1	1 unit	41B
3RT2.2	S0		2	3RA2926-1A		1	1 unit	41B
3RT2.3	S2		2	3RA2936-1A		1	1 unit	41B

PU (UNIT, SET, M) = 1
 PS* = 1 unit (unless otherwise specified)
 PG = 41B

For contactors	Size	Version	SD	Article No.	Price per PU	SD	Article No.	Price per PU
Type			d			d		

Assembly kits for reversing contactor assemblies for making 3-pole contactor assemblies

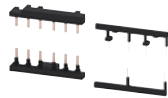

3RA2923-2AA1



3RA2923-2AA2



3RA2933-2AA1



3RA2943-2AA1



3RA2943-2AA2



3RA1953-2A



3RA1963-2A

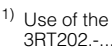

3RA1973-2A

For contactors	Size	Version	SD	Article No.	Price per PU	SD	Article No.	Price per PU
Type			d			d		
3RT201	S00-S00	The assembly kit contains: Mechanical interlock, two connecting clips for two contactors, wiring modules on the top and bottom • For main, auxiliary and control circuits ▶		3RA2913-2AA1			3RA2913-2AA2	
3RT202	S0-S0	The assembly kit contains: Mechanical interlock, two connecting clips for two contactors, wiring modules on the top and bottom • For main, auxiliary and control circuits ¹⁾ ▶ • Only for main circuit ²⁾		3RA2923-2AA1		--	3RA2923-2AA2	
3RT203	S2-S2	The assembly kit contains: Two connectors for two contactors, wiring modules on the top and bottom (3RA2934-2B mechanical interlock must be ordered separately, see page 3/113) • For main and auxiliary circuits ▶ • Only for main circuit ³⁾		3RA2933-2AA1		5	3RA2933-2AA2	
3RT204	S3-S3	The assembly kit contains: Two connectors for two contactors, wiring modules on the top and bottom (3RA2934-2B mechanical interlock must be ordered separately, see page 3/113) • For main and auxiliary circuits ▶ • Only for main circuit ³⁾	2	3RA2943-2AA1		2	3RA2943-2AA2	
3RT1.5	S6-S6	The assembly kit contains: Wiring modules on the top and bottom	2	3RA1953-2A		2	3RA1953-2A	
3RT1.6	S10-S10		2	3RA1963-2A		2	3RA1963-2A	
3RT1.7	S12-S12		2	3RA1973-2A		2	3RA1973-2A	

Screw terminals



Spring-loaded terminals



¹⁾ Use of the 3RA2923-2AA1 assembly kit in conjunction with the 3RT202.-.....-3MA0 contactors is limited because the auxiliary switches in the basic unit are not allowed to be used on account of the permanently mounted auxiliary switch.

²⁾ Version in size S0 with spring-loaded terminals:
Only the wiring modules for the main circuit are included.
No connecting clips are included for the auxiliary and control circuit.

³⁾ Version in sizes S2 and S3 with spring-loaded terminals in the auxiliary and control circuits: Only the wiring modules for the main circuit are included.
A cable set is included for the auxiliary circuit.

Switching Devices – Contactors and Contactor Assemblies – for Switching Motors

Power Contactors for Switching Motors

Accessories for SIRIUS 3RT contactors and SIRIUS 3RH2 contactor relays > Link modules

PU (UNIT, SET, M) = 1
 PS* = 1 unit (unless otherwise specified)
 PG = 41B

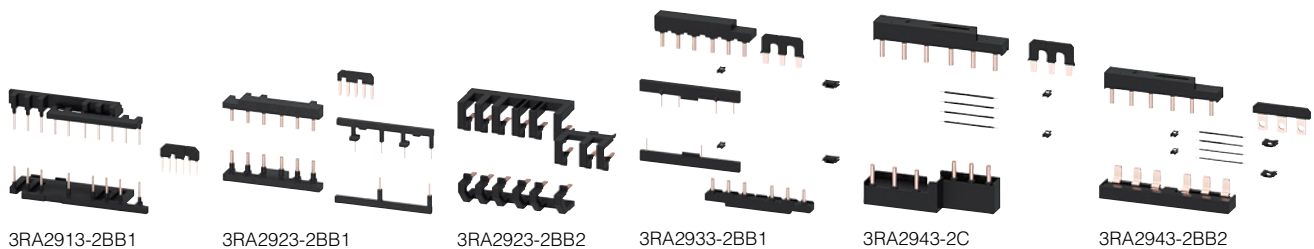

For con- tactors	Size	Version	SD	Screw terminals		Spring-loaded terminals	
				Article No.	Price per PU	Article No.	Price per PU
Type				d	d	d	d
Assembly kits¹⁾ for contactor assemblies for star-delta (wye-delta) starting for making 3-pole contactor assemblies							
3RT01	S00-S00-S00	The assembly kit contains: Mechanical interlock, four connecting clips for three contactors, a star jumper, wiring modules on the top and bottom <ul style="list-style-type: none"> For main, auxiliary and control circuits 		▶ 3RA2913-2BB1		▶ 3RA2913-2BB2	
3RT02	S0-S0-S0	The assembly kit contains: Mechanical interlock, four connecting clips for three contactors, a star jumper, wiring modules on the top and bottom <ul style="list-style-type: none"> For main, auxiliary and control circuits Only for main circuit 		▶ 3RA2923-2BB1		▶ 3RA2923-2BB2	
3RT02	S0-S0-S0	The assembly kit contains: Mechanical interlock, four connecting clips for three contactors, a star jumper, wiring modules on the top and bottom, three-phase infeed terminal <ul style="list-style-type: none"> For main, auxiliary and control circuits 	5	▶ 3RA2924-2BB1		▶ 3RA2923-2BB2	
3RT03	S2-S2-S0	The assembly kit ²⁾ contains: Two connectors for three contactors, an S0 star jumper, a spacer, wiring modules on the top and bottom (S2-S0) for the main circuit, a cable set for the auxiliary circuit, a cable for connecting the A2 coil contact of the line contactor to the A2 coil contact of the delta contactor		▶ 3RA2933-2C		▶ 3RA2933-2C	
3RT03	S2-S2-S2	The assembly kit ²⁾ contains: Four connectors for three contactors, an S2 star jumper, a cable for connecting the A2 coil contact of the line contactor to the A2 coil contact of the delta contactor and <ul style="list-style-type: none"> Wiring modules on the top and bottom for the main circuit and the auxiliary circuit Wiring modules on the top and bottom for the main circuit, a cable set for the auxiliary circuit 		▶ 3RA2933-2BB1		▶ 3RA2933-2BB2	
3RT04	S3-S3-S2	The assembly kit ²⁾ contains: Two connectors for three contactors, an S2 star jumper, a spacer, wiring modules on the top and bottom (S3-S2) for the main circuit, a cable set for the auxiliary circuit, a cable for connecting the A2 coil contact of the line contactor to the A2 coil contact of the delta contactor	2	▶ 3RA2943-2C		▶ 3RA2943-2C	
3RT04	S3-S3-S3	The assembly kit ²⁾ contains: Four connectors for three contactors, an S3 star jumper, a cable for connecting the A2 coil contact of the line contactor to the A2 coil contact of the delta contactor and <ul style="list-style-type: none"> Wiring modules on the top and bottom for the main circuit and the auxiliary circuit Wiring modules on the top and bottom for the main circuit, a cable set for the auxiliary circuit 	2	▶ 3RA2943-2BB1		▶ 3RA2943-2BB2	

¹⁾ When using the function modules for contactor assemblies for star-delta (wye-delta) starting, the wiring modules for the auxiliary current are not required.

²⁾ The 3RA2934-2B mechanical interlock for sizes S2 and S3 must be ordered separately, see page 3/113.

Switching Devices – Contactors and Contactor Assemblies – for Switching Motors

Power Contactors for Switching Motors

Accessories for SIRIUS 3RT contactors and SIRIUS 3RH2 contactor relays > Link modules

For contactors	Size	Version	SD	Article No.	Price per PU	PU (UNIT, SET, M)	PS*	PG
----------------	------	---------	----	-------------	--------------	-------------------	-----	----

Type

d

Assembly kits for contactor assemblies for star-delta (wye-delta) starting for making 3-pole contactor assemblies













				The assembly kit contains: link rails at bottom (a double infeed between the line contactor and the delta contactor is recommended.)				
 3RA1953-3G	3RT1.5, 3RT204	S6-S6-S3 For connection with box terminal	The S3 star jumper must be ordered separately, see page 3/112.	20	3RA1953-3G	1	1 unit	41B
	 3RA1953-2B	3RT1.5	S6-S6-S6 For connection with box terminal	--	2	3RA1953-2B	1	1 unit
 3RA1953-2N	3RT1.5	S6-S6-S6 For connection without box terminal	--	2	3RA1953-2N	1	1 unit	41B
	 3RA1963-3E	3RT1.6, 3RT1.5	S10-S10-S6 For connection with box terminal	The S6 star jumper must be ordered separately, see page 3/112.	20	3RA1963-3E	1	1 unit
 3RA1963-2B	3RT1.6	S10-S10-S10 For connection without box terminal	--	2	3RA1963-2B	1	1 unit	41B
	 3RA1973-3E	3RT1.7, 3RT1.6	S12-S12-S10 For connection with box terminal	The S10 star jumper must be ordered separately, see page 3/112.	20	3RA1973-3E	1	1 unit
 3RA1973-2B	3RT1.7	S12-S12-S12 For connection without box terminal	--	5	3RA1973-2B	1	1 unit	41B

Switching Devices – Contactors and Contactor Assemblies – for Switching Motors

Power Contactors for Switching Motors

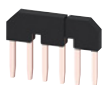
Accessories for SIRIUS 3RT contactors and SIRIUS 3RH2 contactor relays > Link modules

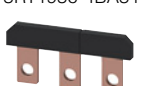
PU (UNIT, SET, M) = 1
 PS* = 1 unit (unless otherwise specified)
 PG = 41B

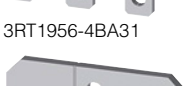
For con- tactors Type	Size	Version	SD	Article No.	Price per PU	SD	Article No.	Price per PU
Single wiring modules for making 3-pole contactor assemblies								
				Screw terminals 		Spring-loaded terminals 		
 3RA2913-3DA1	3RT201	S00-S00	• Top (in-phase) PS = 5 units • Bottom (with phase reversal) PS = 5 units	▶	3RA2913-3DA1	5	3RA2913-3DA2	
 3RA2913-3DA2	3RT202	S0-S0	• Top (in-phase) PS = 5 units • Bottom (with phase reversal) PS = 5 units	▶	3RA2923-3DA1	5	3RA2923-3DA2	
 3RA1933-3D	3RT203	S2-S2	• Top (in-phase), contactor clearance 10 mm • Bottom (with phase reversal), contactor clearance 10 mm	▶	3RA1933-3D	2	3RA1933-3D	
 3RA1943-3E	3RT204	S3-S3	• Top (in-phase), contactor clearance 10 mm • Bottom (with phase reversal), contactor clearance 10 mm	▶	3RA1943-3D	5	3RA1943-3D	
 3RA1953-3D	3RT1.5	S6-S6	• Top (in-phase, for connection with box terminal), contactor clearance 10 mm • Top (with phase reversal, for connection without box terminal), contactor clearance 10 mm	▶	3RA1953-3D	2	3RA1953-3D	
				▶	3RA1953-3P	5	3RA1953-3P	
Star jumpers (links for paralleling), 3-pole								
				Screw terminals 		Spring-loaded terminals 		
 3RT1916-4BA31	3RT201	S00	With through-hole The links for paralleling can be reduced by one pole. Without connecting terminal	▶	3RT1916-4BA31	2	3RT2916-4BA32	
 3RT2926-4BA32	3RT202	S0		▶	3RT1926-4BA31	2	3RT2926-4BA32	
 3RT1936-4BA31	3RT203	S2		▶	3RT1936-4BA31	▶	3RT1936-4BA31	
 3RT1946-4BA31	3RT204	S3		▶	3RT1946-4BA31	▶	3RT1946-4BA31	
 3RT1956-4BA31	3RT1.5	S6		▶	3RT1956-4BA31	2	3RT1956-4BA31	
 3RT1966-4BA31	3RT1.6, 3RT1.7	S10, S12		▶	3RT1966-4BA31	2	3RT1966-4BA31	

Switching Devices – Contactors and Contactor Assemblies – for Switching Motors

Power Contactors for Switching Motors

Accessories for SIRIUS 3RT contactors and SIRIUS 3RH2 contactor relays > Link modules



For contactors	Size	Version	SD	Article No.	Price per PU	PU (UNIT, SET, M)	PS*	PG
Type			d					

Mechanical interlock assembly kits for two contactors for making 3- and 4-pole contactor assemblies



 3RA29.2-2H	3RT201, 3RT231	S00-S00	The interlocking assembly kits can be used without a contactor clearance.	▶	3RA2912-2H	1	10 units	41B
	3RT202, 3RT232	S0-S0	One assembly kit consists of a mechanical interlock and two connecting clips.	▶	3RA2922-2H	1	10 units	41B

For contactors	Size	Version	SD	Article No.	Price per PU	PU (UNIT, SET, M)	PS*	PG
Type			d					

Mechanical interlocks for contactor assemblies

 3RA2934-2B	3RT202, 3RT203, 3RT204	S2-S2-S0, S2-S2-S2, S3-S3-S2, S3-S3-S3	Mechanical interlocks Note: The mechanical interlock for sizes S2 and S3 must be ordered separately.	▶	3RA2934-2B	1	1 unit	41B
	3RT1.5 with 3RT204 ¹⁾	S6 (3RT1)-S6 (3RT1)-S3 (3RT2)¹⁾	Adapter in addition to the mechanical interlock The mechanical interlock is only possible together with this 3RA1954-2G adapter and the 3RA1954-2A mechanical interlock. Two connectors are included with the adapter, the interlock must be ordered separately.	▶	3RA1954-2G	1	1 unit	41B
 3RA1954-2A	3RT1.5, 3RT1.6, 3RT1.7	S6, S10, S12	Mechanical interlocks Without auxiliary contacts; contactors in sizes S6, S10 and S12 can be interlocked with each other as required. No adaption of mounting depth is necessary.	▶	3RA1954-2A	1	1 unit	41B

Mechanical connectors for contactor assemblies

 3RA1932-2D	3RT203, 3RT204	S2-S2, S3-S3	Two connectors are required for each assembly. The contactor clearance must be considered when selecting the connectors.					
			3-pole version					
	3RT105	S6-S6	<ul style="list-style-type: none"> Without contactor clearance With 10 mm contactor clearance 	▶	3RA2932-2C	1	10 units	41B
			<ul style="list-style-type: none"> With 10 mm contactor clearance (1 unit corresponds to 2 parts for 1 assembly)	▶	3RA2932-2D	1	10 units	41B
			4-pole version					
 3RA2942-2G	3RT233	S2-S2	<ul style="list-style-type: none"> With 20 mm contactor clearance 	▶	3RA1932-2D	1	10 units	41B
	3RT234.	S3-S3	<ul style="list-style-type: none"> With 10 mm contactor clearance 	▶	3RA2932-2G	1	10 units	41B





¹⁾ The 3RA1954-2G adapter cannot be used in conjunction with 3RT204.-.KB coupling contactors, size S3.

Switching Devices – Contactors and Contactor Assemblies – for Switching Motors

Power Contactors for Switching Motors

Accessories for SIRIUS 3RT contactors and SIRIUS 3RH2 contactor relays > Terminal modules/adapters

Selection and ordering data

For con- tactors	Size	Version	SD	Screw terminals	⊕	PU (UNIT, SET, M)	PS*	PG
Type			d	Article No.	Price per PU			
Links for paralleling for main circuits								
The links for paralleling (insulated) can be reduced by one pole. With connecting terminal								
3-pole								
	3RT201	S00	• Max. conductor cross-section: 25 mm ² , stranded ▶	3RT1916-4BB31	1	1 unit	41B	
3RT1916-4BB31								
	3RT202	S0	• Max. conductor cross-section: 50 mm ² , stranded	3RT2926-4BB31	1	1 unit	41B	
3RT2926-4BB31								
	3RT203	S2	• Max. conductor cross-section: 120 mm ² , stranded ▶	3RT1936-4BB31	1	1 unit	41B	
3RT1936-4BB31								
	3RT204, 3RT244	S3	• Max. conductor cross-section: 185 mm ² , stranded A cover plate is included for touch protection (can only be used when box terminal is removed).	3RT1946-4BB31	1	1 unit	41B	
3RT1946-4BB31								
4-pole								
	3RT231, 3RT251	S00	• Max. conductor cross-section: 25 mm ² , stranded	3RT1916-4BB41	1	1 unit	41B	
3RT1916-4BB41								

Switching Devices – Contactors and Contactor Assemblies – for Switching Motors

Power Contactors for Switching Motors

Accessories for SIRIUS 3RT contactors and SIRIUS 3RH2 contactor relays > Terminal modules/adapters

For con- tactors	Size	Version	SD	Article No.	Price per PU	PU (UNIT, SET, M)	PS*	PG
Type			d					
Single-phase infeed terminals								
	3RT204, 3RT244, 3RT264	S3	Conductor cross-section: 95 mm ²	2	3RA2943-3L		1	1 unit 41B
3RA2943-3L								
Three-phase infeed terminals								
Infeed terminal blocks for the line contactor for large conductor cross-sections								
	3RT201	S00	Max. conductor cross-section: up to 10 mm ² , AWG 12 ... 8	2	3RA2913-3K		1	10 units 41B
3RA2913-3K								
	3RT202	S0	Max. conductor cross-section: up to 25 mm ² , AWG 10 ... 2/0	▶	3RV2925-5AB		1	1 unit 41E
3RV2925-5AB								
	3RT203	S2	Max. conductor cross-section: up to 70 mm ² , AWG 10 ... 2/0	▶	3RV2935-5A		1	1 unit 41E
3RV2935-5A								
Three-phase infeed terminals with increased clearances and creepage distances								
	3RT203	S2	Max. conductor cross-section: up to 70 mm ² , AWG 10 ... 2/0	▶	3RV2935-5E		1	1 unit 41E
3RV2935-5E								
Three-phase busbars								
	3RT202	S0	Bridging phase-by-phase of all input terminals of the line contactor (Q11) and delta contactor (Q13)	▶	3RV1915-1AB		1	1 unit 41E
3RV1915-1AB								
Terminal blocks for connecting auxiliary conductors to main terminals								
Box terminal blocks								
For round and ribbon cables Connectable cross-sections of the contactors, see Technical specifications, page 3/51 .								
	3RT204	S3	• 3-pole, for connection of main contacts, NEW X 2.5 to 70 mm		3RT2946-4G		1	1 unit 41B
3RT1956-4G								
	3RT1.5	S6	• Up to 70 mm ² , as standard on 3RT1054-1 contactor (55 kW)	▶	3RT1955-4G		1	1 unit 41B
3RT1956-4G								
	3RT1.6, 3RT1.7	S10, S12	• Up to 240 mm ² , with auxiliary conductor connection up to 2.5 mm ²	▶	3RT1966-4G		1	1 unit 41B
3RT1966-4G								
	3RT1.5	S6	Box terminal for auxiliary conductor connection, 1-pole For connection of auxiliary and control cables (0.5 ... 2.5 mm ²) to the main conductor terminals	5	3TX7500-0A		1	1 unit 41B
3TX7500-0A								
	3RT204	S3	Auxiliary terminals, 3-pole For connection of auxiliary and control cables (0.5 ... 2.5 mm ²) to the main conductor terminals	5	3RT2946-4F		1	1 unit 41B
3RT2946-4F								

Switching Devices – Contactors and Contactor Assemblies – for Switching Motors

Power Contactors for Switching Motors

Accessories for SIRIUS 3RT contactors and SIRIUS 3RH2 contactor relays > Terminal modules/adapters















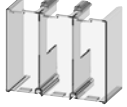

For contactors	Size	Version	SD	Article No.	Price per PU	PU (UNIT, SET, M)	PS*	PG
Type			d					
Solder pin adapters for mounting contactors onto printed circuit boards up to 5.5 kW / 12 A								
 3RT2.1, 3RH21	S00	Assembly kit for soldering contactors with an integrated auxiliary contact onto a printed circuit board <u>Note:</u> For 1 contactor, 1 set is required.	2	Screw terminals 		1	4 units	41B
				3RT1916-4KA1				
 3RT1916-4KA1	S00	Assembly kit for soldering contactors with 4-pole mounted auxiliary switch onto a printed circuit board <u>Note:</u> For 1 contactor, 1 set is required.	5	Screw terminals 		1	4 units	41B
				3RT1916-4KA2				
 3RT1916-4KA2	S00	Assembly kit for soldering contactors with 4-pole mounted auxiliary switch onto a printed circuit board <u>Note:</u> For 1 contactor, 1 set is required.	5	Screw terminals 		1	4 units	41B
				3RT1916-4KA2				
Coil connection modules for connections from top or from below								
 3RT2926-4RA11	S0 to S3	<ul style="list-style-type: none"> • Connection from top • Connection from below • Connection diagonally 	2	Screw terminals 		1	1 unit	41B
			5	Screw terminals 		1	1 unit	41B
			5	Screw terminals 		1	1 unit	41B
 3RT2926-4RA12	S0	<ul style="list-style-type: none"> • Connection from top • Connection from below 	5	Spring-loaded terminals 		1	1 unit	41B
			5	Spring-loaded terminals 		1	1 unit	41B
Connection module (adapter and plug) for contactors with screw terminals								
 3RT1926-4RD01	S00	The connection module comprises an adapter and a motor feeder connector. Adapters Ambient temperature $t_{u \max} = 60 \text{ °C}$ <ul style="list-style-type: none"> • Rated operational current I_{θ} at AC-3/400 V: 20 A 	5	Screw terminals 		1	1 unit	41B
			5	Screw terminals 		1	1 unit	41B
			5	Screw terminals 		1	1 unit	41B
 3RT1900-4RE01	S00, S0	Motor feeder connector	5	Screw terminals 		1	1 unit	41B
			5	Screw terminals 		1	1 unit	41B

Switching Devices – Contactors and Contactor Assemblies – for Switching Motors

Power Contactors for Switching Motors

Accessories for SIRIUS 3RT contactors and SIRIUS 3RH2 contactor relays > Covers

Selection and ordering data

For contactors	Size	Version	SD	Article No.	Price per PU	PU (UNIT, SET, M)	PS*	PG
Type			d					
Terminal covers								
Covers for contactors with screw terminals (box terminals) (2 units required per contactor)								
		3RT203 3RT204, 3RT244	S2 S3	• For 3-pole contactors	▶ 3RT2936-4EA2 ▶ 3RT2946-4EA2	1 1	1 unit 1 unit	41B 41B
		3RT1.5 3RT1.6, 3RT1.7	S6¹⁾ S10¹⁾, S12¹⁾		▶ 3RT1956-4EA2 ▶ 3RT1966-4EA2	1 1	1 unit 1 unit	41B 41B
		3RT233, 3RT253 3RT234, 3RT254	S2 S3	• For 4-pole contactors (Scope of supply: one 3-pole and two 1-pole terminal covers are supplied)	▶ 3RT2936-4EA4 ▶ 3RT2946-4EA4	1 1	1 unit 1 unit	41B 41B
Covers for contactors with cable lugs and busbar connections								
For complying with the phase clearances and as touch protection if box terminal is removed (2 units required per contactor)								
		3RT2.4 3RT1.5 3RT1.6, 3RT1.7	S3 S6¹⁾ S10¹⁾, S12¹⁾	• Length: 100 mm • Length: 100 mm • Length: 120 mm	▶ 3RT1946-4EA1 ▶ 3RT1956-4EA1 ▶ 3RT1966-4EA1	1 1 1	1 unit 1 unit 1 unit	41B 41B 41B
								
		3RT1.5	S6	• For the assembly kits for 3RA1953-... contactor assemblies for star-delta (wye-delta) starting (page 3/111) or for the 3RA1953-3 single wiring modules. (page 3/112) - Length: 38 mm	▶ 3RT1956-4EA4	1	1 unit	41B
Terminal covers for busbar connections								
• Cover the three busbar connections, between the contactor and 3RB2 overload relay								
		3RT1.5 3RT1.6, 3RT1.7	S6 S10²⁾, S12²⁾	- Length: 27 mm - Length: 42 mm	▶ 3RT1956-4EA3 ▶ 3RT1966-4EA3	1 1	1 unit 1 unit	41B 41B
		3RT1.5 3RT1.6, 3RT1.7	S6 S10, S12	• Can be screwed on free screw end; cover one busbar connection (1 set = 6 units) - M8 - M10	▶ 3TX6526-3B ▶ 3TX6546-3B	1 1	1 unit 1 unit	41B 41B
Sealable covers								
		3RT2.1, 3RT2.2, 3RT2.3, 3RT2.4, 3RH2 ³⁾ 3RT1.5 ... 3RT1.7 ³⁾	S00 ... S3 S6 ... S12	For preventing manual operation (Not suitable for coupling relays)	▶ 3RT2916-4MA10 ▶ 3RT1926-4MA10	1 1	5 units 5 units	41B 41B

¹⁾ Also fits on contactors of sizes S6 to S12 with box terminals.

²⁾ The 3RT1966-4EA3 cover is required in addition for use in reversing contactor assemblies and contactor assemblies for star-delta (wye-delta) starting.

³⁾ Exception: Contactors and contactor relays with auxiliary switch mounted onto the front.

Switching Devices – Contactors and Contactor Assemblies – for Switching Motors

Power Contactors for Switching Motors

Accessories for SIRIUS 3RT contactors and SIRIUS 3RH2 contactor relays > Miscellaneous accessories

Selection and ordering data

For contactors	Size	Version	SD	Article No.	Price per PU	PU (UNIT, SET, M)	PS*	PG
Base plates								
For reversing contactor assemblies								
	3RT1.5	S6	For customer assembly of reversing contactor assemblies	5	3RA1952-2A		1	1 unit 41B
	3RT1.6	S10		5	3RA1962-2A		1	1 unit 41B
	3RT1.7	S12		5	3RA1972-2A		1	1 unit 41B
For contactor assemblies for star-delta (wye-delta) starting								
	3RT2/ 3RT2/ 3RT2	S2-S2-S0, S2-S2-S2 S3-S3-S2, S3-S3-S3	For configuring contactor assemblies for star-delta (wye-delta) starting	2	3RA2932-2F		1	1 unit 41B
				3	3RA2942-2F		1	1 unit 41B
	3RT1/ 3RT1/ 3RT2	S6-S6-S3	For customer assembly of contactor assemblies for star-delta (wye-delta) starting with a laterally mounted timing relay	5	3RA1952-2E		1	1 unit 41B
	3RT1/ 3RT1/ 3RT1	S6-S6-S6 S10-S10-S6 S10-S10-S10 S12-S12-S10 S12-S12-S12	10 mm distance between the contactors	5	3RA1952-2F		1	1 unit 41B
				5	3RA1962-2E		1	1 unit 41B
				5	3RA1962-2F		1	1 unit 41B
				5	3RA1972-2E		1	1 unit 41B
				5	3RA1972-2F		1	1 unit 41B
Adapters for screw fixing								
	3RT2.2	S0	Screw adapters for securing the contactors, two units required per contactor (1 pack = 10 sets for 10 contactors)	15	3RT1926-4P		1	10 units 41B
Connection kit for one complete contactor NEW								
	3RT105	S6	Each set includes 6 screws, spring washers and nuts. M 8 x 25	5	3RT1955-4PA00		1	1 unit 41B
	3RT106, 3RT107	S10, S12	M 10 x 30	5	3RT1966-4PA00		1	1 unit 41B
EMC suppression modules; three-phase, up to 7.5 kW								
For contactors with AC or DC operation								
	3RT201	S00	RC elements (3 x 220 Ω/0.22 μF) • Up to 400 V • Up to 575 V • Up to 690 V	2 2 2	3RT2916-1PA1 3RT2916-1PA2 3RT2916-1PA3		1	1 unit 41B 1 unit 41B 1 unit 41B
	3RT201	S00	Varistors • Up to 400 V • Up to 575 V • Up to 690 V	2 2 15	3RT2916-1PB1 3RT2916-1PB2 3RT2916-1PB3		1	1 unit 41B 1 unit 41B 1 unit 41B



3RA1952-2A



3RA2932-2F



3RA2942-2F



3RA1952-2E



3RA1952-2F



3RT1926-4P



3RT1955-4PA00



3RT2916-1PA



Screw terminals



Switching Devices – Contactors and Contactor Assemblies – for Switching Motors

Power Contactors for Switching Motors





Accessories for SIRIUS 3RT contactors and SIRIUS 3RH2 contactor relays > Miscellaneous accessories

	For contactors	Size	Version	SD	Article No.	Price per PU	PU (UNIT, SET, M)	PS*	PG	
Additional load modules										
 3RT2916-1GA00	3RT2.1, 3RH2	S00	<p>For plugging onto the front of the contactors with or without auxiliary switches</p> <p>For increasing the permissible residual current and for limiting the residual voltage, it ensures the safe opening of contactors with direct control via 230 V AC semiconductor outputs of SIMATIC controllers, simultaneously provides overvoltage damping</p> <p>Rated voltage: 50/60 Hz AC, 180 ... 255 V Operating range: 0.8 ... 1.1 x U_s</p>	▶	3RT2916-1GA00		1	1 unit	41B	
	LED modules for displaying contactor operation									
 3RT2926-1QT00	3RT2, 3RT1	S00 ... S12	<p>For snapping into the location hole of 5 an inscription label on the front of a contactor either directly on the contactor or on the front auxiliary switch.</p> <p>The LED module is connected to coil terminals A1 and A2 of the contactor and indicates its energized state with a yellow LED. Connecting leads need to be extended as required.</p> <p>Rated voltage: 24 ... 240 V AC/DC with reverse polarity protection</p>	5	3RT2926-1QT00		1	5 units	41B	
	Control kit									
 3RT2916-4MC00	3RT2.1, 3RH2	S00	For manual operation of contactor contacts, for startup and service	2	3RT2916-4MC00		1	5 units	41B	
	3RT2.2	S0			2	3RT2926-4MC00		1	5 units	41B
	3RT2.3, 3RT2.4	S2, S3			2	3RT2936-4MC00		1	5 units	41B

Switching Devices – Contactors and Contactor Assemblies – for Switching Motors

Power Contactors for Switching Motors

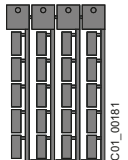
Accessories for SIRIUS 3RT contactors and SIRIUS 3RH2 contactor relays > Miscellaneous accessories

For contactors	Size	Version	SD	Article No.	Price per PU	PU (UNIT, SET, M)	PS*	PG
Type			d					
Insulation stop for securely holding back the conductor insulation for conductors up to 1 mm²								
 <p>Insulation stop strip Can be inserted in cable entry of the spring-loaded terminal (two strips per contactor required)</p>				 <p>Spring-loaded terminals</p>				
3RT2916-4JA02	3RT2.1, 3RH2	S00	5	3RT2916-4JA02		1	20 units	41B
3RT1916-4JA02	3RT2.2 ... 3RT2.4, 3RT1, 3RH29	S0 ... S12	5	3RT1916-4JA02		1	20 units	41B
Tools for opening spring-loaded terminals								
 <p>Screwdrivers For all SIRIUS devices with spring-loaded terminals Length: approx. 200 mm, 3.0 mm x 0.5 mm, titanium gray/black, partially insulated</p>								
3RA2908-1A	3RT, 3RH	S00 ... S12	2	3RA2908-1A		1	1 unit	41B
Blank labels								
 <p>Unit labeling plates For SIRIUS devices¹⁾</p>								
	3RT	S00 ... S12	20	3RT2900-1SB10		100	816 units	41B
			20	3RT2900-1SB20		100	340 units	41B
 <p>Adhesive labels For SIRIUS devices</p>								
3RT2900-1SB20	3RT	S00 ... S12	5	3RT2900-1SB60		100	3 060 units	41B

¹⁾ PC labeling system for individual inscription of unit labeling plates available from: murrplastik Systemtechnik GmbH (see page 16/15).

Switching Devices – Contactors and Contactor Assemblies – for Switching Motors

Power Contactors for Switching Motors

Spare parts for SIRIUS 3RT contactors and SIRIUS 3RH2 contactor relays > Solenoid coils

Selection and ordering data

Screw terminals and spring-loaded terminals

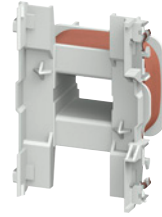

3RT2924-5A.01

For contactors	Rated control supply voltage U_s			SD	Article No.	Price per PU	PU (UNIT, SET, M)	PS*	PG
	50 Hz	50/60 Hz	60 Hz						
Type	V	V	V	d					
Solenoid coils · AC operation									
Size S0									
3RT2023-A,	24	--	--	5	3RT2924-5AB01		1	1 unit	41B
3RT2024-A,	42	--	--	5	3RT2924-5AD01		1	1 unit	41B
3RT2025-A	48	--	--	5	3RT2924-5AH01		1	1 unit	41B
	110	--	--	5	3RT2924-5AF01		1	1 unit	41B
	230	--	--	5	3RT2924-5AP01		1	1 unit	41B
	400	--	--	5	3RT2924-5AV01		1	1 unit	41B
	--	24	--	5	3RT2924-5AC21		1	1 unit	41B
	--	42	--	5	3RT2924-5AD21		1	1 unit	41B
	--	48	--	5	3RT2924-5AH21		1	1 unit	41B
	--	110	--	5	3RT2924-5AG21		1	1 unit	41B
	--	220	--	5	3RT2924-5AN21		1	1 unit	41B
	--	230	--	5	3RT2924-5AL21		1	1 unit	41B
	--	--	24	X	3RT2924-5AC11		1	1 unit	41B
	110	--	120	5	3RT2924-5AK61		1	1 unit	41B
	220	--	240	5	3RT2924-5AP61		1	1 unit	41B
	--	100	110	5	3RT2924-5AG61		1	1 unit	41B
	--	200	220	5	3RT2924-5AN61		1	1 unit	41B
	--	400	440	5	3RT2924-5AR61		1	1 unit	41B
3RT2026-A,	24	--	--	5	3RT2926-5AB01		1	1 unit	41B
3RT2027-A,	42	--	--	5	3RT2926-5AD01		1	1 unit	41B
3RT2028-A	48	--	--	5	3RT2926-5AH01		1	1 unit	41B
3RT2325-A,	110	--	--	5	3RT2926-5AF01		1	1 unit	41B
3RT2326-A,	230	--	--	5	3RT2926-5AP01		1	1 unit	41B
3RT2327-A	400	--	--	5	3RT2926-5AV01		1	1 unit	41B
3RT2526-A	--	24	--	5	3RT2926-5AC21		1	1 unit	41B
	--	42	--	X	3RT2926-5AD21		1	1 unit	41B
	--	48	--	5	3RT2926-5AH21		1	1 unit	41B
	--	110	--	5	3RT2926-5AG21		1	1 unit	41B
	--	220	--	5	3RT2926-5AN21		1	1 unit	41B
	--	230	--	5	3RT2926-5AL21		1	1 unit	41B
	--	--	24	5	3RT2926-5AC11		1	1 unit	41B
	110	--	120	5	3RT2926-5AK61		1	1 unit	41B
	220	--	240	5	3RT2926-5AP61		1	1 unit	41B
	--	100	110	X	3RT2926-5AG61		1	1 unit	41B
	--	200	220	5	3RT2926-5AN61		1	1 unit	41B
	--	400	440	5	3RT2926-5AR61		1	1 unit	41B

Note:

Contactors with AC and AC/DC coils have different depths. It is only possible to replace the coils on AC contactors with AC coils. It is not possible to replace the coils on DC contactors.

Switching Devices – Contactors and Contactor Assemblies – for Switching Motors

Power Contactors for Switching Motors

Spare parts for SIRIUS 3RT contactors and SIRIUS 3RH2 contactor relays > Solenoid coils

Screw terminals and spring-loaded terminals

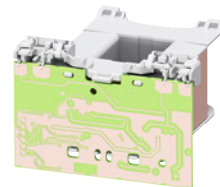
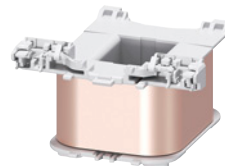
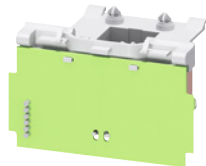
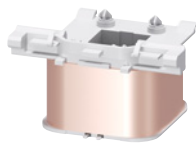

3RT2934-5A.01

3RT2934-5N.31

3RT2944-5A..1

3RT2944-5N.31

For contactors	Rated control supply voltage U_s				SD	Article No.	Price per PU	PU (UNIT, SET, M)	PS*	PG
	50 Hz	50/60 Hz	60 Hz	DC						
Type	V	V	V		d					

Solenoid coils · AC operation

Size S2

3RT203.-A,	24	--	--	--	5	3RT2934-5AB01		1	1 unit	41B
3RT233.-A,	42	--	--	--	5	3RT2934-5AD01		1	1 unit	41B
3RT243.-A,	48	--	--	--	5	3RT2934-5AH01		1	1 unit	41B
3RT253.-A	110	--	--	--	5	3RT2934-5AF01		1	1 unit	41B
	230	--	--	--	5	3RT2934-5AP01		1	1 unit	41B
	400	--	--	--	5	3RT2934-5AV01		1	1 unit	41B
	--	24	--	--	5	3RT2934-5AC21		1	1 unit	41B
		42	--	--	X	3RT2934-5AD21		1	1 unit	41B
		48	--	--	5	3RT2934-5AH21		1	1 unit	41B
		110	--	--	5	3RT2934-5AG21		1	1 unit	41B
		208	--	--	5	3RT2934-5AM21		1	1 unit	41B
		220	--	--	5	3RT2934-5AN21		1	1 unit	41B
		230	--	--	5	3RT2934-5AL21		1	1 unit	41B
	110	--	120	--	5	3RT2934-5AK61		1	1 unit	41B
	220	--	240	--	5	3RT2934-5AP61		1	1 unit	41B
	--	--	480	--	5	3RT2934-5AV61		1	1 unit	41B
	--	--	600	--	5	3RT2934-5AT61		1	1 unit	41B
	--	100	110	--	X	3RT2934-5AG61		1	1 unit	41B
	--	200	220	--	5	3RT2934-5AN61		1	1 unit	41B
	--	--	277	--	X	3RT2934-5AU61		1	1 unit	41B
	--	400	440	--	5	3RT2934-5AR61		1	1 unit	41B

Size S3

3RT204.-A,	24	--	--	--	5	3RT2944-5AB01		1	1 unit	41B
3RT234.-A,	42	--	--	--	5	3RT2944-5AD01		1	1 unit	41B
3RT244.-A,	48	--	--	--	5	3RT2944-5AH01		1	1 unit	41B
3RT254.-A	110	--	--	--	5	3RT2944-5AF01		1	1 unit	41B
	230	--	--	--	5	3RT2944-5AP01		1	1 unit	41B
	400	--	--	--	5	3RT2944-5AV01		1	1 unit	41B
	--	24	--	--	5	3RT2944-5AC21		1	1 unit	41B
		42	--	--	5	3RT2944-5AD21		1	1 unit	41B
		48	--	--	5	3RT2944-5AH21		1	1 unit	41B
		110	--	--	5	3RT2944-5AG21		1	1 unit	41B
		220	--	--	5	3RT2944-5AN21		1	1 unit	41B
		230	--	--	5	3RT2944-5AL21		1	1 unit	41B
	110	--	120	--	5	3RT2944-5AK61		1	1 unit	41B
	220	--	240	--	5	3RT2944-5AP61		1	1 unit	41B
	--	--	480	--	5	3RT2944-5AV61		1	1 unit	41B
	--	--	600	--	5	3RT2944-5AT61		1	1 unit	41B
	--	100	110	--	5	3RT2944-5AG61		1	1 unit	41B
	--	200	220	--	5	3RT2944-5AN61		1	1 unit	41B
	--	400	440	--	5	3RT2944-5AR61		1	1 unit	41B

Solenoid coils · AC/DC operation, with varistor

Size S2

3RT203.-N,	--	20 ... 33	--	20 ... 33	5	3RT2934-5NB31		1	1 unit	41B
3RT233.-N	--	30 ... 42	--	30 ... 42	X	3RT2934-5ND31		1	1 unit	41B
	--	48 ... 80	--	48 ... 80	5	3RT2934-5NE31		1	1 unit	41B
	--	83 ... 155	--	83 ... 155	X	3RT2934-5NF31		1	1 unit	41B
	--	175 ... 280	--	175 ... 280	5	3RT2934-5NP31		1	1 unit	41B

Size S3

3RT204.-N,	--	20 ... 33	--	20 ... 33	5	3RT2944-5NB31		1	1 unit	41B
3RT234.-N,	--	30 ... 42	--	30 ... 42	5	3RT2944-5ND31		1	1 unit	41B
3RT244.-N,	--	48 ... 80	--	48 ... 80	5	3RT2944-5NE31		1	1 unit	41B
3RT254.-N	--	83 ... 155	--	83 ... 155	5	3RT2944-5NF31		1	1 unit	41B
	--	175 ... 280	--	175 ... 280	5	3RT2944-5NP31		1	1 unit	41B

Note:





It is only possible to replace the coils on AC contactors with AC coils, and on AC/DC contactors with AC/DC coils.

Switching Devices – Contactors and Contactor Assemblies – for Switching Motors

Power Contactors for Switching Motors

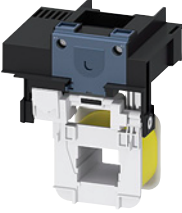
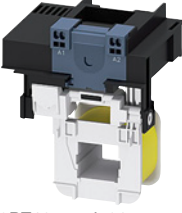
Spare parts for SIRIUS 3RT contactors and SIRIUS 3RH2 contactor relays > Solenoid coils

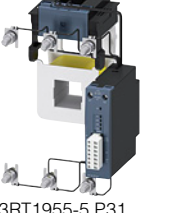
PU (UNIT, SET, M) = 1
 PS* = 1 unit
 PG = 41B

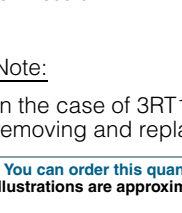
For contactors		Rated control supply voltage U_s	SD	Screw terminals	SD	Spring-loaded terminals					
Size	Type	V	d	Article No.	Price per PU	Article No.	Price per PU				
Withdrawable coils											
Standard operating mechanism for AC/DC											
 3RT1955-5A.31	S6	3RT105,	23 ... 26 AC/DC	5	3RT1955-5AB31	5	3RT1955-5AB32				
		3RT145	42 ... 48 AC/DC	5	3RT1955-5AD31	5	3RT1955-5AD32				
			110 ... 127 AC/DC	5	3RT1955-5AF31	5	3RT1955-5AF32				
			200 ... 220 AC/DC	5	3RT1955-5AM31	5	3RT1955-5AM32				
			220 ... 240 AC/DC	5	3RT1955-5AP31	5	3RT1955-5AP32				
			240 ... 277 AC/DC	5	3RT1955-5AU31	5	3RT1955-5AU32				
			380 ... 420 AC/DC	5	3RT1955-5AV31	5	3RT1955-5AV32				
			440 ... 480 AC/DC	5	3RT1955-5AR31	5	3RT1955-5AR32				
			500 ... 550 AC/DC	5	3RT1955-5AS31	5	3RT1955-5AS32				
			575 ... 600 AC/DC	5	3RT1955-5AT31	5	3RT1955-5AT32				
 3RT1955-5A.32	S10	3RT106,	23 ... 26 AC/DC	5	3RT1965-5AB31	5	3RT1965-5AB32				
		3RT146	42 ... 48 AC/DC	5	3RT1965-5AD31	5	3RT1965-5AD32				
			110 ... 127 AC/DC	5	3RT1965-5AF31	5	3RT1965-5AF32				
			200 ... 220 AC/DC	5	3RT1965-5AM31	5	3RT1965-5AM32				
			220 ... 240 AC/DC	5	3RT1965-5AP31	5	3RT1965-5AP32				
			240 ... 277 AC/DC	5	3RT1965-5AU31	5	3RT1965-5AU32				
			380 ... 420 AC/DC	5	3RT1965-5AV31	5	3RT1965-5AV32				
			440 ... 480 AC/DC	5	3RT1965-5AR31	5	3RT1965-5AR32				
			500 ... 550 AC/DC	5	3RT1965-5AS31	5	3RT1965-5AS32				
			575 ... 600 AC/DC	5	3RT1965-5AT31	5	3RT1965-5AT32				
 3RT1955-5A.32	S12	3RT107,	23 ... 26 AC/DC	5	3RT1975-5AB31	5	3RT1975-5AB32				
		3RT147	42 ... 48 AC/DC	5	3RT1975-5AD31	5	3RT1975-5AD32				
			110 ... 127 AC/DC	5	3RT1975-5AF31	5	3RT1975-5AF32				
			200 ... 220 AC/DC	5	3RT1975-5AM31	5	3RT1975-5AM32				
			220 ... 240 AC/DC	5	3RT1975-5AP31	5	3RT1975-5AP32				
			240 ... 277 AC/DC	5	3RT1975-5AU31	5	3RT1975-5AU32				
			380 ... 420 AC/DC	5	3RT1975-5AV31	5	3RT1975-5AV32				
			440 ... 480 AC/DC	5	3RT1975-5AR31	5	3RT1975-5AR32				
			500 ... 550 AC/DC	5	3RT1975-5AS31	5	3RT1975-5AS32				
			575 ... 600 AC/DC	5	3RT1975-5AT31	5	3RT1975-5AT32				
 3RT1955-5N.31	S6	3RT105,	21 ... 27.3 AC/DC	5	3RT1955-5NB31	5	3RT1955-5NB32				
		3RT145	96 ... 127 AC/DC	5	3RT1955-5NF31	5	3RT1955-5NF32				
			200 ... 277 AC/DC	5	3RT1955-5NP31	5	3RT1955-5NP32				
		 3RT1955-5N.32	S10	3RT106,	21 ... 27.3 AC/DC	5	3RT1965-5NB31	5	3RT1965-5NB32		
				3RT146	96 ... 127 AC/DC	5	3RT1965-5NF31	5	3RT1965-5NF32		
					200 ... 277 AC/DC	5	3RT1965-5NP31	5	3RT1965-5NP32		
				 3RT1955-5P.31	S12	3RT107,	21 ... 27.3 AC/DC	5	3RT1975-5NB31	5	3RT1975-5NB32
						3RT147	96 ... 127 AC/DC	5	3RT1975-5NF31	5	3RT1975-5NF32
							200 ... 277 AC/DC	5	3RT1975-5NP31	5	3RT1975-5NP32
						• Additionally with PLC relay output and remaining lifetime indicator (RLT) (withdrawable coil with laterally mounted solid-state module)					
S6	3RT105,					96 ... 127 AC/DC	5	3RT1955-5PF31		--	
	3RT145					200 ... 277 AC/DC	5	3RT1955-5PP31		--	
S10	3RT106,					96 ... 127 AC/DC	5	3RT1965-5PF31		--	
	3RT146	200 ... 277 AC/DC	5			3RT1965-5PP31		--			
S12	3RT107,	96 ... 127 AC/DC	5			3RT1975-5PF31		--			
	3RT147	200 ... 277 AC/DC	5			3RT1975-5PP31		--			
 3RT1955-5X.42	S6	3RT105...-X...-	24 DC	--	5	3RT1955-5XB42					
		OLA2	72 DC	--	5	3RT1955-5XJ42					
			110 DC	--	5	3RT1955-5XF42					
		S10	3RT106...-X...-	24 DC	--	5	3RT1965-5XB42				
			OLA2	72 DC	--	5	3RT1965-5XJ42				
				110 DC	--	5	3RT1965-5XF42				
		S12	3RT107...-X...-	24 DC	--	5	3RT1975-5XB42				
			OLA2	72 DC	--	5	3RT1975-5XJ42				
				110 DC	--	5	3RT1975-5XF42				

Note:

In the case of 3RT10...-S contactors with fail-safe control inputs, removing and replacing the operating mechanism are not permitted.









* You can order this quantity or a multiple thereof.
 Illustrations are approximate

Switching Devices – Contactors and Contactor Assemblies – for Switching Motors

Power Contactors for Switching Motors

Spare parts for SIRIUS 3RT contactors and SIRIUS 3RH2 contactor relays > Contacts and arc chutes

Selection and ordering data

For contactors		Version	SD	Article No.	Price per PU	PU (UNIT, SET, M)	PS*	PG	
Size	Type		d						
Contacts with fixing parts									
For contactors with 3 main contacts									
	3RT294.-6A	S2	3RT2035	Main contacts (3 NO contacts)	5	3RT2935-6A	1	1 unit	41B
			3RT2036	for utilization category AC-3	5	3RT2936-6A	1	1 unit	41B
			3RT2037	(1 set = 3 movable and 6 fixed switching elements with fixing parts)	5	3RT2937-6A	1	1 unit	41B
			3RT2038		5	3RT2938-6A	1	1 unit	41B
	3RT1954-6A	S3	3RT2045		5	3RT2945-6A	1	1 unit	41B
			3RT2046		5	3RT2946-6A	1	1 unit	41B
			3RT2047		5	3RT2947-6A	1	1 unit	41B
	3RT1954-6A	S6	3RT1054		▶	3RT1954-6A	1	1 unit	41B
			3RT1055		▶	3RT1955-6A	1	1 unit	41B
			3RT1056		▶	3RT1956-6A	1	1 unit	41B
	3RT1954-6A	S10	3RT1064		▶	3RT1964-6A	1	1 unit	41B
			3RT1065		▶	3RT1965-6A	1	1 unit	41B
			3RT1066		▶	3RT1966-6A	1	1 unit	41B
	3RT197.-6A, 3RT1976-6D	S12	3RT1075		▶	3RT1975-6A	1	1 unit	41B
			3RT1076		2	3RT1976-6A	1	1 unit	41B
	3RT197.-6A, 3RT1976-6D	S3	3RT2446	Main contacts (3 NO contacts)	10	3RT2946-6D	1	1 unit	41B
			3RT2448	for utilization category AC-1	10	3RT2948-6D	1	1 unit	41B
		S6	3RT1456	(1 set = 3 movable and 6 fixed switching elements with fixing parts)	5	3RT1956-6D	1	1 unit	41B
		S10	3RT1466		5	3RT1966-6D	1	1 unit	41B
	3RT1467	10	3RT1967-6D	1	1 unit	41B			
	3RT1476	5	3RT1976-6D			1	1 unit	41B	
For contactors with 4 main contacts									
	3RT2936-6E	S2	3RT2336	Main contacts (4 NO contacts)	10	3RT2936-6E	1	1 unit	41B
			3RT2337	for utilization category AC-1	10	3RT2937-6E	1	1 unit	41B
Arc chutes									
For contactors with 3 main contacts									
	3RT195.-7.	S6	3RT1054	Only for contactors with AC/DC coil	5	3RT1954-7A	1	1 unit	41B
			3RT1055		5	3RT1955-7A	1	1 unit	41B
			3RT1056		5	3RT1956-7A	1	1 unit	41B
			3RT1456		5	3RT1956-7B	1	1 unit	41B
	3RT196.-7.	S10	3RT1064		5	3RT1964-7A	1	1 unit	41B
			3RT1065		5	3RT1965-7A	1	1 unit	41B
			3RT1066		5	3RT1966-7A	1	1 unit	41B
			3RT1466		5	3RT1966-7B	1	1 unit	41B
	3RT197.-7.	S12	3RT1075		5	3RT1975-7A	1	1 unit	41B
			3RT1076		5	3RT1976-7A	1	1 unit	41B
			3RT1476		5	3RT1976-7B	1	1 unit	41B

Switching Devices – Contactors and Contactor Assemblies – for Switching Motors

Power Contactors for Switching Motors

SIRIUS 3RT12 and 3TF6 vacuum contactors

Overview

Vacuum contactors

Standards

IEC/EN 60947-1,
IEC/EN 60947-4-1,
IEC/EN 60947-5-1 (auxiliary switches)

The SIRIUS 3RT12 and 3TF68/3TF69 vacuum contactors are suitable for use in any climate. They are finger-safe according to IEC 60529. Terminal covers may have to be fitted onto the connecting bars, depending on the configuration with other devices (see pages 3/117 and 3/138).

Connection methods

The vacuum contactors are available with screw terminals (box terminals).

Contact reliability

If voltages ≤ 110 V and currents ≤ 100 mA are to be switched, the auxiliary contacts of the vacuum contactors or 3RH contactor relays should be used as they guarantee a high level of contact reliability.

These auxiliary contacts are particularly suitable for solid-state circuits with currents ≥ 1 mA at a voltage ≥ 17 V.

Short-circuit protection

For short-circuit protection of vacuum contactors with or without overload relays, refer to the Equipment Manuals and Configuration Manuals, see "More information" on page 3/126.

Electromagnetic compatibility (EMC)

The contactors with solid-state operating mechanism comply with the international standards IEC/EN 60947-1 and IEC/EN 60947-4-1.

These contactors have been developed for environment A.

Note:

Environment A refers to private low-voltage or industrial networks/locations/plants, including high-grade sources of interference.

Environment A corresponds to devices of Class A with CISPR 11, EN 55011.

Note:

In connection with converters, the control cables must be routed separately from the load cables to the converter.

Motor protection

For protection against overload, 3RB2 electronic overload relays (see page 7/117 onwards) can be mounted onto the vacuum contactors. These must be ordered separately.

Ratings of three-phase motors

The quoted rating (in kW) refers to the output power on the motor shaft (according to the nameplate).

The power rating specifications of the vacuum contactors in kW are guide values for 4-pole standard motors at 50 Hz AC and specified voltage (e.g. 400 V). The specific starting and rated data of the motor to be switched are decisive when it comes to selecting the right devices, and the motor current, motor protection device and the permissible contactor current according to the utilization category must be aligned with each other when doing so.

Surge suppression

The vacuum contactors can be retrofitted with varistors for damping opening overvoltages in the coil.

Note:

The OFF-delay of the NO contact and the ON-delay of the NC contact are increased if the contactor coils are attenuated against voltage peaks (varistor +2 to 5 ms)

Vacuum contactors are basically unsuitable for switching DC voltage.

SIRIUS 3RT12 vacuum contactors, 3-pole, 110 to 250 kW

AC/DC operation

The contactors can be operated with AC (50 to 60 Hz) as well as with DC.

Two types of solenoid operation are available:

- Standard operating mechanism with economy circuit for AC and DC operation (switchover from closing coil to holding coil), version 3RT12..-A
- Solid-state operating mechanism, version 3RT12..-N

Withdrawable coils

For simple coil replacement, e.g. if the application is replaced, the solenoid coil can be pulled out upwards after the release mechanism has been actuated and can be replaced by any other coil of the same size.

Vacuum interrupters

In contrast to the 3RT10 contactors – the main contacts operate in air under atmospheric conditions – the contact gaps of the 3RT12 vacuum contactors are contained in hermetically enclosed vacuum interrupters. Neither arcs nor arcing gases are produced. The particular benefit of 3RT12 vacuum contactors, however, is that their electrical endurance is at least twice as long as that of 3RT10 contactors. They are therefore particularly well suited to frequent switching in inching/mixed operation, e.g. in crane control systems.

Auxiliary contact complement

The 3RT12 vacuum contactors of sizes S10 to S12 are supplied with laterally mounted auxiliary switches. These can be fitted with up to eight lateral auxiliary contacts (identical auxiliary switches for S10 and S12). Of these, no more than four are permitted to be NC contacts.

3TF6 vacuum contactors, 3-pole, 335 to 450 kW

Main contacts

Contact erosion indication with 3TF68/3TF69 vacuum contactors:

The contact erosion of the vacuum interrupters can be checked during operation with the help of three white double slides on the contactor base. If the distance indicated by one of the double slides is < 0.5 mm while the contactor is in the closed position, the vacuum interrupter must be replaced. To ensure maximum reliability, it is recommended to replace all three vacuum interrupters simultaneously.

Switching Devices – Contactors and Contactor Assemblies – for Switching Motors

Power Contactors for Switching Motors

SIRIUS 3RT12 and 3TF6 vacuum contactors

Auxiliary contacts

Contact reliability:

These auxiliary contacts are particularly suitable for solid-state circuits with currents ≥ 1 mA at a voltage ≥ 17 V.

Protection of the main current paths

An integrated RC varistor connection for the main current paths dampens the switching overvoltage rises to safe values. This prevents multiple restricting. It can therefore be assumed that the motor winding cannot be damaged by switching overvoltages with steep voltage rises.

During operation in installations in which the emitted interference limits cannot be observed, e.g. when used for output contactors in converters, 3TF68/3TF69..-Q vacuum contactors – without connection of the main current path circuit – are recommended.

Technical specifications

Unless otherwise listed on subsequent pages, the technical specifications of the SIRIUS 3RT12 vacuum contactors correspond to those of the 3RT10 basic units, see pages 3/22, and 3/47 to 3/53.

More information

Technical specifications, see

<https://support.industry.siemens.com/cs/ww/en/ps/16137/td>

FAQs, see

<https://support.industry.siemens.com/cs/ww/en/ps/16137/faq>

System Manual "SIRIUS – System Overview", see

<https://support.industry.siemens.com/cs/ww/en/view/60311318>

Equipment Manual "SIRIUS – SIRIUS 3RT Contactors/Contactor Assemblies", see <https://support.industry.siemens.com/cs/ww/en/view/60306557>

Application Manual "SIRIUS Controls with IE3/IE4 motors", see <https://support.industry.siemens.com/cs/ww/en/view/94770820>

Configuration Manual "Load Feeders – Configuring the SIRIUS Modular System", see <https://support.industry.siemens.com/cs/ww/en/view/39714188>

Configuration Manual "Configuring SIRIUS Innovations UL", see <https://support.industry.siemens.com/cs/ww/en/view/53433538>

Type

Size

SIRIUS vacuum contactors

3RT12

S10 and S12

Contact endurance of the main contacts

The characteristic curves show the contact endurance of the contactors when switching resistive and inductive AC loads (AC-1/AC-3) depending on the breaking current and rated operational voltage. It is assumed that the operating mechanisms are switched randomly, i.e. not synchronized with the phase angle of the supply system.

The rated operational current I_e complies with utilization category AC-4 (breaking 6 times the rated operational current) and is intended for a contact endurance of approximately 200 000 operating cycles.

If a shorter contact endurance is sufficient, the rated operational current $I_e/AC-4$ can be increased.

If the contacts are used for mixed operation, i.e. normal switching (breaking the rated operational current according to utilization category AC-3) in combination with intermittent inching (breaking several times the rated operational current according to utilization category AC-4), the contact endurance can be calculated approximately from the following equation:

$$X = \frac{A}{1 + \frac{C}{100} \left(\frac{A}{B} - 1 \right)}$$

Characters in the equation:

X Contact endurance for mixed operation in operating cycles

A Contact endurance for normal operation ($I_a = I_e$) in operating cycles

B Contact endurance for inching ($I_a =$ multiple of I_e) in operating cycles

C Inching operations as a percentage of total switching operations

Operating cycles at

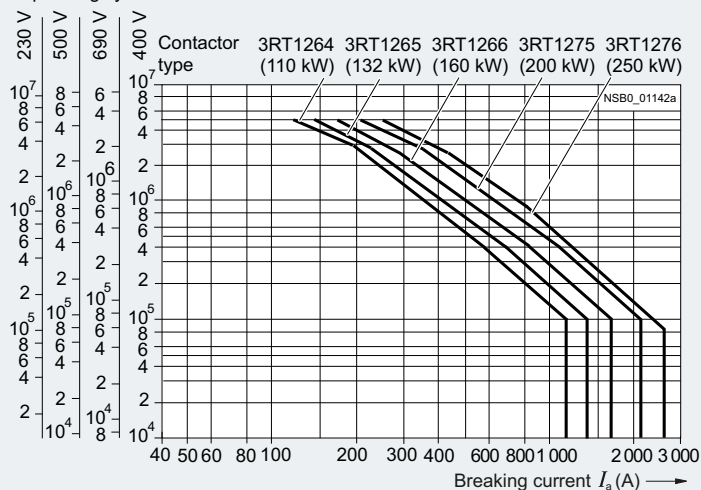

Switching Devices – Contactors and Contactor Assemblies – for Switching Motors

Power Contactors for Switching Motors

SIRIUS 3RT12 and 3TF6 vacuum contactors

Type	Vacuum contactors		
Size	3TF6		
14			
Rated data of the auxiliary contacts		According to IEC 60947-5-1	
Rated insulation voltage U_i (pollution degree 3)	V	690	
Conventional thermal current $I_{th} = \text{rated operational current } I_e/\text{AC-12}$	A	10	
AC load			
Rated operational current $I_e/\text{AC-15/AC-14}$			
• At rated operational voltage U_e			
- At 24 V	A	10	
- At 110 V	A	10	
- At 125 V	A	10	
- At 220 V	A	6	
- At 230 V	A	5.6	
- At 380 V	A	4	
- At 400 V	A	3.6	
- At 500 V	A	2.5	
- At 660 V	A	2.5	
- At 690 V	A	2.3	
DC load			
Rated operational current $I_e/\text{DC-12}$			
• At rated operational voltage U_e			
- At 24 V	A	10	
- At 60 V	A	10	
- At 110 V	A	3.2	
- At 125 V	A	2.5	
- At 220 V	A	0.9	
- At 440 V	A	0.33	
- At 600 V	A	0.22	
Rated operational current $I_e/\text{DC-13}$		Auxiliary contacts with delayed NC contact:	
• At rated operational voltage U_e		N S = No specification	
- At 24 V	A	10	6
- At 60 V	A	5	N S
- At 110 V	A	1.14	0.98
- At 125 V	A	0.98	N S
- At 220 V	A	0.48	N S
- At 440 V	A	0.13	N S
- At 600 V	A	0.07	0.07

Ⓢ and Ⓣ rated data of the auxiliary contacts

Rated voltage, max. V AC 600

Switching capacity A 600, P 600

Endurance of the auxiliary contacts

The contact endurance for utilization category AC-12 or AC-15/AC-14 depends mainly on the breaking current. It is assumed that the operating mechanisms are switched randomly, i.e. not synchronized with the phase angle of the supply system.

The characteristic curves apply to 230 V AC.

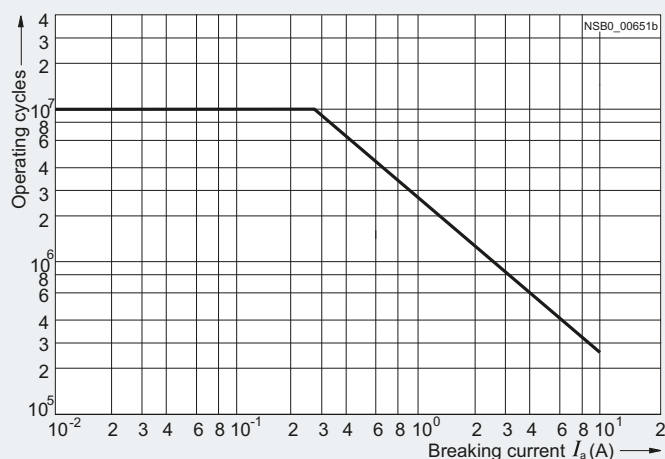

Contact erosion indication with vacuum contactors

The contact erosion of the vacuum interrupters can be checked during operation with the help of three white double slides on the contactor base.

If the distance indicated by one of the double slides is < 0.5 mm while the contactor is in the closed position, the vacuum interrupter must be replaced. To ensure maximum reliability, it is recommended to replace all three vacuum interrupters at once.

Switching Devices – Contactors and Contactor Assemblies – for Switching Motors

Power Contactors for Switching Motors

SIRIUS 3RT12 and 3TF6 vacuum contactors

Type
Size

Vacuum contactors
3TF6
14

Contact endurance of the main contacts

The characteristic curves show the contact endurance of the contactors when switching resistive and inductive AC loads (AC-1/AC-3) depending on the breaking current and rated operational voltage. It is assumed that the operating mechanisms are switched randomly, i.e. not synchronized with the phase angle of the supply system.

The rated operational current I_e complies with utilization category AC-4 (breaking 6 times the rated operational current) and is intended for a contact endurance of approximately 200 000 operating cycles.

If a shorter contact endurance is sufficient, the rated operational current $I_e/AC-4$ can be increased.

If the contacts are used for mixed operation, i.e. normal switching (breaking the rated operational current according to utilization category AC-3) in combination with intermittent inching (breaking several times the rated operational current according to utilization category AC-4), the contact endurance can be calculated approximately from the following equation:

$$X = \frac{A}{1 + \frac{C}{100} \left(\frac{A}{B} - 1 \right)}$$

Characters in the equation:

- X Contact endurance for mixed operation in operating cycles
- A Contact endurance for normal operation ($I_a = I_e$) in operating cycles
- B Contact endurance for inching ($I_a = \text{multiple of } I_e$) in operating cycles
- C Inching operations as a percentage of total switching operations

Operating cycles at

230 V 500 V 690 V 400 V

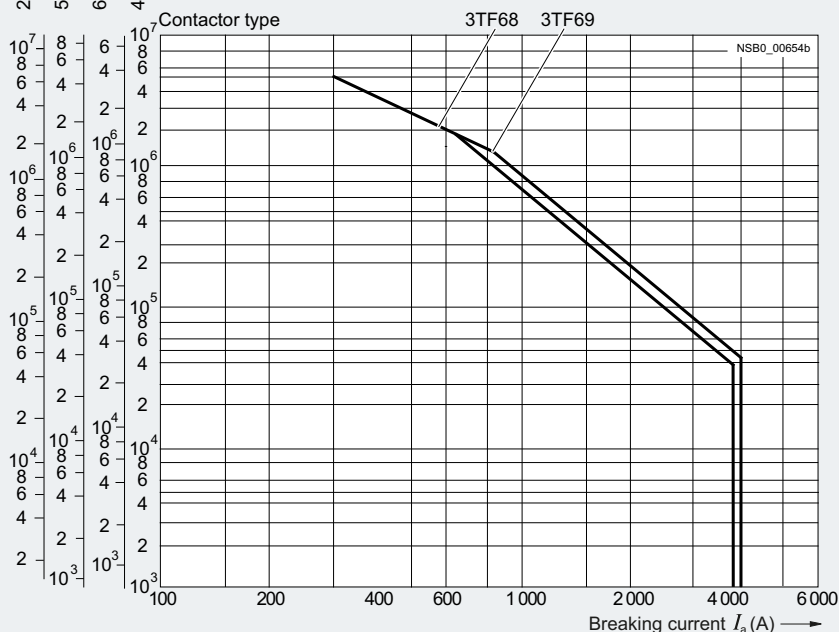

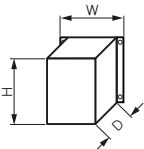
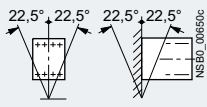
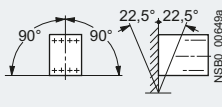
		SIRIUS vacuum contactors		Vacuum contactors	
Type		3RT126	3RT127	3TF68	3TF69
Size		S10	S12	14	
General data					
Dimensions (W x H x D)	 mm	145 x 210 x 206	160 x 214 x 225	230 x 276 x 237	230 x 295 x 237
Permissible mounting position	The contactors are designed for operation on a vertical mounting surface.				
<ul style="list-style-type: none"> • To easily replace the laterally mounted auxiliary switches it is recommended to maintain a minimum distance of 30 mm between the contactors. • If mounted at a 90° angle (current paths are horizontally above each other), the switching frequency is reduced by 80% compared with the normal values. 		No	No	Yes	Yes
Mechanical endurance	Operating cycles	10 million		5 million	
Electrical endurance	Contact endurance of the main contacts	See page 3/126		See above	
Rated insulation voltage U_i	kV (pollution degree 3)	1			
Rated impulse withstand voltage U_{imp}	kV	8			
Protective separation between the coil and the main contacts acc. to IEC 60947-1, Appendix N	V	690		1 000	
Mirror contacts		Yes, acc. to IEC 60947-4-1, Appendix F		Yes, acc. to IEC 60947-4-1, Appendix F	
	A mirror contact is an auxiliary NC contact that cannot be closed simultaneously with an NO main contact.			One NC contact each must be connected in series for the left and right auxiliary switch respectively.	

Switching Devices – Contactors and Contactor Assemblies – for Switching Motors

Power Contactors for Switching Motors

SIRIUS 3RT12 and 3TF6 vacuum contactors

Type Size	SIRIUS vacuum contactors		Vacuum contactors	
	3RT126 S10	3RT127 S12	3TF68 14	3TF69
General data (continued)				
Permissible ambient temperature				
• During operation	°C	-25 ... +60	-25 ... +55 ¹⁾	
• During storage	°C	-55 ... +80	-55 ... +80	
Degree of protection acc. to IEC 60529				
• On front		IP00 (IP20 with box terminal/cover)	2)3)	
• Connecting terminal		IP00 (for higher degree of protection, use additional terminal covers)		
Touch protection acc. to IEC 60529				
		Finger-safe for vertical touching from the front with cover		
Shock resistance				
• Rectangular pulse				
- AC operation	g/ms	8.5/5 and 4.2/10	8.1/5 and 4.7/10	9.5/5 and 5.7/10
- DC operation	g/ms	8.5/5 and 4.2/10	9/5 and 5.7/10	8.6/5 and 5.1/10
• Sine pulse				
- AC operation	g/ms	13.4/5 and 6.5/10	12.8/5 and 7.4/10	13.5/5 and 7.8/10
- DC operation	g/ms	13.4/5 and 6.5/10	14.4/5 and 9.1/10	13.5/5 and 7.8/10
Electromagnetic compatibility (EMC)				
		See page 3/125		
Short-circuit protection				
Main circuit				
Fuse links, operational class gG: LV HRC, type 3NA; DIAZED, type 5SB; NEOZED, type 5SE acc. to IEC/EN 60947-4-1				
• Type of coordination "1"	A	500	800	1 000
• Type of coordination "2"	A	500	800	630
• Weld-free (test conditions acc. to IEC 60947-4-1)	A	400	500	400
Auxiliary circuit				
Short-circuit test				
• Fuse links, operational class gG: DIAZED, type 5SB; NEOZED, type 5SE (weld-free protection at $I_k \leq 1$ kA)	A	10		
• Miniature circuit breaker with C characteristic (short-circuit current $I_k \leq 400$ A)	A	10		
Short-circuit protection for contactors with overload relays				
		See Configuration Manual for load feeders		

¹⁾ For ambient temperatures > 55 °C, only 3TF6.33-.Q..-Z A02 contactors (= without connection of the main current path circuits) can be used. However, derating must be taken into account for these contactors too:
- AC-1: $I_g = 782$ A, 644 operating cycles/h;
- AC-3: Operating range 0.85 to 1.05 x U_g , 460 operating cycles/h, mech. endurance 5 million operating cycles, lateral clearance 10 mm.

²⁾ The following applies for 3TF6.-.C.:
- IP00 without cover (the connecting bar is reached directly from the front)
- IP00 with cover for conductor entry
- IP20 on the front plate with cover.
³⁾ The following applies for 3TF6.-.Q../-D.:
- IP00 without box terminal (the connecting bar, series resistor and the 3TC44 reversing contactor are reached directly from the front)
- IP00 with box terminal (the series resistor and the 3TC44 reversing contactor are reached directly).

Switching Devices – Contactors and Contactor Assemblies – for Switching Motors

Power Contactors for Switching Motors

SIRIUS 3RT12 and 3TF6 vacuum contactors

Type Size	SIRIUS vacuum contactors		Vacuum contactors	
	3RT126 S10	3RT127 S12	3TF68 14	3TF69
Control				
Solenoid coil operating range	AC/DC	0.8 x $U_{s \text{ min}}$... 1.1 x $U_{s \text{ max}}$		
Power consumption of the solenoid coils (for cold coil and 1.0 x U_s)				
<u>Standard operating mechanism</u>				
• AC operation				
- Closing at $U_{s \text{ min}}/U_{s \text{ max}}$	VA	530/630	700/830	--
- P.f.		0.9		--
- Closed at $U_{s \text{ min}}/U_{s \text{ max}}$	VA	6.1/7.4	7.6/9.2	--
- P.f.		0.9		--
• DC operation				
- Closing at $U_{s \text{ min}}/U_{s \text{ max}}$	W	580/780	770/920	--
- Closed at $U_{s \text{ min}}/U_{s \text{ max}}$	W	6.8/8.2	8.5/10	--
<u>Solid-state operating mechanism</u>				
• AC operation				
- Closing at $U_{s \text{ min}}/U_{s \text{ max}}$	VA	420/570	560/750	1 200/1 850
- P.f.		0.8		1
- Closed at $U_{s \text{ min}}/U_{s \text{ max}}$	VA	5.5/8.5	5.6/9	13.5/49
- P.f.		0.5/0.4		0.15
• AC operation for 3TF68/3TF69...Q				
- Closing at $U_{s \text{ min}}$	VA	--		1 000
- P.f.		--		0.99
- Closed at $U_{s \text{ min}}$	VA	--		11
- P.f.		--		1
• DC operation				
- Closing at $U_{s \text{ min}}/U_{s \text{ max}}$	W	460/630	600/800	--
- Closed at $U_{s \text{ min}}/U_{s \text{ max}}$	W	2.8/3.4	3/3.6	--
• DC economy circuit ¹⁾				
- Closing at $U_{s \text{ min}}$	W	--		1 010
- Closed at $U_{s \text{ min}}$	W	--		28
• 960				20.6
PLC control input acc. to IEC 61131-2				
• Rated voltage	V DC	Type 2		--
• Operating range	V DC	24		--
• Power consumption	mA	17 ... 30		--
• ≤ 30				--
Operating times (Total break time = Opening delay + Arcing time)				
(Values apply to cold and warm coil)				
<u>Standard operating mechanism</u>				
• For 0.8 x $U_{s \text{ min}}$... 1.1 x $U_{s \text{ max}}$				
- Closing delay	ms	30 ... 95	45 ... 100	--
- Opening delay	ms	40 ... 80	60 ... 100	--
• For $U_{s \text{ min}}$... $U_{s \text{ max}}$				
- Closing delay	ms	35 ... 50	50 ... 70	--
- Opening delay	ms	50 ... 80	70 ... 100	--
<u>Solid-state operating mechanism, actuated via A1/A2</u>				
• AC operation at 0.8 x $U_{s \text{ min}}$... 1.1 x $U_{s \text{ max}}$				
- Closing delay	ms	105 ... 145	120 ... 150	70 ... 120 (22 ... 65)
- Opening delay	ms	80 ... 100		80 ... 120
• AC operation for 3TF68/3TF69...Q at $U_{s \text{ min}}$ (including reversing contactor)				
- Closing delay	ms	--		35 ... 90
- Opening delay	ms	--		65 ... 90
• AC operation at $U_{s \text{ min}}$... $U_{s \text{ max}}$				
- Closing delay	ms	110 ... 130	125 ... 150	80 ... 100 (30 ... 45)
- Opening delay	ms	80 ... 100		85 ... 100
• 70				70
<u>Solid-state operating mechanism, actuated via PLC input</u>				
• For 0.8 x $U_{s \text{ min}}$... 1.1 x $U_{s \text{ max}}$				
- Closing delay	ms	45 ... 80	60 ... 90	--
- Opening delay	ms	80 ... 100		--
• DC economy circuit for 0.8 x $U_{s \text{ min}}$... 1.1 x $U_{s \text{ max}}$				
- Closing delay	ms	--		76 ... 110
- Opening delay	ms	--		50
• For $U_{s \text{ min}}$... $U_{s \text{ max}}$				
- Closing delay	ms	50 ... 65	65 ... 80	--
- Opening delay	ms	80 ... 100		--
• DC economy circuit for $U_{s \text{ min}}$... $U_{s \text{ max}}$				
- Closing delay	ms	--		80 ... 90
- Opening delay	ms	--		50
• 90				19 ... 25
• 90 ... 125				19 ... 25
Arcing time				
	ms	10 ... 15		10 ... 15
Minimum command duration				
For closing	Standard	ms	--	120
	Reduced make-time	ms	--	90
Minimum interval time between two ON commands				
	ms	--		100
				300

¹⁾ At 24 V DC; for further voltages, deviations of up to ± 10% are possible.

Switching Devices – Contactors and Contactor Assemblies – for Switching Motors

Power Contactors for Switching Motors

SIRIUS 3RT12 and 3TF6 vacuum contactors

Type Size	SIRIUS vacuum contactors					Vacuum contactors			
	3RT1264	3RT1265	3RT1266	3RT1275	3RT1276	3TF68	3TF69		
	S10			S12		14			
Rated data of the main contacts									
Load rating with AC									
Utilization category AC-1, switching resistive loads									
• Rated operational currents I_e	- At 40 °C up to 690 V - At 40 °C up to 1 000 V - At 55 °C up to 690 V - At 55 °C up to 1 000 V - At 60 °C up to 1 000 V	A A A A A	330 330 -- -- 300		610 610 -- -- 550		700 -- 630 450 --	910 -- 850 800 --	
• Rated power for AC loads ¹⁾ with p.f. = 0.95	- At 230 V - At 400 V - At 500 V - At 690 V - At 1 000 V	kW kW kW kW kW	113 197 246 340 492		At 60 °C 208 362 452 624 905	At 60 °C	At 55 °C 240 415 545 720 780	At 55 °C 323 558 735 970 1 385	
• Minimum cross-section in the main circuit for max. AC-1 rated value		mm ²	185		370		480	$I_e \geq 800$ A: 2 x 60 x 5 (copper busbars)	
Utilization categories AC-2 and AC-3									
• Rated operational currents I_e	- Up to 690 V - Up to 1 000 V	A A	-- 225	265	300	400	500	630 435	820 580
• Rated power for slipring or squirrel-cage motors at 50 and 60 Hz	- At 230 V - At 400 V - At 500 V - At 690 V - At 1 000 V	kW kW kW kW kW	73 128 160 223 320	85 151 189 265 378	97 171 215 288 428	132 231 291 400 578	164 291 363 507 728	200 347 434 600 800	260 450 600 800 800
Thermal load capacity, 10 s current		A	1 800	2 120	2 400	3 200	4 000	5 040	7 000
Power loss per conducting path at $I_e/AC-3$		W	9	12	14	21	32	45	70
Utilization category AC-4 (for $I_a = 6 \times I_e$)									
Maximum values:									
• Rated operational current I_e	- Up to 690 V	A	195	230	280	350	430	610	690
• Rated power for squirrel-cage motors with 50 Hz and 60 Hz	- At 400 V	kW	110	132	160	200	250	355	400
The following applies to a contact endurance of about 200 000 operating cycles:									
• Rated operational currents I_e	- Up to 690 V - Up to 1 000 V	A A	97 68	115 81	140 98	175 123	215 151	300 210	360 250
• Rated power for squirrel-cage motors with 50 Hz and 60 Hz	- At 230 V - At 400 V - At 500 V - At 690 V - At 1 000 V	kW kW kW kW kW	30 55 68 94 95	37 65 81 112 114	45 79 98 138 140	56 98 124 172 183	70 122 153 212 217	97 168 210 ²⁾ 278 ²⁾ 290 ²⁾	110 191 250 ²⁾ 335 ²⁾ 350 ²⁾
Switching frequency									
Switching frequency z in operating cycles/hour									
Contactors without overload relays									
• No-load switching frequency	- AC/DC	1/h	Standard operating mechanism: 2 000, Solid-state operating mechanism: 1 000					--	
	- AC	1/h						2 000	
	- DC	1/h						1 000	
• Switching frequency z during rated operation ³⁾	- $I_e/AC-1$ at 400 V - $I_e/AC-2$ at 400 V - $I_e/AC-3$ at 400 V - $I_e/AC-4$ at 400 V	1/h 1/h 1/h 1/h	800 300 750 250	750 250			700 200 500 150	1 000	
Contactors with overload relays									
• Mean value		1/h	60					15	

¹⁾ Industrial furnaces and electric heaters with resistance heating, etc. (increased power consumption on heating up has been taken into account).





²⁾ Max. permissible rated operational current $I_e/AC-4 = I_e/AC-3$ up to 500 V, for reduced contact endurance and reduced switching frequency.

³⁾ Dependence of the switching frequency z' on the operational current I' and operational voltage U':
 $z' = z \cdot (I_e/I) \cdot (U_e/U)^{1.5} \cdot 1/h$.

Switching Devices – Contactors and Contactor Assemblies – for Switching Motors

Power Contactors for Switching Motors

SIRIUS 3RT12 and 3TF6 vacuum contactors

Type Size	SIRIUS vacuum contactors		Vacuum contactors	
	3RT126. S10	3RT127. S12	3TF68 14	3TF69
Conductor cross-sections				
Main conductors (1 or 2 conductors can be connected)				
 Screw terminals				
With mounted box terminals	Type	3RT1966-4G		--
• Terminal screws - Tightening torque	Nm	M12 (hexagon socket, A/F 5) 20 ... 22 (180 ... 195 lb.in)		--
Front clamping point connected				
	• Finely stranded with end sleeve (DIN 46228)	mm ²	70 ... 240	--
	• Finely stranded without end sleeve	mm ²	70 ... 240	--
	• Stranded	mm ²	95 ... 300	--
	• AWG cables, solid or stranded	AWG	3/0 ... 600 kcmil	--
• Ribbon cable conductors (number x width x thickness)	mm	Min. 6 x 9 x 0.8; max. 20 x 24 x 0.5		--
Rear clamping point connected				
	• Finely stranded with end sleeve (DIN 46228)	mm ²	120 ... 185	--
	• Finely stranded without end sleeve	mm ²	120 ... 185	--
	• Stranded	mm ²	120 ... 240	--
	• AWG cables, solid or stranded	AWG	250 ... 500 kcmil	--
• Ribbon cable conductors (number x width x thickness)	mm	Min. 6 x 9 x 0.8; max. 20 x 24 x 0.5		--
Both clamping points connected				
	• Finely stranded with end sleeve (DIN 46228)	mm ²	Min. 2 x 50, max. 2 x 185	--
	• Finely stranded without end sleeve	mm ²	Min. 2 x 50, max. 2 x 185	--
	• Stranded	mm ²	Min. 2 x 70, max. 2 x 240	--
	• AWG cables, solid or stranded	AWG	Min. 2 x 2/0, max. 1 x 500 kcmil	--
• Ribbon cable conductors (number x width x thickness)	mm	Max. 2 x (20 x 24 x 0.5)		--
Cable lug connection				
• Finely stranded with cable lug ¹⁾	mm ²	50 ... 240		--
• Stranded with cable lug ¹⁾	mm ²	70 ... 240		--
• AWG cables, solid or stranded	AWG	2/0 ... 500 kcmil		--
• Terminal screws - Tightening torque	Nm	M10 x 30 (A/F 17) 14 ... 24 (124 ... 210 lb.in)		--
Busbar connections				
• Finely stranded with cable lug	mm ²	--	50 ... 240	
• Stranded with cable lug	mm ²	--	70 ... 240	50 ... 240
• Solid or stranded	AWG	--	2/0 ... 500 MCM	2/0 ... 500 MCM
• Connecting bar (max. width)	mm	25	50	60 ($U_b \leq 690$ V), 50 ($U_b > 690$ V)
• Terminal screws - Tightening torque	Nm lb.in	-- --	M10 x 30 14 ... 24 124 ... 210	M12 x 40 20 ... 35 177 ... 310
With box terminal (see page 3/138)				
• Connectable laminated copper bars		--	Yes	
• Width	mm	--	15 ... 25	15 ... 38
• Max. thickness	mm	--	1 x 26 or 2 x 11	1 x 46 or 2 x 18
• Terminal screw		--	A/F 6 (hexagon socket)	A/F 8 (hexagon socket)
• Tightening torque	Nm	--	25 ... 40 (221 ... 354 lb.in)	35 ... 50 (266 ... 443 lb.in)
Auxiliary conductors (1 or 2 conductors can be connected)				
• Solid	mm ²	2 x (0.5 ... 1.5) ²⁾ ; 2 x (0.75 ... 2.5) ²⁾ acc. to IEC 60947; max. 2 x (0.75 ... 4)		2 x (0.5 ... 1) ²⁾ /2 x (1 ... 2.5) ²⁾
• Finely stranded with end sleeve (DIN 46228)	mm ²	2 x (0.5 ... 1.5) ²⁾ ; 2 x (0.75 ... 2.5) ²⁾		2 x (0.5 ... 1) ²⁾ ; 2 x (0.75 ... 2.5) ²⁾
• Pin-end connector to DIN 46231	mm ²	--		2 x (1 ... 1.5)
• AWG cables, solid or stranded	AWG	2 x (18 ... 14)		2 x (18 ... 12)
• Terminal screws - Tightening torque	Nm	M3 (Pozidriv size 2) 0.8 ... 1.2 (7 ... 10.3 lb.in)		-- 0.8 ... 1.4 (7 ... 12 lb.in)

¹⁾ When connecting cable lugs according to DIN 46234 for conductor cross-sections larger than 240 mm² and according to DIN 46235 for conductor cross-sections larger than 185 mm², the 3RT1966-4EA1 terminal cover is required to maintain the phase clearance, see page 3/117.

²⁾ If two different conductor cross-sections are connected to one clamping point, both cross-sections must lie in one of the ranges specified.

Switching Devices – Contactors and Contactor Assemblies – for Switching Motors

Power Contactors for Switching Motors

SIRIUS 3RT12 and 3TF6 vacuum contactors

Type Size	SIRIUS vacuum contactors					Vacuum contactors		
	3RT1264 S10	3RT1265	3RT1266	3RT1275 S12	3RT1276	3TF68 14	3TF69	
and rated data								
Rated insulation voltage	V AC	600					600	
Uninterrupted current at 40 °C, open and enclosed	A	330			540		630	820
Maximum horsepower ratings (from and approved values)								
• Rated power for three-phase motors at 60 Hz								
- At 200 V	hp	60	75	100	125	150	231	290
- At 230 V	hp	75	100	125	150	200	266	350
- At 460 V	hp	150	200	250	300	400	530	700
- At 575 V	hp	200	250	300	400	500	664	860
NEMA/EEMAC ratings								
SIZE	hp	--					6	7
• Uninterrupted current								
- Open	A	--					600	820
- Enclosed	A	--					540	810
• Rated power for three-phase motors at 60 Hz								
- At 200 V	hp	--					150	--
- At 230 V	hp	--					200	300
- At 460 V	hp	--					400	600
- At 575 V	hp	--					400	600
Short-circuit protection¹⁾								
	kA	10	18			30	100	
• CLASS L fuse	A	600	700	800	1 000	1 200	1 600	
• Circuit breakers acc. to UL 489	A	500	700	800	1 000	1 200	On request ¹⁾	

¹⁾ For more information about short-circuit values, e.g. for protection against short-circuit currents, see [Certificate of Compliance for the individual devices](#).

For the selection and dimensioning of load feeders, see [UL Configuration Manual](#) and the [UL guide "Competitive control panels for the North American market"](#).

Switching Devices – Contactors and Contactor Assemblies – for Switching Motors

Power Contactors for Switching Motors

SIRIUS 3RT12 and 3TF6 vacuum contactors **IE3/IE4 ready**

Selection and ordering data

SIRIUS 3RT12 vacuum contactors, 3-pole, 110 ... 250 kW

AC/DC operation 



- Standard operating mechanism 3RT12...-A
- 3RT12...-N solid-state operating mechanism with 24 V DC control signal input
- For screw fixing
- Auxiliary and control conductors: Screw terminals
- Main conductors: Busbar connections; a connection kit with screws, spring washers and nuts is enclosed.



3RT1264-6AF36



3RT127.-6N.36

Size	Rated data					AC-1, t_u : 40 °C	Auxiliary contacts, lateral		Rated control supply voltage U_s 50/60 Hz AC or DC	SD	Screw terminals 	PU (UNIT, SET, M)	PS*	PG
	AC-2 and AC-3, t_u : Up to 60 °C	Rating of three-phase motors at 50 Hz and					Operational current I_e up to	NO						
Operational current I_e up to	1 000 V	230 V	400 V	500 V	690 V	1 000 V			 		d			
A	kW	kW	kW	kW	A									

Standard operating mechanism with economy circuit for AC and DC operation (switchover from closing coil to holding coil)

With integrated coil circuit (varistor integrated at the factory)

S10	225	55	110	160	200	330	2	2	110 ... 127 220 ... 240	X X	3RT1264-6AF36 3RT1264-6AP36	1 1	1 unit 1 unit	41B 41B
	265	75	132	160	250	330	2	2	110 ... 127 220 ... 240	X X	3RT1265-6AF36 3RT1265-6AP36	1 1	1 unit 1 unit	41B 41B
	300	90	160 ¹⁾	200	250	330	2	2	110 ... 127 220 ... 240	X X	3RT1266-6AF36 3RT1266-6AP36	1 1	1 unit 1 unit	41B 41B
S12	400	132	200	250	400	610	2	2	110 ... 127 220 ... 240	X X	3RT1275-6AF36 3RT1275-6AP36	1 1	1 unit 1 unit	41B 41B
	500	160	250 ¹⁾	355	500	610	2	2	110 ... 127 220 ... 240	X X	3RT1276-6AF36 3RT1276-6AP36	1 1	1 unit 1 unit	41B 41B

Solid-state operating mechanism

With 24 V DC control signal input e.g. for control by PLC

With integrated coil circuit (varistor integrated in electronics at the factory)

S10	225	55	110	160	200	330	2	2	96 ... 127 200 ... 277	X X	3RT1264-6NF36 3RT1264-6NP36	1 1	1 unit 1 unit	41B 41B
	265	75	132	160	250	330	2	2	96 ... 127 200 ... 277	X X	3RT1265-6NF36 3RT1265-6NP36	1 1	1 unit 1 unit	41B 41B
	300	90	160	200	250	330	2	2	96 ... 127 200 ... 277	X X	3RT1266-6NF36 3RT1266-6NP36	1 1	1 unit 1 unit	41B 41B
S12	400	132	200	250	400	610	2	2	96 ... 127 200 ... 277	X X	3RT1275-6NF36 3RT1275-6NP36	1 1	1 unit 1 unit	41B 41B
	500	160	250	355	500	610	2	2	96 ... 127 200 ... 277	X X	3RT1276-6NF36 3RT1276-6NP36	1 1	1 unit 1 unit	41B 41B

¹⁾ When using 3RT12.6-6A... vacuum contactors with IE3/IE4 motors from 8.5 times the starting current, use the versions with solid-state operating mechanism 3RT12.6-6N...
For more information about dimensioning and configuring, see page 3/7.

Other voltages according to page 3/74 on request.

For an overview of the 3RT12 vacuum contactors with mountable accessories, see pages 3/14 and 3/16.

The accessories for the 3RT1 vacuum contactors correspond to those for the basic units of the 3RT1 contactors, see page 3/75 onwards.

For spare parts, see page 3/139.

Switching Devices – Contactors and Contactor Assemblies – for Switching Motors

Power Contactors for Switching Motors

SIRIUS 3RT12 and 3TF6 vacuum contactors

3TF6 vacuum contactors, 3-pole, 335 ... 450 kW

AC operation

- For screw fixing
- Main conductors: Busbar connections
- Auxiliary and control conductors: Screw terminals
- With overvoltage protection of the coil (varistor)



3TF68/3TF69

Size	Rated data						AC-1, t_{ij} : 40 °C	Auxiliary contacts, lateral		Rated control supply voltage U_s 50/60 Hz AC	SD	Screw terminals 	PU (UNIT, SET, M)	PS*	PG
	Operational current I_e up to	Rating of three-phase motors at 50 Hz and up to						Operational current I_e up to	NO						
A	kW	kW	kW	kW	kW	A					d				
AC operation, 50/60 Hz¹⁾															
14	630	200	335²⁾	434	600	--	700	4	4	110 ... 132	X	3TF6844-OCF7	1	1 unit	41B
14	820	260	450³⁾	600	800	--	910	4	4	110 ... 132	X	3TF6944-OCF7	1	1 unit	41B
14	820	260	450³⁾	600	800	--	910	4	4	110 ... 132	X	3TF6944-OCF7	1	1 unit	41B
14	820	260	450³⁾	600	800	--	910	4	4	110 ... 132	X	3TF6944-OCF7	1	1 unit	41B

¹⁾ For use of 3TF6 vacuum contactors in the environment of frequency converters, we recommend ordering a special version: **3TF6...-Z A02**.

3TF68/3TF69 vacuum contactors in their basic version are supplied with integrated overvoltage damping for the main current paths. The surge suppression circuit is not required for operation in circuits with DC choppers, frequency converters or speed-variable operating mechanisms, for example.

The circuit could be damaged by the voltage peaks and harmonics and thus cause phase-to-phase short circuits. For this reason, the contactors can also be supplied without integrated overvoltage damping. Without additional price. The article number must be supplemented by "-Z" and the order code "A02".

²⁾ When using 3TF68 vacuum contactors with IE3/IE4 motors from 8.5 times the starting current, please use 3TF69 vacuum contactors. For more information about dimensioning and configuring, see page 3/7.

³⁾ Please inquire about use of 3TF69 vacuum contactors with IE3/IE4 motors.

Accessories and spare parts, see pages 3/137 to 3/140.

Rated control supply voltages, possible on request (change of the 10th and 11th digits of the Article No.)

Delivery time on request

Rated control supply voltage U_s	Contactor type	3TF6844-C... 3TF6944-C...
	Size	14

AC operation

Solenoid coils for 50/60 Hz

110 ... 132 V AC	F7
200 ... 240 V AC	M7
230 ... 277 V AC	P7
380 ... 460 V AC	Q7
500 ... 600 V AC	S7

Switching Devices – Contactors and Contactor Assemblies – for Switching Motors

Power Contactors for Switching Motors

SIRIUS 3RT12 and 3TF6 vacuum contactors **IE3/IE4 ready**

DC operation 

and for AC operation subject to strong interference 

- Main conductors: Busbar connections
- Auxiliary and control conductors: Screw terminals
- DC solenoid system with 3TC44 reversing contactor for series resistor

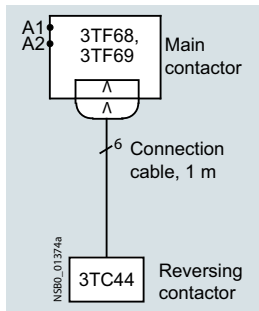

3TF6.33-Q.7

Size	Rated data						AC-1, t_{ij} : 40 °C	Auxiliary contacts, lateral		Rated control supply voltage U_s 50/60 Hz AC or DC	SD	Screw terminals 	PU (UNIT, SET, M)	PS*	PG				
	Operational current I_e up to	Rating of three-phase motors at 50 Hz and						Operational current I_e up to	NO							NC	V	Article No.	Price per PU
690 V	230 V	400 V	500 V	690 V	1 000 V	690 V	A			kW	kW	kW	kW	kW	A				
DC operation · DC economy circuit¹⁾²⁾																			
14	630	200	335 ³⁾	434	600	--	700	3	3	24 DC	20	3TF6833-1DB4	1	1 unit	41B				
						600	700	3	3	24 DC	20	3TF6833-8DB4	1	1 unit	41B				
14	820	260	450 ⁴⁾	600	800	--	910	3	3	24 DC	20	3TF6933-1DB4	1	1 unit	41B				
						800	910	3	3	24 DC	X	3TF6933-8DB4	1	1 unit	41B				
AC operation 50/60 Hz with DC economy circuit²⁾⁵⁾. For AC operation subject to strong interference																			
14	630	200	335 ³⁾	434	600	--	700	3	3	110 ... 120 AC	20	3TF6833-1QG7	1	1 unit	41B				
										220 ... 240 AC	20	3TF6833-1QL7	1	1 unit	41B				
										380 ... 420 AC	20	3TF6833-1QV7	1	1 unit	41B				
						600	700	3	3	220 ... 240 AC	20	3TF6833-8QL7	1	1 unit	41B				
14	820	260	450 ⁴⁾	600	800	--	910	3	3	110 ... 120 AC	20	3TF6933-1QG7	1	1 unit	41B				
										220 ... 240 AC	20	3TF6933-1QL7	1	1 unit	41B				
										380 ... 420 AC	20	3TF6933-1QV7	1	1 unit	41B				
						800	910	3	3	110 ... 120 AC	X	3TF6933-8QG7	1	1 unit	41B				
										220 ... 240 AC	20	3TF6933-8QL7	1	1 unit	41B				

1) On this version, a magnetic system is used in the DC economy circuit. A varistor can be retrofitted. A 3TC4417-4A.. reversing contactor is included in the scope of supply of the vacuum contactor.

2) For use of 3TF6 vacuum contactors in the environment of frequency converters, we recommend ordering a special version: **3TF6...-Z A02**. 3TF68/3TF69 vacuum contactors in their basic version are supplied with integrated overvoltage damping for the main current paths. The surge suppression circuit is not required for operation in circuits with DC choppers, frequency converters or speed-variable operating mechanisms, for example.

The circuit could be damaged by the voltage peaks and harmonics and thus cause phase-to-phase short circuits. For this reason, the contactors can also be supplied without integrated overvoltage damping. Without additional price. The article number must be supplemented by "-Z" and the order code "A02".

3) When using 3TF68 vacuum contactors with IE3/IE4 motors from 8.5 times the starting current, please use 3TF69 vacuum contactors. For more information about dimensioning and configuring, see page 3/7.

4) Please inquire about use of 3TF69 vacuum contactors with IE3/IE4 motors.

5) On this version, a magnetic system with rectifier is used in the DC economy circuit. Varistor integrated. A 3TC4417-.... reversing contactor with preassembled connecting cable (approx. 1 m) and plug is included in the scope of supply of the vacuum contactor.

Accessories and spare parts, see pages 3/137 to 3/140.

Rated control supply voltages, possible on request (change of the 10th and 11th digits of the Article No.)

Delivery time on request

Rated control supply voltage U_s	Contactor type	3TF6833-D... 3TF6933-D..
	Size	14

DC operation

Solenoid coils for DC economy circuit

24 V DC	B4
110 V DC	F4
125 V DC	G4
220 V DC	M4
230 V DC	P4

Switching Devices – Contactors and Contactor Assemblies – for Switching Motors



Power Contactors for Switching Motors

Accessories and spare parts for SIRIUS 3RT12 and 3TF6 vacuum contactors

Selection and ordering data

Accessories

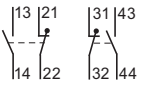
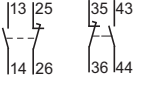
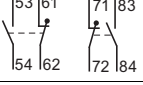

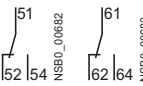

For further accessories for the SIRIUS 3RT12 vacuum contactors, see [3RT1 basic units, page 3/75 onwards](#).

For contactors	Version	Auxiliary contacts			Connections		SD	Screw terminals	⊕	PU (UNIT, SET, M)	PS*	PG	
		Version				Left							Right
Size	Type	NO	NC	NC									
Auxiliary switches, instantaneous													
For lateral mounting													
 3TY7561-1.A00	14	3TF68, 3TF69	First auxiliary switch (replacement for 3TY7561-1A/3TY7561-1B)					▶	3TY7561-1AA00		1	1 unit	41B
			1	1	--								
		3TF68, 3TF69	First auxiliary switch						3TY7561-1EA00		1	1 unit	41B
			1	--	1								
		3TF68, 3TF69	Second auxiliary switch (replacement for 3TY7561-1K/3TY7561-1L)						3TY7561-1KA00		1	1 unit	41B
			1	1	--								
For switchover of the coil with DC economy circuit													
	14	3TF68, 3TF69	--	--	--	1			3TY7681-1G		1	1 unit	41B
Solid-state compatible auxiliary switches													
For lateral mounting													
 5TY7561-1UA00	14	3TF68, 3TF69	Second auxiliary switch, left or right (replacement for 3TY6561-1U/3TY6561-1V)						3TY7561-1UA00		1	1 unit	41B
			1 CO contact										

Switching Devices – Contactors and Contactor Assemblies – for Switching Motors

Power Contactors for Switching Motors

Accessories and spare parts for SIRIUS 3RT12 and 3TF6 vacuum contactors

For contactors	Version	SD	Article No.	Price per PU	PU (UNIT, SET, M)	PS*	PG
Size	Type	d					
Main current path surge suppression modules							
	S10/ S12	3RT12	For damping overvoltages and protecting motor windings against multiple re-ignition when switching off three-phase motors For connection on the contactor feeder side (2-T1/4-T2/6-T3), for separate installation Rated operational voltage U_e				
	3RT1966-1PV3		• 690 V AC • 1 000 V AC	10	3RT1966-1PV3	1	1 unit 41B
				10	3RT1966-1PV4	1	1 unit 41B
3RT1966-1PV4							
Surge suppressors							
	14	3TF68, 3TF69	Varistors <u>AC operation</u> The surge suppressor (varistor) is included in the scope of supply of the 3TF68 and 3TF69 contactors with AC operation. <u>DC operation · DC economy circuit</u> Varistor for snapping onto the side of the auxiliary switch (includes the peak value of the alternating voltage on the DC side) Rated control supply voltage U_s				
	3TX7572-3		• 24 ... 48 V DC • 127 ... 240 V DC	20	3TX7572-3G	1	1 unit 41B
				20	3TX7572-3J	1	1 unit 41B
Terminal covers							
	14		Two units required per contactor (1 set = 2 units).				
	3TF68		For protection against inadvertent contact with exposed busbar connections	5	3TX7686-0A	1	1 unit 41B
	3TF69		Can be screwed onto free screw end on middle connecting bar	5	3TX7696-0A	1	1 unit 41B
3TX7686-0A							
Links for paralleling (star jumpers), 3-pole							
	14	3TF68, 3TF69	Links for paralleling without connecting terminal (the link for paralleling can be reduced by one pole)	5	3TX7680-0D	1	1 unit 41B
	14	3TF68, 3TF69	Cover plates for links for paralleling A cover plate must be used to protect against inadvertent contact with exposed busbar connections (IEC 60529).	15	3TX7680-0E	1	1 unit 41B
Box terminals for laminated copper bars							
	14	3TF68	Without auxiliary conductor connection (1 set = 3 units) With single covers for protection against inadvertent contact (IEC 60529)	30	3TX7570-1E	1	1 unit 41B
	14	3TF69	With auxiliary conductor connection (1 set = 3 units) Conductor cross-sections for auxiliary conductors: • Solid 2 x (0.75 ... 2.5) mm ² • Finely stranded with end sleeve 2 x (0.5 ... 2.5) mm ² • AWG, solid or stranded 2 x (18 ... 12) • Tightening torque 0.8 ... 1.4 Nm (7 ... 12 lb.in)	30	3TX7690-1F	1	1 unit 41B
Locking devices for mechanical interlock							
	14	3TF68	For two contactors of the same size	15	3TX7686-1A	1	1 unit 41B



Switching Devices – Contactors and Contactor Assemblies – for Switching Motors

Power Contactors for Switching Motors

Accessories and spare parts for SIRIUS 3RT12 and 3TF6 vacuum contactors

Spare parts

PU (UNIT, SET, M) = 1
 PS* = 1 unit
 PG = 41B

For contactors		Rated control supply voltage $U_{s \min} \dots U_{s \max}$	SD	Screw terminals	SD	Spring-loaded terminals		
Size	Type	V AC/DC	d	Article No.	Price per PU	Article No.		
Withdrawable coils								
Standard operating mechanism for AC/DC								
	S10	3RT126	23 ... 26	5	3RT1966-5AB31	--		
			42 ... 48	5	3RT1966-5AD31	--		
			110 ... 127	2	3RT1966-5AF31	--		
			200 ... 220	5	3RT1966-5AM31	--		
			220 ... 240	5	3RT1966-5AP31	--		
			240 ... 277	5	3RT1966-5AU31	--		
			380 ... 420	5	3RT1966-5AV31	--		
			440 ... 480	5	3RT1966-5AR31	--		
500 ... 550	5	3RT1966-5AS31	--					
575 ... 600	5	3RT1966-5AT31	--					
	S12	3RT127	23 ... 26	5	3RT1975-5AB31	5 3RT1975-5AB32		
			42 ... 48	5	3RT1975-5AD31	5 3RT1975-5AD32		
			110 ... 127	5	3RT1975-5AF31	5 3RT1975-5AF32		
			200 ... 220	5	3RT1975-5AM31	5 3RT1975-5AM32		
			220 ... 240	5	3RT1975-5AP31	5 3RT1975-5AP32		
			240 ... 277	5	3RT1975-5AU31	5 3RT1975-5AU32		
			380 ... 420	5	3RT1975-5AV31	5 3RT1975-5AV32		
			440 ... 480	5	3RT1975-5AR31	5 3RT1975-5AR32		
500 ... 550	5	3RT1975-5AS31	5 3RT1975-5AS32					
575 ... 600	5	3RT1975-5AT31	5 3RT1975-5AT32					
	S10	3RT126	21 ... 27.3	5	3RT1966-5NB31	--		
			96 ... 127	5	3RT1966-5NF31	--		
			200 ... 277	5	3RT1966-5NP31	--		
			S12	3RT127	21 ... 27.3	5	3RT1975-5NB31	5 3RT1975-5NB32
					96 ... 127	5	3RT1975-5NF31	5 3RT1975-5NF32
					200 ... 277	5	3RT1975-5NP31	5 3RT1975-5NP32

For contactors		Version	SD	Article No.	Price per PU	PU (UNIT, SET, M)	PS*	PG
Size	Type		d					

Solenoid coils

	14	3TF68 3TF69	AC operation¹⁾	5	3TY7683-0C.. 3TY7693-0C..			
			The solenoid coils are fitted as standard with varistors against overvoltage; the coil is supplied with switch-on electronics.					
	14	3TF68 3TF69	DC operation¹⁾ · DC economy circuit	5	3TY7683-0D.. 3TY7693-0D..			
			The solenoid coils are supplied without reversing contactor.					

3TY76.3-0...

Vacuum interrupters

	S10	3RT1264 3RT1265 3RT1266	Set with 3 vacuum interrupters with fixing parts	5	3RT1964-6V	1	1 unit	41B
			5	3RT1965-6V	1	1 unit	41B	
			5	3RT1966-6V	1	1 unit	41B	
	S12	3RT1275 3RT1276	5	3RT1975-6V	1	1 unit	41B	
			5	3RT1976-6V	1	1 unit	41B	
	14	3TF68 3TF69	Set with 3 vacuum interrupters with components	5	3TY7680-0B	1	1 unit	41B
15			3TY7690-0B	1	1 unit	41B		

Note:
 In order to ensure reliable operation of the contactors, only **original replacement interrupters** should be used.

¹⁾ Rated control supply voltages for solenoid coils:
 The 10th and 11th digits of the article number must be supplemented accordingly, see the tables on pages 3/135 and 3/136.

Switching Devices – Contactors and Contactor Assemblies – for Switching Motors

Power Contactors for Switching Motors

Accessories and spare parts for SIRIUS 3RT12 and 3TF6 vacuum contactors

For contactors		Version	Rated control supply voltage U_s	SD	Screw terminals 	PU (UNIT, SET, M)	PS*	PG	
Size	Type		V AC	d	Article No.	Price per PU			
Solenoid coils for main contactor									
14	3TF68...-Q	With rectifier bridge	110 ... 120	20	3TY7683-0QG7		1	1 unit	41B
			220 ... 240	X	3TY7683-0QL7		1	1 unit	41B
			380 ... 420	X	3TY7683-0QV7		1	1 unit	41B
14	3TF69...-Q	With rectifier bridge	110 ... 120	20	3TY7693-0QG7		1	1 unit	41B
			220 ... 240	20	3TY7693-0QL7		1	1 unit	41B
			380 ... 420	X	3TY7693-0QV7		1	1 unit	41B
3TC44 reversing contactors									
14	3TF68...-Q, 3TF69...-Q	Complete with series resistor, 1 m connecting cable and plug-in connector	110 ... 120	20	3TY7684-0QG7		1	1 unit	41B
			220 ... 240	20	3TY7684-0QL7		1	1 unit	41B
			380 ... 420	X	3TY7684-0QV7		1	1 unit	41B

Switching Devices – Contactors and Contactor Assemblies – for Switching Motors

Power Contactors for Switching Motors

3TG10 power relays/miniature contactors

Overview

Standards

IEC 60947-1, IEC 60947-4-1, IEC 60947-5-1

Version

The 3TG10 power relays/miniature contactors are available with screw terminals or 6.3 mm × 0.8 mm flat connectors. The versions with screw terminals are suitable for use in any climate and finger-safe according to IEC 60529.

The 3TG10 miniature contactors are characterized by their width of just 36 mm.

Surge suppression

The 3TG10 power relays/miniature contactors have an integrated protective circuit against opening surges.

Application

Because they are hum-free they are suitable for use in household appliances and distribution boards in office and residential areas.

They can also be used for applications where there is little space, such as air conditioners, heating systems, pumps and fans, i.e. for simple electrical controls.

Technical specifications

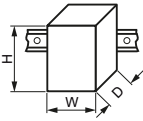
More information	
Technical specifications, see https://support.industry.siemens.com/cs/ww/en/ps/16186/td	Reference Manual "Switching Devices – Contactors and Contactor Assemblies", see https://support.industry.siemens.com/cs/ww/en/view/35554359 FAQs, see https://support.industry.siemens.com/cs/ww/en/ps/16186/faq
Type	3TG10
General data	
Dimensions (W x H x D)	mm 36 x 56 x 56
	
Endurance	
• Mechanical	Operating cycles 3 million
• Electrical	
- AC-1 at I_e	Operating cycles 0.1 million
- AC-3 at I_e	Operating cycles 0.4 million
Rated insulation voltage U_i (pollution degree 3)	V 400
Rated impulse withstand voltage U_{imp}	kV 4
Protective separation	
Between the coil and the contacts acc. to IEC 60947-1, Appendix N	V Up to 300
Permissible ambient temperature	
• During operation ¹⁾	°C -25 ... + 55
• During storage	°C -50 ... + 80
Degree of protection acc. to IEC 60529	IP00
Touch protection acc. to IEC 60529	Finger-safe for vertical touching from the front (with screw terminals)
Short-circuit protection	
Fuse links , operational class gG: LV HRC, type 3NA; DIAZED, type 5SB; NEOZED, type 5SE according to IEC 60947-4-1	
• Type of coordination "1"	A 25
• Type of coordination "2"	A 10
Miniature circuit breakers , C characteristic	A 10
Control	
Solenoid coil operating range	0.85 ... 1.1 × U_s
Power consumption of the solenoid coils (for cold coil and 1.0 × U_s)	
• AC operation, 45 ... 450 Hz	VA 4.4
- P.f.	0.9 (hum-free)
• DC operation	W 4
Rated data of the main contacts	
Load rating with AC	
Utilization category AC-1, switching resistive loads	
• Rated operational current I_e up to 400 V at 55 °C ¹⁾	A 20 for screw terminals, 16 for flat connectors
• Rated power U_e for AC loads with p.f. = 1, 230/220 V	
- For screw terminals	kW 7.5 (13 at 400 V)
- For flat connectors	kW 6 (10 at 400 V)
• Minimum conductor cross-section for loads with I_e	mm ² 2.5

¹⁾ If the three main current paths carry a load of 20 A, the following applies if $I > 10$ A in the fourth current path: Permissible ambient temperature 40 °C.

Switching Devices – Contactors and Contactor Assemblies – for Switching Motors

Power Contactors for Switching Motors



3TG10 power relays/miniature contactors

Type	3TG10				
Rated data of the main contacts (continued)					
Load rating with AC					
Utilization categories AC-2 and AC-3					
• Operational current for AC-3 at $U_e \leq 400$ V rated value			A	8.4	
• Rated power for slipping or squirrel-cage motors with 50 and 60 Hz and at $U_e \leq 400$ V			kW	4	
Utilization category AC-5a (permissible nominal impedance: $\geq 0.5 \Omega$)					
Switching of gas discharge lamps					
Per main current path at 230 V, 50 Hz					
Rated power/rated operational current per lamp					
• Uncompensated	18 W	0.37 A	Unit(s)	43	
	36 W	0.43 A	Unit(s)	37	
	58 W	0.67 A	Unit(s)	24	
• DUO switching	18 W	2 x 0.11 A	Unit(s)	2 x 81	
	36 W	2 x 0.21 A	Unit(s)	2 x 42	
	58 W	2 x 0.32 A	Unit(s)	2 x 28	
Switching of gas discharge lamps with compensation or ECG					
Per main current path 230 V, 50 Hz					
Connection	Rated power per lamp	Capacitor capacitance	Rated operational current per lamp		
• Shunt compensation	L18 W	4.5 μ F	0.11 A	Unit(s) 15	
	L36 W	4.5 μ F	0.21 A	Unit(s) 15	
	L58 W	7 μ F	0.32 A	Unit(s) 10	
• With ECG (single lamp)	L18 W	6.8 μ F	0.10 A	Unit(s) 39	
	L36 W	6.8 μ F	0.18 A	Unit(s) 39	
	L58 W	10 μ F	0.27 A	Unit(s) 26	
• With ECG (two lamps)	L18 W	10 μ F	0.18 A	Unit(s) 2 x 26	
	L36 W	10 μ F	0.35 A	Unit(s) 2 x 26	
	L58 W	22 μ F	0.52 A	Unit(s) 2 x 12	
Utilization category AC-5b, switching incandescent lamps				kW	1.6
Per main current path at 230 V, 50 Hz					
Load rating with DC					
Utilization category DC-1, switching resistive loads ($L/R \leq 15$ ms)					
• Rated operational currents I_e					
- 1 conducting path			Up to 24 V	A 16	
			60 V	A 6	
			110 V	A 2	
			220 V/240 V	A 0.8	
- 2 conducting paths in series			Up to 24 V	A 16	
			60 V	A 16	
			110 V	A 6	
			220 V/240 V	A 1.6	
- 3 conducting paths in series			Up to 24 V	A 18	
			60 V	A 18	
			110 V	A 16	
			220 V/240 V	A 6	
- 4 conducting paths in series			Up to 24 V	A 20	
			60 V	A 20	
			110 V	A 20	
			220 V/240 V	A 20	
Utilization category DC-3 and DC-5					
Shunt-wound and series-wound motors ($L/R \leq 15$ ms)					
• Rated operational currents I_e					
- 1 conducting path			Up to 24 V	A 10	
			60 V	A 0.5	
			110 V	A 0.15	
			220 V/240 V	A 0	
- 2 conducting paths in series			Up to 24 V	A 16	
			60 V	A 5	
			110 V	A 0.35	
			220 V/240 V	A 0	
- 3 conducting paths in series			Up to 24 V	A 16	
			60 V	A 16	
			110 V	A 10	
			220 V/240 V	A 1.75	
- 4 conducting paths in series			Up to 24 V	A 18	
			60 V	A 16	
			110 V	A 10	
			220 V/240 V	A 2	

Switching Devices – Contactors and Contactor Assemblies – for Switching Motors

Power Contactors for Switching Motors

3TG10 power relays/miniature contactors

Type	3TG10	
Conductor cross-sections		
		 Screw terminals
<ul style="list-style-type: none"> Terminal screws Finely stranded with end sleeve (DIN 46228 Form A/D/C) Solid Permissible opening tool (screwdriver) 	mm ² mm ²	M3 2 x (0.75 ... 2.5) 2 x (1 ... 2.5), 1 x 4 3.0 mm x 0.5 mm (3RA2908-1A) or Pozidriv 2
		 Flat connectors
<ul style="list-style-type: none"> Finely stranded 6.3 mm plug-in sleeve acc. to DIN 46245/DIN 46247 - 6.3 ... 1 - 6.3 ... 2.5 	mm ² mm ²	0.5 ... 1 1 ... 2.5
Ⓢ and Ⓣ rating (screw terminals)		
Rated insulation voltage	V AC	600
Uninterrupted current Open and enclosed	A	20
Maximum horsepower ratings (from Ⓢ and Ⓣ approved values)	Single-phase/three-phase	
<ul style="list-style-type: none"> Rated power for three-phase motors at 60 Hz 	At 115 V hp 200 V hp 230 V hp 460 ... 600 V hp	0.5/ -- 1/ 3 1.5/ 3 0/ 5

Switching Devices – Contactors and Contactor Assemblies – for Switching Motors

Power Contactors for Switching Motors

3TG10 power relays/miniature contactors

Selection and ordering data

AC operation or DC operation

For screw fixing and snap-on mounting onto TH 35 standard mounting rail

Rated data		Utilization category		Auxiliary contacts	Rated control supply voltage U_s	SD	Article No.	Price per PU	PU (UNIT, SET, M)	PS*	PG
Operational current I_e up to 400 V	Power of AC loads at 50 Hz and 400 V	Operational current I_e up to 400 V ¹⁾	Power of AC loads at 50 Hz and 400 V	Version							
A	kW	A	kW	NO NC	V	d					

Hum-free · with screw terminals

Screw terminals



AC operation, 45 ... 450 Hz

20	13	8.4	4	1	--	24 AC	▶	3TG1010-0AC2	1	1 unit	41H
						110 AC	5	3TG1010-0AG2	1	1 unit	41H
						230 AC	▶	3TG1010-0AL2	1	1 unit	41H
				--	1	24 AC	▶	3TG1001-0AC2	1	1 unit	41H
						110 AC	5	3TG1001-0AG2	1	1 unit	41H
						230 AC	▶	3TG1001-0AL2	1	1 unit	41H

3TG10..-0...

DC operation

20	13	8.4	4	1	--	24 DC	▶	3TG1010-0BB4	1	1 unit	41H
				--	1	24 DC	▶	3TG1001-0BB4	1	1 unit	41H

Hum-free · with 6.3 mm x 0.8 mm flat connectors

Flat connectors



AC operation, 45 ... 450 Hz

16	10	8.4	4	1	--	24 AC	5	3TG1010-1AC2	1	1 unit	41H
						110 AC	30	3TG1010-1AG2	1	1 unit	41H
						230 AC	5	3TG1010-1AL2	1	1 unit	41H
				--	1	24 AC	30	3TG1001-1AC2	1	1 unit	41H
						110 AC	30	3TG1001-1AG2	1	1 unit	41H
						230 AC	▶	3TG1001-1AL2	1	1 unit	41H

3TG10..-1...

DC operation

16	10	8.4	4	1	--	24 DC	5	3TG1010-1BB4	1	1 unit	41H
		8.4	4	--	1	24 DC	5	3TG1001-1BB4	1	1 unit	41H

¹⁾ The rated operational currents apply to each pole.

Accessories

Version	Max. rated operational currents I_e /AC-1 (at 55 °C) of the contactors	Max. conductor cross-sections	SD	Screw terminals 	PU (UNIT, SET, M)	PS*	PG
A		mm ²	d	Article No.	Price per PU		

Links for paralleling (insulated star jumpers)¹⁾



3-pole

• Without connection terminal (replacement for 3TX4490-2C)	16	--	▶	3RT1916-4BA31	1	1 unit	41B
• With connection terminal (replacement for 3TX4490-2A)	40	25	▶	3RT1916-4BB31	1	1 unit	41B

3RT1916-4BB31

4-pole

• With connection terminal (replacement for 3TX4490-2B)	40	25	15	3RT1916-4BB41	1	1 unit	41B
---	----	----	----	----------------------	---	--------	-----

¹⁾ The links for paralleling can be reduced by one pole. The rated operational currents apply to each pole.

Switching Devices – Contactors and Contactor Assemblies – for Switching Motors

Reversing Contactor Assemblies

SIRIUS 3RA23 reversing contactor assemblies, up to 55 kW

Overview

More information

Homepage, see www.siemens.com/sirius

Industry Mall, see www.siemens.com/product?3RA23_3RT1

Conversion tool for article numbers, see www.siemens.com/sirius/conversion-tool

TIA Selection Tool Cloud (TST Cloud), see <https://www.siemens.com/tstcloud/?node=LoadFeeder>

The 3RA23 reversing contactor assemblies in sizes S00 to S3 can be ordered as follows:

- Fully wired and tested, with mechanical and electrical interlock, see [page 3/152 onwards](#).
- For all individual parts for customer assembly, see [page 3/75 onwards](#).

The 3RA23 reversing contactor assemblies have screw or spring-loaded terminals (main and control circuits) and are suitable for screw fixing and snap-on mounting onto TH 35 standard mounting rails.

Complete 3RA23 reversing contactor assemblies

The fully wired reversing contactor assemblies are suitable for use in any climate.

They are finger-safe according to IEC 60529.

The 3RA23 reversing contactor assemblies of size S00 to S3 each consist of two contactors with the same power, with one NC contact (S00) or one NO contact and one NC contact (S0 to S3) in the basic unit. The contactors are mechanically and electrically interlocked (NC contact interlock).

3RU2 overload relays (see [page 7/92 onwards](#)) or 3RB3 overload relays (see [page 7/105 onwards](#)) for contactor mounting or stand-alone installation, SIMOCODE pro 3UF7 motor management and control devices ([page 10/16 onwards](#)) or 3RN thermistor motor protection relays ([page 10/155](#)) can be used for motor protection.

3RA23 reversing contactor assemblies with voltage tap-off

The reversing contactor assemblies with voltage tap-off (see [pages 3/152 to 3/155](#)) are required for mounting the function modules for connection to the controller via the IO-Link or AS-Interface communication systems. The 3RA27 function modules must be ordered separately, see [page 3/106](#).

For more information on IO-Link and AS-Interface, see "Industrial Communication", [page 2/1 onwards](#).

Switching Devices – Contactors and Contactor Assemblies – for Switching Motors

Reversing Contactor Assemblies

SIRIUS 3RA23 reversing contactor assemblies, up to 55 kW

Sizes S00 to S3

Rated data AC-2 and AC-3 at 50 Hz 400 V AC		Size	Type	Contactor (See page 3/54 onwards)	Assembly kit (See page 3/109)	Fully wired and tested reversing contactor assemblies
Rating kW	Operational current I_e A					
⊕ Screw terminals						
3	7	S00		3RT2015-1...2	3RA2913-2AA1	3RA2315-8XB30-1...
4	9			3RT2016-1...2	3RA2913-2AA1	3RA2316-8XB30-1...
5.5	12			3RT2017-1...2	3RA2913-2AA1	3RA2317-8XB30-1...
7.5	16			3RT2018-1...2	3RA2913-2AA1	3RA2318-8XB30-1...
5.5	12	S0		3RT2024-1...0	3RA2923-2AA1	3RA2324-8XB30-1...
7.5	16			3RT2025-1...0	3RA2923-2AA1	3RA2325-8XB30-1...
11	25			3RT2026-1...0	3RA2923-2AA1	3RA2326-8XB30-1...
15	32			3RT2027-1...0	3RA2923-2AA1	3RA2327-8XB30-1...
18.5	38			3RT2028-1...0	3RA2923-2AA1	3RA2328-8XB30-1...
18.5	40	S2		3RT2035-1...0	3RA2933-2AA1	3RA2335-8XB30-1...
22	55			3RT2036-1...0	3RA2933-2AA1	3RA2336-8XB30-1...
30	65			3RT2037-1...0	3RA2933-2AA1	3RA2337-8XB30-1...
37	80			3RT2038-1...0	3RA2933-2AA1	3RA2338-8XB30-1...
37	80	S3		3RT2045-1...0	3RA2943-2AA1	3RA2345-8XB30-1...
45	90			3RT2046-1...0	3RA2943-2AA1	3RA2346-8XB30-1...
55	110			3RT2047-1...0	3RA2943-2AA1	3RA2347-8XB30-1...
⊕ Spring-loaded terminals						
3	7	S00		3RT2015-2...2	3RA2913-2AA2	3RA2315-8XB30-2...
4	9			3RT2016-2...2	3RA2913-2AA2	3RA2316-8XB30-2...
5.5	12			3RT2017-2...2	3RA2913-2AA2	3RA2317-8XB30-2...
7.5	16			3RT2018-2...2	3RA2913-2AA2	3RA2318-8XB30-2...
5.5	12	S0		3RT2024-2...0	3RA2923-2AA2	3RA2324-8XB30-2...
7.5	16			3RT2025-2...0	3RA2923-2AA2	3RA2325-8XB30-2...
11	25			3RT2026-2...0	3RA2923-2AA2	3RA2326-8XB30-2...
15	32			3RT2027-2...0	3RA2923-2AA2	3RA2327-8XB30-2...
18.5	38			3RT2028-2...0	3RA2923-2AA2	3RA2328-8XB30-2...

Note:

The 3RA2934-2B mechanical interlock for sizes S2 and S3 must be ordered separately, see page 3/113.

Article No. scheme

Product versions	Article number
SIRIUS reversing contactor assembly	3RA23 <input type="checkbox"/> <input type="checkbox"/> - <input type="checkbox"/> <input type="checkbox"/> <input type="checkbox"/> <input type="checkbox"/> - <input type="checkbox"/> <input type="checkbox"/> <input type="checkbox"/> <input type="checkbox"/>
Size of the contactor e.g. 4 = S3	<input type="checkbox"/>
Rating dependent on size e.g. 5 = 37 kW for size S3	<input type="checkbox"/>
Type of overload relay e.g. 8X = Without	<input type="checkbox"/> <input type="checkbox"/>
Assembly e.g. E = Communication-capable installation	<input type="checkbox"/>
Interlock e.g. 3 = Mechanical and electrical	<input type="checkbox"/>
Free auxiliary switches e.g. 0 = S3: 2 NO total	<input type="checkbox"/>
Type of electrical connection e.g. 1 = Screw terminals (main and auxiliary circuits)	<input type="checkbox"/>
Operating range/solenoid coil circuit e.g. A = AC standard/without coil circuit	<input type="checkbox"/>
Rated control supply voltage e.g. L2 = 230 V AC, 50/60 Hz	<input type="checkbox"/> <input type="checkbox"/>
Example	3RA23 4 5 - 8 X E 3 0 - 1 A L 2

Note:

The Article No. scheme shows an overview of product versions for better understanding of the logic behind the article numbers.

For your orders, please use the article numbers quoted in the selection and ordering data.

Switching Devices – Contactors and Contactor Assemblies – for Switching Motors

Reversing Contactor Assemblies

SIRIUS 3RA23 reversing contactor assemblies, up to 55 kW

Fully wired and tested reversing contactor assemblies · Size S00 · Up to 7.5 kW

The figure shows the version with screw terminals

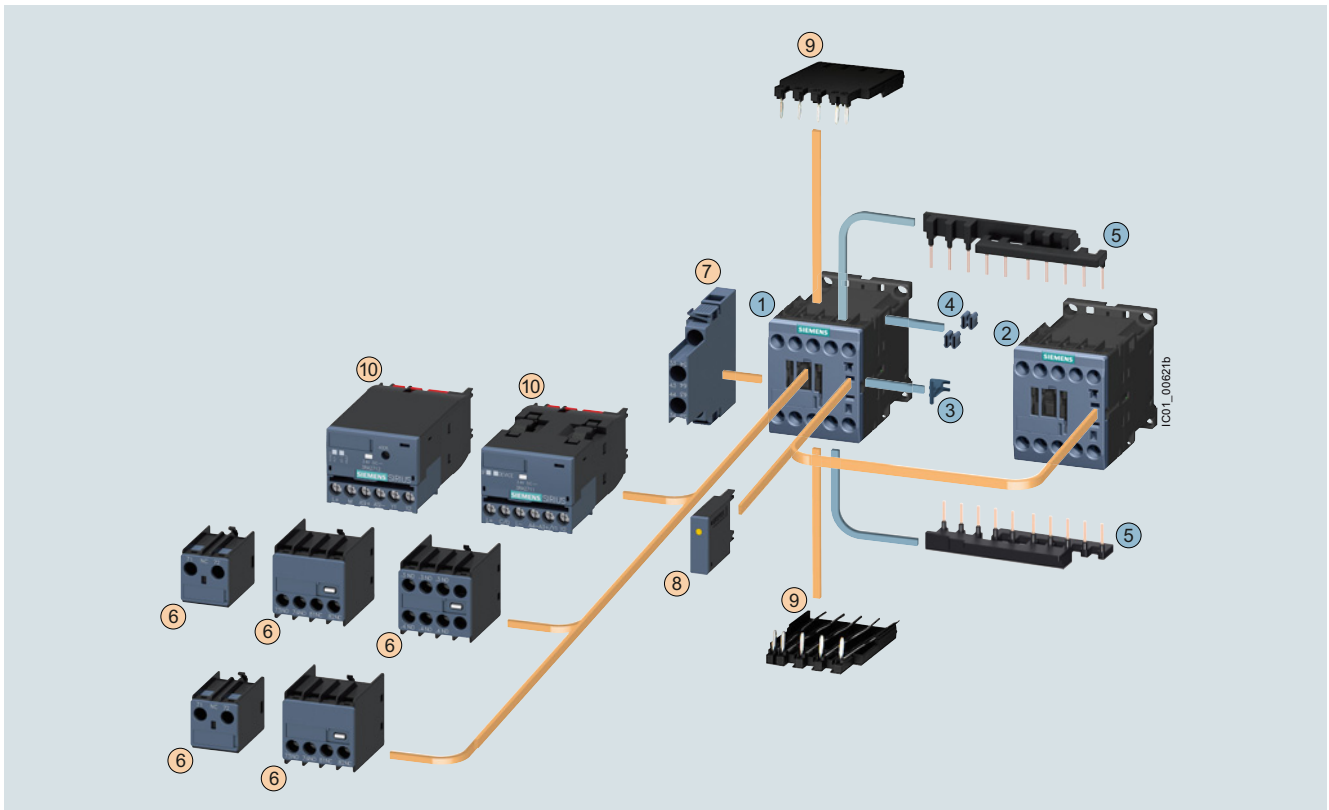

Mountable accessories (optional)

To be ordered separately	Type	Page
⑥ Auxiliary switch, front ¹⁾	3RH2911	3/93 ... 3/95
⑦ Auxiliary switch, lateral	3RH2921	3/97
⑧ Surge suppressors	3RT2916	3/102, 3/103
⑨ Solder pin adapters	3RT1916-4KA1	3/116
⑩ Function module for connection to the control system	3RA271.-1BA00	3/106

Complete reversing contactor assembly

Individual parts	Type	Q11	Q12	Page
① ② Contactors, 3 kW	3RT2015	3RT2015		3/54, 3/61
① ② Contactors, 4 kW	3RT2016	3RT2016		3/54, 3/61
① ② Contactors, 5.5 kW	3RT2017	3RT2017		3/54, 3/61
① ② Contactors, 7.5 kW	3RT2018	3RT2018		3/54, 3/61
③ ... ⑤ Assembly kit comprising:	3RA2913-2AA1			3/109
③ Mechanical interlock ²⁾				
④ Two connecting clips for two contactors ²⁾				
⑤ Wiring modules on the top and bottom for connecting the main current paths, electrical interlock included ³⁾ , interruptible (NC contact interlock)				

¹⁾ Auxiliary switch according to EN 50005 must be used.

²⁾ The parts ③ and ④ can only be ordered together as 3RA2912-2H mechanical connectors.

³⁾ 3RT201. contactors with one NC contact in the basic unit are required for the electrical interlock. An additional NO contact is required for momentary-contact operation.

For complete reversing contactor assemblies, see page 3/152.

Switching Devices – Contactors and Contactor Assemblies – for Switching Motors

Reversing Contactor Assemblies

SIRIUS 3RA23 reversing contactor assemblies, up to 55 kW

Fully wired and tested reversing contactor assemblies · Size S0 · Up to 18.5 kW

The figure shows the version with screw terminals

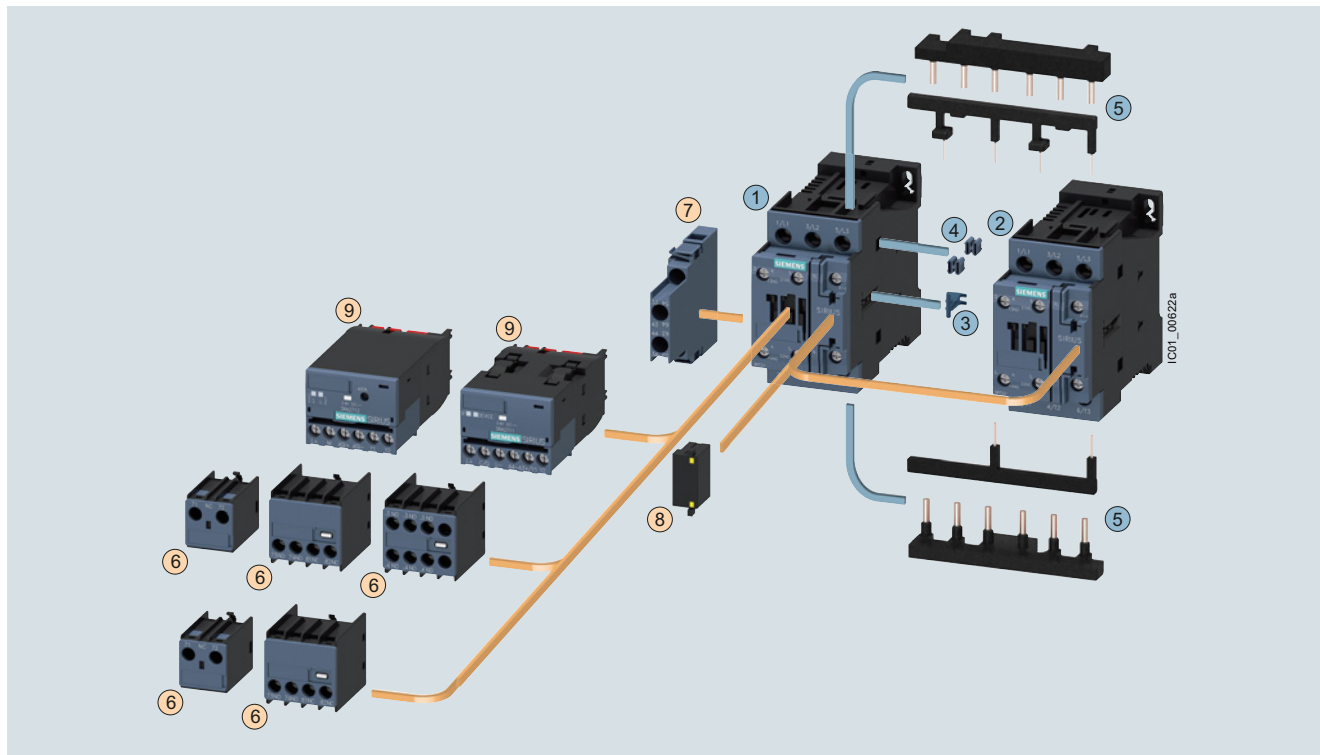

Mountable accessories (optional)

To be ordered separately	Type	Page
⑥ Auxiliary switch, front	3RH2911	3/93 ... 3/95
⑦ Auxiliary switch, lateral	3RH2921	3/97
⑧ Surge suppressors	3RT2926	3/102, 3/103
⑨ Function module for connection to the control system	3RA271.-1BA00	3/106

Complete reversing contactor assembly

Individual parts	Type		Page
	Q11	Q12	
①② Contactors, 5.5 kW	3RT2024	3RT2024	3/55, 3/65
①② Contactors, 7.5 kW	3RT2025	3RT2025	3/55, 3/65
①② Contactors, 11 kW	3RT2026	3RT2026	3/55, 3/65
①② Contactors, 15 kW	3RT2027	3RT2027	3/55, 3/65
①② Contactors, 18.5 kW	3RT2028	3RT2028	3/55, 3/65
③ ... ⑤ Assembly kit comprising:	3RA2923-2AA1		3/109
	③ Mechanical interlock ¹⁾		
	④ Two connecting clips for two contactors ¹⁾		
	⑤ Wiring modules on the top and bottom for connecting the main current paths, electrical interlock included (NC contact interlock)		

¹⁾ The parts ③ and ④ can only be ordered together as 3RA2922-2H mechanical connectors.

For complete reversing contactor assemblies, see page 3/153.

Switching Devices – Contactors and Contactor Assemblies – for Switching Motors

Reversing Contactor Assemblies

SIRIUS 3RA23 reversing contactor assemblies, up to 55 kW

Fully wired and tested reversing contactor assemblies · Size S2 · Up to 37 kW

The figure shows the version with screw terminals

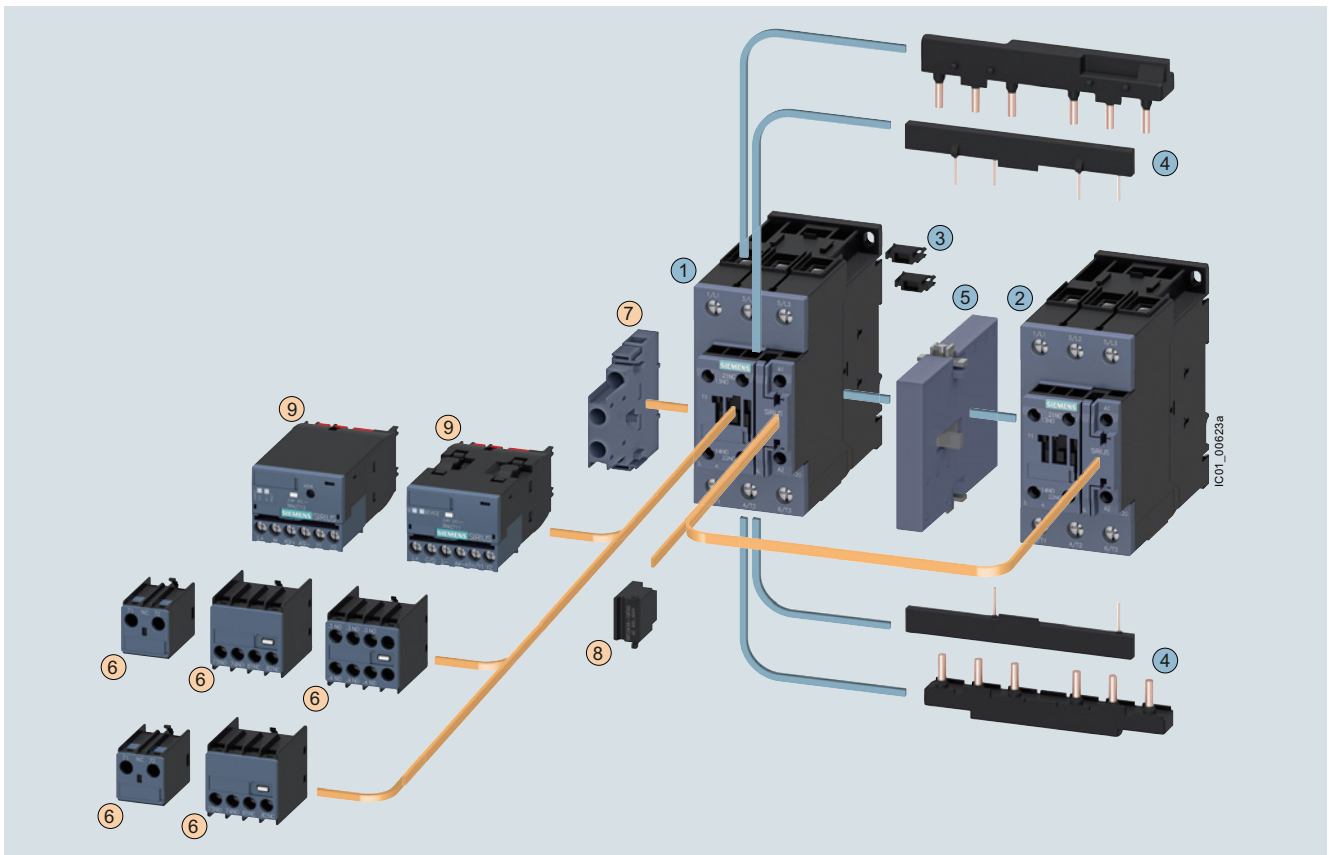

Mountable accessories (optional)

To be ordered separately	Type	Page
⑥ Auxiliary switch, front	3RH2911	3/93 ... 3/95
⑦ Auxiliary switch, lateral	3RH2921	3/97
⑧ Surge suppressors	3RT2936	3/102, 3/103
⑨ Function module for connection to the control system	3RA271.-1BA00	3/106

Complete reversing contactor assembly

Individual parts	Type		Page
	Q11	Q12	
①② Contactors, 18.5 kW	3RT2035	3RT2035	3/57, 3/66
①② Contactors, 22 kW	3RT2036	3RT2036	3/57, 3/66
①② Contactors, 30 kW	3RT2037	3RT2037	3/57, 3/66
①② Contactors, 37 kW	3RT2038	3RT2038	3/57, 3/66
③④ Assembly kit comprising:	3RA2933-2AA1		3/109
③ Two connectors for two contactors			
④ Wiring modules on the top and bottom for connecting the main and auxiliary circuits, electrical interlock included (NC contact interlock)			
⑤ Mechanical interlock (must be ordered separately)	3RA2934-2B		3/113

For complete reversing contactor assemblies, see page 3/154.

Switching Devices – Contactors and Contactor Assemblies – for Switching Motors

Reversing Contactor Assemblies

SIRIUS 3RA23 reversing contactor assemblies, up to 55 kW

Fully wired and tested reversing contactor assemblies · Size S3 · Up to 55 kW

The figure shows the version with screw terminals

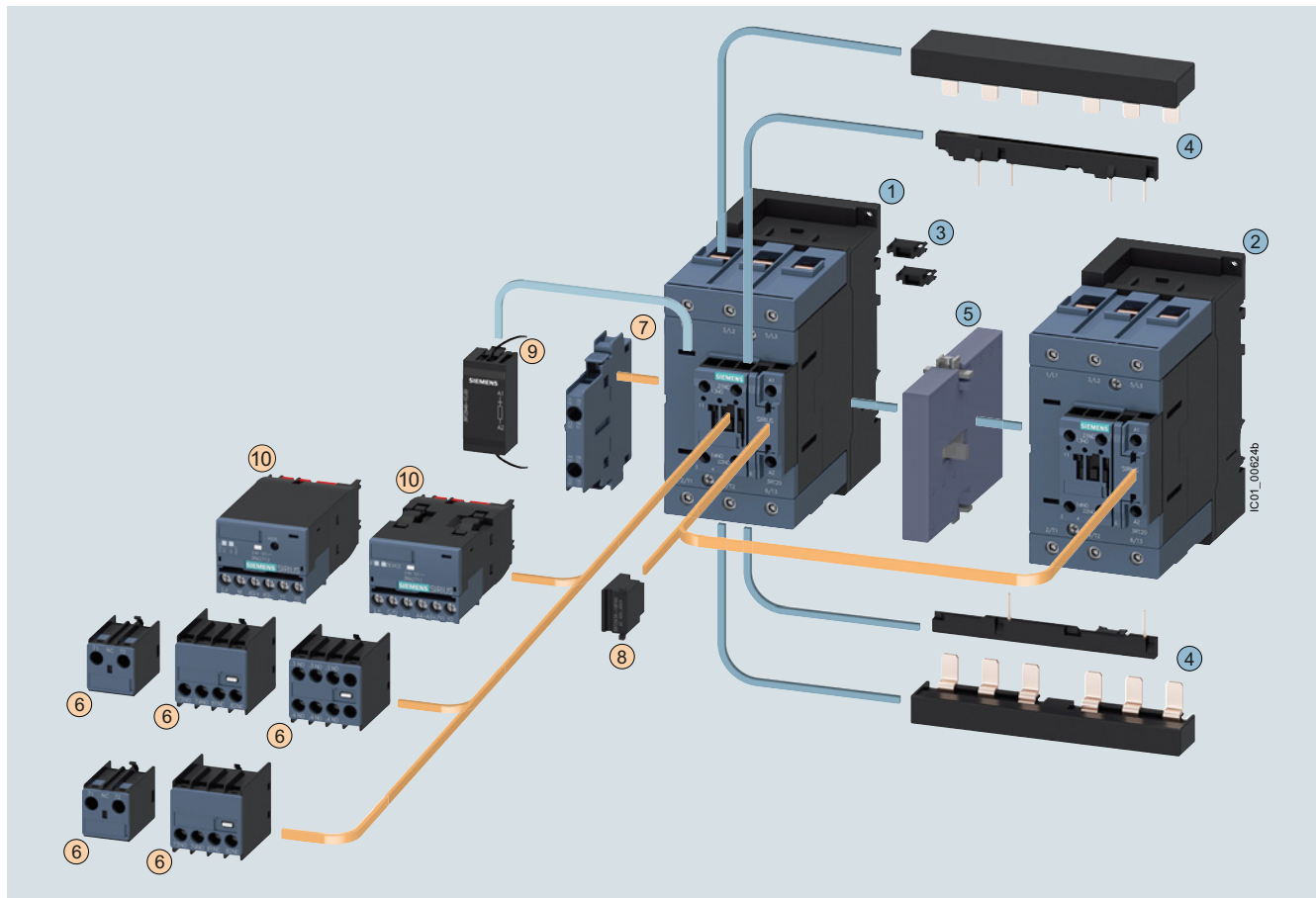

Mountable accessories (optional)

To be ordered separately	Type	Page
⑥ Auxiliary switch, front	3RH2911	3/93 ... 3/95
⑦ Auxiliary switch, lateral	3RH2921	3/97
⑧ Surge suppressor (varistor, diode assembly)	3RT2936 ¹⁾	3/102, 3/103
⑨ Surge suppressor (RC element)	3RT2946	3/102
⑩ Function module for connection to the control system (the associated module connectors 3RA2711-0EE17 must be ordered separately, see page 3/107)	3RA271.-1BA00	3/106

Complete reversing contactor assembly

Individual parts	Type		Page
	Q11	Q12	
①② Contactors, 37 kW	3RT2045	3RT2045	3/58, 3/66
①② Contactors, 45 kW	3RT2046	3RT2046	3/58, 3/66
①② Contactors, 55 kW	3RT2047	3RT2047	3/58, 3/66
③④ Assembly kit comprising:	3RA2943-2AA1		3/109
③ Two connectors for two contactors			
④ Wiring modules on the top and bottom for connecting the main and auxiliary circuits, electrical interlock included (NC contact interlock)			
⑤ Mechanical interlock (must be ordered separately)	3RA2934-2B		3/113

¹⁾ From product version E03 onwards, 3RT2936-1B/-1E surge suppressors can be used for 3RT2.4 contactors.

For complete reversing contactor assemblies, see page 3/155.

Switching Devices – Contactors and Contactor Assemblies – for Switching Motors

Reversing Contactor Assemblies

SIRIUS 3RA23 reversing contactor assemblies, up to 55 kW

Benefits

Using wiring kits for reversing contactor assemblies has the following advantages:

- Notable reduction of wiring in the control circuit
- Integrated mechanical interlock for sizes S00 and S0
- Prevention of wiring errors in the main circuit

Connecting combs for screw terminals also result in:

- Prevention of wiring errors in the control circuit
- Reduction of testing costs
- Ready-jumpered actuation of the auxiliary switches and the frame (A2)
- Integrated electrical interlocking

Accessories

Selecting the auxiliary switches

The following points should be noted:

Size S00

- For maintained-contact operation:
Use contactors with an NC contact in the basic unit for the electrical interlock.
- For momentary-contact operation:
Use contactors with an NC contact in the basic unit for the electrical interlock; in addition, an auxiliary switch with at least one NO contact for latching is required per contactor.

Sizes S0 to S3

- For maintained-contact operation:
The contactors have two integrated auxiliary contacts (1 NO + 1 NC); the NC contact can be used for electrical interlocking.
- For momentary-contact operation:
Electrical interlock as for maintained-contact operation; the NO contact in the basic unit can be used for the latching.

Surge suppression

Sizes S00 to S3

All reversing contactor assemblies can be fitted with RC elements or varistors for damping opening surges in the coil.

As with the individual contactors, the surge suppressors can either be plugged onto the top of the contactors (S00) or be plugged into the front of the contactors (S0 to S3).

Technical specifications

More information

Technical specifications, [see https://support.industry.siemens.com/cs/ww/en/ps/16146/td](https://support.industry.siemens.com/cs/ww/en/ps/16146/td)
FAQs, [see https://support.industry.siemens.com/cs/ww/en/ps/16146/faq](https://support.industry.siemens.com/cs/ww/en/ps/16146/faq)

System Manual "SIRIUS – System Overview", [see https://support.industry.siemens.com/cs/ww/en/view/60311318](https://support.industry.siemens.com/cs/ww/en/view/60311318)
Equipment Manual "SIRIUS – SIRIUS 3RT Contactors/Contactor Assemblies", [see https://support.industry.siemens.com/cs/ww/en/view/60306557](https://support.industry.siemens.com/cs/ww/en/view/60306557)
Application Manual "SIRIUS Controls with IE3/IE4 motors", [see https://support.industry.siemens.com/cs/ww/en/view/94770820](https://support.industry.siemens.com/cs/ww/en/view/94770820)

The technical specifications are the same as for the individual contactors ([see page 3/22 onwards](#)).

Switching Devices – Contactors and Contactor Assemblies – for Switching Motors

Reversing Contactor Assemblies

SIRIUS 3RA23 reversing contactor assemblies, up to 55 kW **IE3/IE4 ready**

Selection and ordering data

Fully wired and tested reversing contactor assemblies¹⁾ · Size S00 · Up to 7.5 kW
AC operation  **or DC operation** 

 PU (UNIT, SET, M) = 1
 PS* = 1 unit
 PG = 41B



3RA231.-8XB30-1A.0



3RA231.-8XE30-1BB4



3RA231.-8XB30-2A.0

Rated data AC-2 and AC-3				Rated control supply voltage U_s	SD	Screw terminals 		SD	Spring-loaded terminals 	
Operational current I_e up to 400 V	Rating of three-phase motors at 50 Hz and					Article No.	Price per PU		Article No.	Price per PU
	A	230 V	400 V	690 V	V			d		
AC operation, 50/60 Hz										
7	2.2	3	4	24 AC	5	3RA2315-8XB30-1AB0	5	3RA2315-8XB30-2AB0		
				110 AC	5	3RA2315-8XB30-1AF0	5	3RA2315-8XB30-2AF0		
				230 AC	2	3RA2315-8XB30-1AP0	2	3RA2315-8XB30-2AP0		
9	3	4	5.5	24 AC	5	3RA2316-8XB30-1AB0	5	3RA2316-8XB30-2AB0		
				110 AC	5	3RA2316-8XB30-1AF0	5	3RA2316-8XB30-2AF0		
				230 AC	2	3RA2316-8XB30-1AP0	2	3RA2316-8XB30-2AP0		
12	3	5.5	5.5	24 AC	5	3RA2317-8XB30-1AB0	5	3RA2317-8XB30-2AB0		
				110 AC	5	3RA2317-8XB30-1AF0	5	3RA2317-8XB30-2AF0		
				230 AC	2	3RA2317-8XB30-1AP0	2	3RA2317-8XB30-2AP0		
16	4	7.5	7.5	24 AC	5	3RA2318-8XB30-1AB0	5	3RA2318-8XB30-2AB0		
				110 AC	5	3RA2318-8XB30-1AF0	5	3RA2318-8XB30-2AF0		
				230 AC	2	3RA2318-8XB30-1AP0	2	3RA2318-8XB30-2AP0		
DC operation										
7	2.2	3	4	24 DC	2	3RA2315-8XB30-1BB4	2	3RA2315-8XB30-2BB4		
9	3	4	5.5	24 DC	2	3RA2316-8XB30-1BB4	2	3RA2316-8XB30-2BB4		
12	3	5.5	5.5	24 DC	2	3RA2317-8XB30-1BB4	2	3RA2317-8XB30-2BB4		
16	4	7.5	7.5	24 DC	2	3RA2318-8XB30-1BB4	2	3RA2318-8XB30-2BB4		
With voltage tap-off										
7	2.2	3	4	24 DC	2	3RA2315-8XE30-1BB4	5	3RA2315-8XE30-2BB4		
9	3	4	5.5	24 DC	2	3RA2316-8XE30-1BB4	5	3RA2316-8XE30-2BB4		
12	3	5.5	5.5	24 DC	2	3RA2317-8XE30-1BB4	2	3RA2317-8XE30-2BB4		
16	4	7.5	7.5	24 DC	2	3RA2318-8XE30-1BB4	2	3RA2318-8XE30-2BB4		

¹⁾ The contactors integrated in the reversing contactor assemblies have no unassigned auxiliary contacts. When used with a voltage tap-off and function module, the auxiliary contacts are unassigned.

Representation of the complete reversing contactor assemblies with optionally mountable accessories, [see page 3/147](#).

Switching Devices – Contactors and Contactor Assemblies – for Switching Motors

Reversing Contactor Assemblies

IE3/IE4 ready SIRIUS 3RA23 reversing contactor assemblies, up to 55 kW

Fully wired and tested reversing contactor assemblies · Size S0 · Up to 18.5 kW
AC operation  **or DC operation** 

 PU (UNIT, SET, M) = 1
 PS* = 1 unit
 PG = 41B



3RA232-8XB30-1A.2

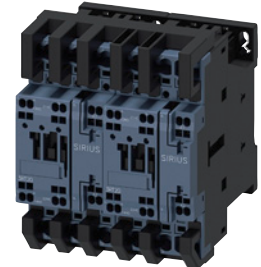

3RA2324-8XE30-1BB4



3RA232-8XB30-2A.2

Rated data AC-2 and AC-3				Rated control supply voltage U_s	SD	Screw terminals 		SD	Spring-loaded terminals 		
Operational current I_e up to 400 V	Rating of three-phase motors at 50 Hz and					Article No.	Price per PU		Article No.	Price per PU	
	A	230 V	400 V	690 V	kW			kW			kW
AC operation, 50/60 Hz											
12	3	5.5	7.5	24 AC	5	3RA2324-8XB30-1AC2	5	3RA2324-8XB30-2AC2			
				110 AC	5	3RA2324-8XB30-1AG2	5	3RA2324-8XB30-2AG2			
				230 AC	5	3RA2324-8XB30-1AL2	5	3RA2324-8XB30-2AL2			
17	4	7.5	11	24 AC	5	3RA2325-8XB30-1AC2	5	3RA2325-8XB30-2AC2			
				110 AC	5	3RA2325-8XB30-1AG2	5	3RA2325-8XB30-2AG2			
				230 AC	5	3RA2325-8XB30-1AL2	5	3RA2325-8XB30-2AL2			
25	5.5	11	11	24 AC	5	3RA2326-8XB30-1AC2	5	3RA2326-8XB30-2AC2			
				110 AC	5	3RA2326-8XB30-1AG2	5	3RA2326-8XB30-2AG2			
				230 AC	5	3RA2326-8XB30-1AL2	5	3RA2326-8XB30-2AL2			
32	7.5	15	18.5	24 AC	5	3RA2327-8XB30-1AC2	5	3RA2327-8XB30-2AC2			
				110 AC	5	3RA2327-8XB30-1AG2	5	3RA2327-8XB30-2AG2			
				230 AC	5	3RA2327-8XB30-1AL2	5	3RA2327-8XB30-2AL2			
38	11	18.5	18.5	24 AC	5	3RA2328-8XB30-1AC2	5	3RA2328-8XB30-2AC2			
				110 AC	5	3RA2328-8XB30-1AG2	5	3RA2328-8XB30-2AG2			
				230 AC	5	3RA2328-8XB30-1AL2	5	3RA2328-8XB30-2AL2			
DC operation											
12	3	5.5	7.5	24 DC	2	3RA2324-8XB30-1BB4	2	3RA2324-8XB30-2BB4			
17	4	7.5	11	24 DC	2	3RA2325-8XB30-1BB4	2	3RA2325-8XB30-2BB4			
25	5.5	11	11	24 DC	2	3RA2326-8XB30-1BB4	2	3RA2326-8XB30-2BB4			
32	7.5	15	18.5	24 DC	2	3RA2327-8XB30-1BB4	2	3RA2327-8XB30-2BB4			
38	11	18.5	18.5	24 DC	2	3RA2328-8XB30-1BB4	2	3RA2328-8XB30-2BB4			
With voltage tap-off											
12	3	5.5	7.5	24 DC	2	3RA2324-8XE30-1BB4	2	3RA2324-8XE30-2BB4			
17	4	7.5	11	24 DC	2	3RA2325-8XE30-1BB4	5	3RA2325-8XE30-2BB4			
25	5.5	11	11	24 DC	2	3RA2326-8XE30-1BB4	2	3RA2326-8XE30-2BB4			
32	7.5	15	18.5	24 DC	5	3RA2327-8XE30-1BB4	2	3RA2327-8XE30-2BB4			
38	11	18.5	18.5	24 DC	2	3RA2328-8XE30-1BB4	2	3RA2328-8XE30-2BB4			

 Representation of the complete reversing contactor assemblies with optionally mountable accessories, [see page 3/148](#).

Switching Devices – Contactors and Contactor Assemblies – for Switching Motors

Reversing Contactor Assemblies

SIRIUS 3RA23 reversing contactor assemblies, up to 55 kW **IE3/IE4 ready**

Fully wired and tested reversing contactor assemblies · Size S2 · Up to 37 kW

AC operation  **or AC/DC operation** 

PU (UNIT, SET, M) = 1
 PS* = 1 unit
 PG = 41B



3RA233.-8XB30-1A.2



3RA233.-8XE30-1NB3

Rated data AC-2 and AC-3						Screw terminals		Spring-loaded terminals	
Operational current I_e up to 400 V	Rating of three-phase motors at 50 Hz and			Rated control supply voltage U_s	SD	Article No.	Price per PU	Article No.	Price per PU
	230 V	400 V	690 V						
A	kW	kW	kW	V	d				
AC operation, 50/60 Hz									
40	11	18.5	22	110 AC	2	3RA2335-8XB30-1AG2		--	
				230 AC	2	3RA2335-8XB30-1AL2		--	
50	15	22	22	110 AC	5	3RA2336-8XB30-1AG2		--	
				230 AC	2	3RA2336-8XB30-1AL2		--	
65	18.5	30	37	110 AC	5	3RA2337-8XB30-1AG2		--	
				230 AC	2	3RA2337-8XB30-1AL2		--	
80	22	37	45	110 AC	5	3RA2338-8XB30-1AG2		--	
				230 AC	2	3RA2338-8XB30-1AL2		--	
AC/DC operation									
With integrated coil circuit (varistor integrated in electronics at the factory)									
40	11	18.5	22	20 ... 33 AC/DC	2	3RA2335-8XB30-1NB3		--	
50	15	22	22	20 ... 33 AC/DC	2	3RA2336-8XB30-1NB3		--	
65	18.5	30	37	20 ... 33 AC/DC	2	3RA2337-8XB30-1NB3		--	
80	22	37	45	20 ... 33 AC/DC	2	3RA2338-8XB30-1NB3		--	
With voltage tap-off									
40	11	18.5	22	20 ... 33 AC/DC	5	3RA2335-8XE30-1NB3		--	
50	15	22	22	20 ... 33 AC/DC	5	3RA2336-8XE30-1NB3		--	
65	18.5	30	37	20 ... 33 AC/DC	5	3RA2337-8XE30-1NB3		--	
80	22	37	45	20 ... 33 AC/DC	5	3RA2338-8XE30-1NB3		--	

Representation of the complete reversing contactor assemblies with optionally mountable accessories, [see page 3/149](#).

Switching Devices – Contactors and Contactor Assemblies – for Switching Motors

Reversing Contactor Assemblies

IE3/IE4 ready SIRIUS 3RA23 reversing contactor assemblies, up to 55 kW



Fully wired and tested reversing contactor assemblies · Size S3 · Up to 55 kW
AC operation  **or AC/DC operation** 

 PU (UNIT, SET, M) = 1
 PS* = 1 unit
 PG = 41B

3RA234.-8XB30-1A.2



3RA234.-8XE30-1NB3

Rated data AC-2 and AC-3				Rated control supply voltage U_s ¹⁾	SD	Screw terminals 		SD	Spring-loaded terminals 		
Operational current I_e up to 400 V	Rating of three-phase motors at 50 Hz and					Article No.	Price per PU		Article No.	Price per PU	
A	230 V	400 V	690 V	V	d	d	d	d			
AC operation, 50/60 Hz											
80	22	37	55	110 AC	X	3RA2345-8XB30-1AG2	--				
				230 AC	X	3RA2345-8XB30-1AL2	--				
95	22	45	75	110 AC	X	3RA2346-8XB30-1AG2	--				
				230 AC	X	3RA2346-8XB30-1AL2	--				
110	30	55	75	110 AC	X	3RA2347-8XB30-1AG2	--				
				230 AC	X	3RA2347-8XB30-1AL2	--				
AC/DC operation											
With integrated coil circuit (varistor integrated in electronics at the factory)											
80	22	37	55	20 ... 33 AC/DC	X	3RA2345-8XB30-1NB3	--				
				20 ... 33 AC/DC	X	3RA2346-8XB30-1NB3	--				
110	30	55	75	20 ... 33 AC/DC	X	3RA2347-8XB30-1NB3	--				
With voltage tap-off¹⁾											
80	22	37	55	20 ... 33 AC/DC	X	3RA2345-8XE30-1NB3	--				
				20 ... 33 AC/DC	X	3RA2346-8XE30-1NB3	--				
110	30	55	75	20 ... 33 AC/DC	X	3RA2347-8XE30-1NB3	--				

¹⁾ The associated module connectors 3RA2711-0EE17 for the 3RA271. function modules must be ordered separately, see page 3/107.

Representation of the complete reversing contactor assemblies with optionally mountable accessories, see page 3/150.

Switching Devices – Contactors and Contactor Assemblies – for Switching Motors

Reversing Contactor Assemblies

Reversing contactor assemblies consisting of SIRIUS 3RT1 contactors, up to 250 kW

Overview

The individual parts for the reversing contactor assemblies for customer assembly must be ordered separately.

- 3RT contactors: The operating times of the individual 3RT10 contactors are rated in such a way that no overlapping of the contact making and the arcing time between two contactors can occur on reversing, provided they are interlocked by way of their auxiliary switches (NC contact interlock) and the mechanical interlock.

For assemblies with AC operation and 50/60 Hz, a dead interval of 50 ms must be provided when used with voltages over 500 V; a dead interval of 30 ms is recommended for use with voltages up to and including 400 V. These dead times do not apply to assemblies with DC operation.

The operating times of the individual contactors are not affected by the mechanical interlock.

- Mechanical interlock
- Wiring kits consisting of link rails
- Base plate

Additional components

- For momentary-contact operation: auxiliary switch (NO contact) for self-locking
- 3RB2 overload relays ([see page 7/117 onwards](#)), SIMOCODE pro 3UF7 motor management and control devices ([page 10/16 onwards](#)) or 3RN thermistor motor protection relays ([page 10/155](#)) can be used for overload protection.

More information

Homepage, [see www.siemens.com/sirius](http://www.siemens.com/sirius)

Industry Mall, [see www.siemens.com/product?3RA23_3RT1](http://www.siemens.com/product?3RA23_3RT1)

Switching Devices – Contactors and Contactor Assemblies – for Switching Motors

Reversing Contactor Assemblies

Reversing contactor assemblies consisting of SIRIUS 3RT1 contactors, up to 250 kW

Reversing contactor assemblies for customer assembly · Size S6 · Up to 90 kW

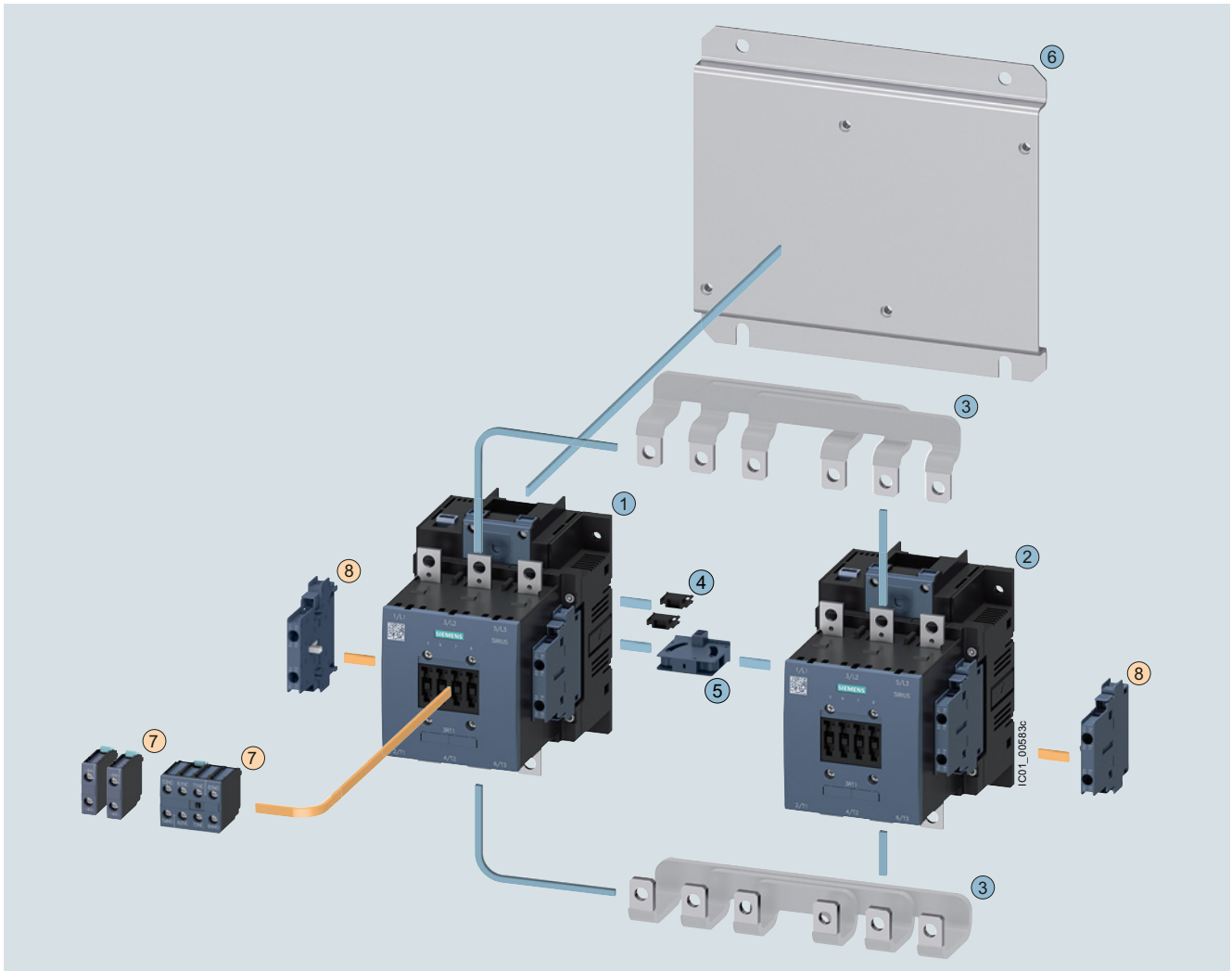

Mountable accessories (optional)

To be ordered separately	Type	Page
⑦ Auxiliary switch, front	3RH1921	3/96
⑧ Auxiliary switch, lateral	3RH1921	3/98

Reversing contactor assembly for customer assembly

Individual parts	Type		Page
	Q11	Q12	
① ② Contactors, 55 kW	3RT1054	3RT1054	3/70 ... 3/72
① ② Contactors, 75 kW	3RT1055	3RT1055	3/70 ... 3/72
① ② Contactors, 90 kW	3RT1056	3RT1056	3/70 ... 3/72
③ Assembly kit consisting of: Wiring modules on the top and bottom for contactors without box terminals for connecting the main and auxiliary circuits, electrical interlock included (NC contact interlock)	3RA1953-2A		3/109
④ Two connectors for two contactors	3RA1932-2D		3/113
⑤ Mechanical interlock (must be ordered separately)	3RA1954-2A		3/113
⑥ Base plate for reversing contactor assemblies	3RA1952-2A		3/118

Switching Devices – Contactors and Contactor Assemblies – for Switching Motors

Reversing Contactor Assemblies

Reversing contactor assemblies consisting of SIRIUS 3RT1 contactors, up to 250 kW

Reversing contactor assemblies for customer assembly · Size S10 · Up to 160 kW

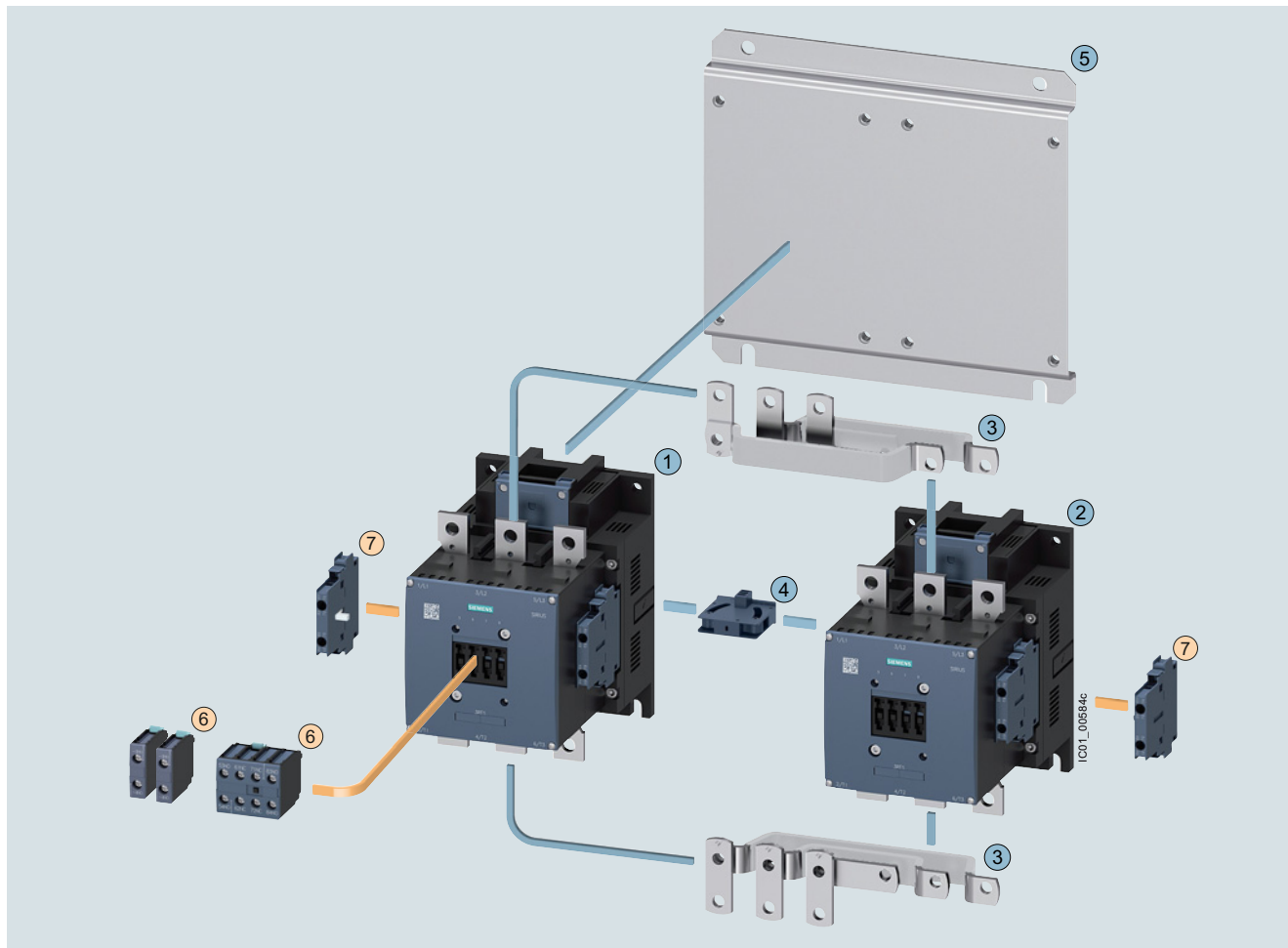

Mountable accessories (optional)

To be ordered separately	Type	Page
⑥ Auxiliary switch, front	3RH1921	3/96
⑦ Auxiliary switch, lateral	3RH1921	3/98

Reversing contactor assembly for customer assembly

Individual parts	Type		Page
	Q11	Q12	
①② Contactors, 110 kW	3RT1.64	3RT1.64	3/70 ... 3/72, 3/134
①② Contactors, 132 kW	3RT1.65	3RT1.65	3/70 ... 3/72, 3/134
①② Contactors, 160 kW	3RT1.66	3RT1.66	3/70 ... 3/72, 3/134
③ Assembly kit consisting of: Wiring modules on the top and bottom for contactors without box terminals for connecting the main and auxiliary circuits, electrical interlock included (NC contact interlock)	3RA1963-2A		3/109
④ Mechanical interlock (must be ordered separately)	3RA1954-2A		3/113
⑤ Base plate for reversing contactor assemblies	3RA1962-2A		3/118

Switching Devices – Contactors and Contactor Assemblies – for Switching Motors

Reversing Contactor Assemblies

Reversing contactor assemblies consisting of SIRIUS 3RT1 contactors, up to 250 kW

Reversing contactor assemblies for customer assembly · Size S12 · Up to 250 kW

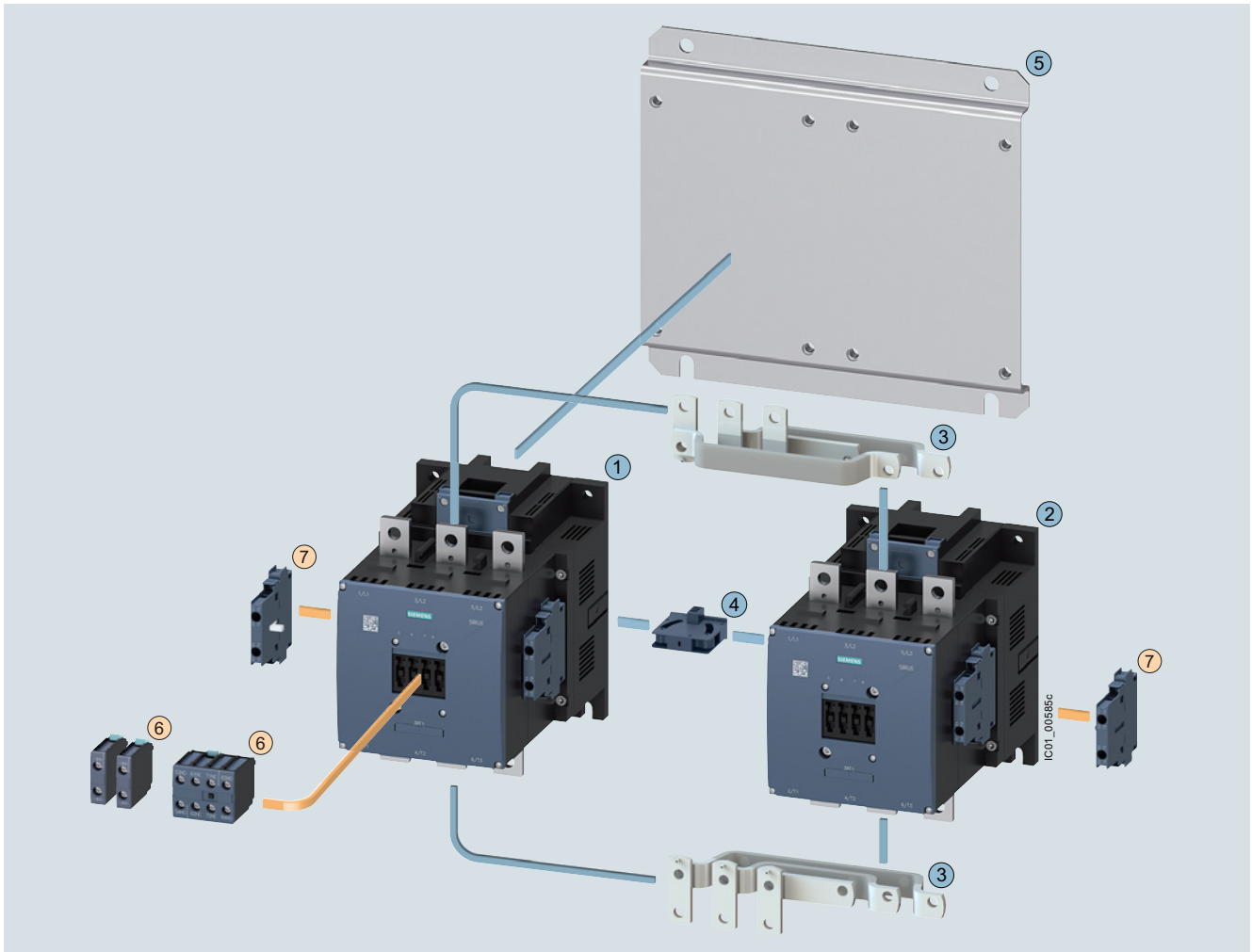

Mountable accessories (optional)

To be ordered separately	Type	Page
⑥ Auxiliary switch, front	3RH1921	3/96
⑦ Auxiliary switch, lateral	3RH1921	3/98

Reversing contactor assembly for customer assembly

Individual parts	Type		Page
	Q11	Q12	
①② Contactors, 200 kW	3RT1.75	3RT1.75	3/70 ... 3/72, 3/134
①② Contactors, 250 kW	3RT1.76	3RT1.76	3/70 ... 3/72, 3/134
③ Assembly kit consisting of: Wiring modules on the top and bottom for contactors without box terminals for connecting the main and auxiliary circuits, electrical interlock included (NC contact interlock)	3RA1973-2A		3/109
④ Mechanical interlock (must be ordered separately)	3RA1954-2A		3/113
⑤ Base plate for reversing contactor assemblies	3RA1972-2A		3/118

Switching Devices – Contactors and Contactor Assemblies – for Switching Motors

Contactor Assemblies for Star-Delta (Wye-Delta) Starting

SIRIUS 3RA24 contactor assemblies for star-delta (wye-delta) starting, up to 90 kW

Overview

More information

Homepage, see www.siemens.com/sirius

Industry Mall, see www.siemens.com/product?3RA24_3RT

Conversion tool for article numbers, see www.siemens.com/sirius/conversion-tool

TIA Selection Tool Cloud (TST Cloud), see <https://www.siemens.com/tstcloud/?node=LoadFeeder>

The 3RA24 contactor assemblies for star-delta (wye-delta) starting in sizes S00 to S3 can be ordered as follows:

- Fully wired and tested, with electrical and mechanical interlock, see [page 3/169 onwards](#).
- For all individual parts for customer assembly, see [page 3/75 onwards](#).

The 3RA24 contactor assemblies for star-delta (wye-delta) starting have screw or spring-loaded terminals and are suitable for screw fixing and snap-on mounting onto TH 35 standard mounting rails.

A base plate is also available for the size S2 and S3 assemblies.

A dead interval of 50 ms on reversing is already integrated in the 3RA28 function module for star-delta (wye-delta) starting.

With the fully wired and tested 3RA24 contactor assemblies for star-delta (wye-delta) starting, the auxiliary contacts included in the basic units are unassigned.

The 3RA24 contactor assemblies for star-delta (wye-delta) starting are designed for standard applications.

Note:

Contactor assemblies for star-delta (wye-delta) starting in special applications such as very heavy starting¹⁾ or star-delta (wye-delta) starting of special motors must be customized. Help with designing such special applications is available from our Technical Support:

<https://support.industry.siemens.com/My/ww/en/requests>

¹⁾ For effective assistance from Technical Support, you must provide the following details:

- Rated motor voltage
- Rated motor current
- Service factor, operating values
- Motor starting current factor
- Starting time
- Ambient temperature

Surge suppression

Surge suppression (varistor) is included in the 3RA28 function modules for star-delta (wye-delta) starting.

Motor protection

3RU2 overload relays (see [page 7/92 onwards](#)) or 3RB3 overload relays (see [page 7/105 onwards](#)) for contactor mounting or stand-alone installation, SIMOCODE pro 3UF7 motor management and control devices ([page 10/16 onwards](#)) or 3RN thermistor motor protection relays ([page 10/155](#)) can be used for motor protection.

The overload relay can either be mounted onto the line contactor or fitted separately. It must be set to 0.58 times the rated motor current.

SIRIUS 3RA28 function module for star-delta (wye-delta) starting

The 3RA2816-0EW20 star-delta (wye-delta) function module (see [page 3/105](#)) replaces the complete wiring in the control circuit and can be used in the voltage range from 24 to 240 V AC/DC. It is snapped onto the front of the contactor assembly for star-delta (wye-delta) starting size S00, S0, S2 or S3.

One function module comprises a complete module kit:

- Basic module with integrated control logic and time setting
- Two coupling modules with corresponding connection cables

The scope of supply thus comprises a complete module kit for one contactor assembly for star-delta (wye-delta) starting in size S00, S0, S2 or S3, regardless of the connection method.

Data of the control circuit:

- Wide voltage range 24 to 240 V AC/DC
- Time setting range 0.5 to 60 s (3 selectable settings)
- Dead interval of 50 ms, non-adjustable

Switching Devices – Contactors and Contactor Assemblies – for Switching Motors



Contactor Assemblies for Star-Delta (Wye-Delta) Starting

SIRIUS 3RA24 contactor assemblies for star-delta (wye-delta) starting, up to 90 kW

Complete units

Note:

The selection of contactor types refers to fused designs.

Rated data at 50 Hz 400 V AC			Size	Type		Fully wired and tested contactor assemblies for star-delta (wye-delta) starting
Rating <i>P</i> kW	Operational current I_e A	Motor current A		Line/delta contactor	Star contactor	
 Screw terminals						
5.5	12	9.5 ... 13.8	S00-S00-S00	3RT2015-1...	3RT2015-1...	3RA2415-8XF31-1...
7.5	16	12.1 ... 17		3RT2017-1...	3RT2015-1...	3RA2416-8XF31-1...
11	25	19 ... 25		3RT2018-1...	3RT2016-1...	3RA2417-8XF31-1...
11	25	19 ... 25	S0-S0-S0	3RT2024-1...0	3RT2024-1...0	3RA2423-8XF32-1...
15	32	24.1 ... 34		3RT2026-1...0	3RT2024-1...0	3RA2425-8XF32-1...
18.5	40	34.5 ... 40		3RT2026-1...0	3RT2024-1...0	3RA2425-8XF32-1...
22	50	31 ... 43		3RT2027-1...0	3RT2026-1...0	3RA2426-8XF32-1...
22/30	50	31 ... 43	S2-S2-S0	3RT2035-1...0	3RT2026-1...0	3RA2434-8XF32-1...
37	80	62.1 ... 77.8		3RT2035-1...0	3RT2027-1...0	3RA2435-8XF32-1...
45	86	69 ... 86		3RT2036-1...0	3RT2028-1...0	3RA2436-8XF32-1...
55	115	77.6 ... 108.6	S2-S2-S2	3RT2037-1...0	3RT2035-1...0	3RA2437-8XF32-1...
55	115	77.6 ... 108.6	S3-S3-S2	3RT2045-1...0	3RT2035-1...0	3RA2444-8XF32-1...
75	150	120.7 ... 150		3RT2045-1...0	3RT2036-1...0	3RA2445-8XF32-1...
90	160	86 ... 160		3RT2046-1...0	3RT2037-1...0	3RA2446-8XF32-1...
 Spring-loaded terminals						
5.5	12	9.5 ... 13.8	S00-S00-S00	3RT2015-2...	3RT2015-2...	3RA2415-8XF31-2...
7.5	16	12.1 ... 17		3RT2017-2...	3RT2015-2...	3RA2416-8XF31-2...
11	25	19 ... 25		3RT2018-2...	3RT2016-2...	3RA2417-8XF31-2...
11	25	19 ... 25	S0-S0-S0	3RT2024-2...0	3RT2024-2...0	3RA2423-8XF32-2...
15	32	24.1 ... 34		3RT2026-2...0	3RT2024-2...0	3RA2425-8XF32-2...
18.5	40	34.5 ... 40		3RT2026-2...0	3RT2024-2...0	3RA2425-8XF32-2...
22	50	31 ... 43		3RT2027-2...0	3RT2026-2...0	3RA2426-8XF32-2...

Article No. scheme

Product versions	Article number
SIRIUS contactor assembly for star-delta (wye-delta) starting	3RA24 <input type="checkbox"/> <input type="checkbox"/> - <input type="checkbox"/> <input type="checkbox"/> <input type="checkbox"/> <input type="checkbox"/> - <input type="checkbox"/> <input type="checkbox"/> <input type="checkbox"/>
Size of the contactor e.g. 4 = S3	<input type="checkbox"/>
Rating dependent on size e.g. 5 = 75 kW for size S3	<input type="checkbox"/>
Type of overload relay e.g. 8X = Without	<input type="checkbox"/> <input type="checkbox"/>
Assembly e.g. F = Ready-assembled with function modules	<input type="checkbox"/>
Interlock e.g. 3 = Mechanical and electrical	<input type="checkbox"/>
Free auxiliary switches e.g. 2 = S3: 3 NO + 3 NC total	<input type="checkbox"/>
Type of electrical connection e.g. 1 = Screw terminals (main and auxiliary circuits)	<input type="checkbox"/>
Operating range/solenoid coil circuit e.g. A = AC standard/without coil circuit	<input type="checkbox"/>
Rated control supply voltage e.g. L2 = 230 V AC, 50/60 Hz	<input type="checkbox"/> <input type="checkbox"/>
Example	3RA24 4 5 - 8 X F 3 2 - 1 A L 2

Note:

The Article No. scheme shows an overview of product versions for better understanding of the logic behind the article numbers.

For your orders, please use the article numbers quoted in the selection and ordering data.

Switching Devices – Contactors and Contactor Assemblies – for Switching Motors

Contactor Assemblies for Star-Delta (Wye-Delta) Starting

SIRIUS 3RA24 contactor assemblies for star-delta (wye-delta) starting, up to 90 kW

Fully wired and tested contactor assemblies for star-delta (wye-delta) starting · Size S00-S00-S00 · Up to 11 kW

The figure shows the version with screw terminals

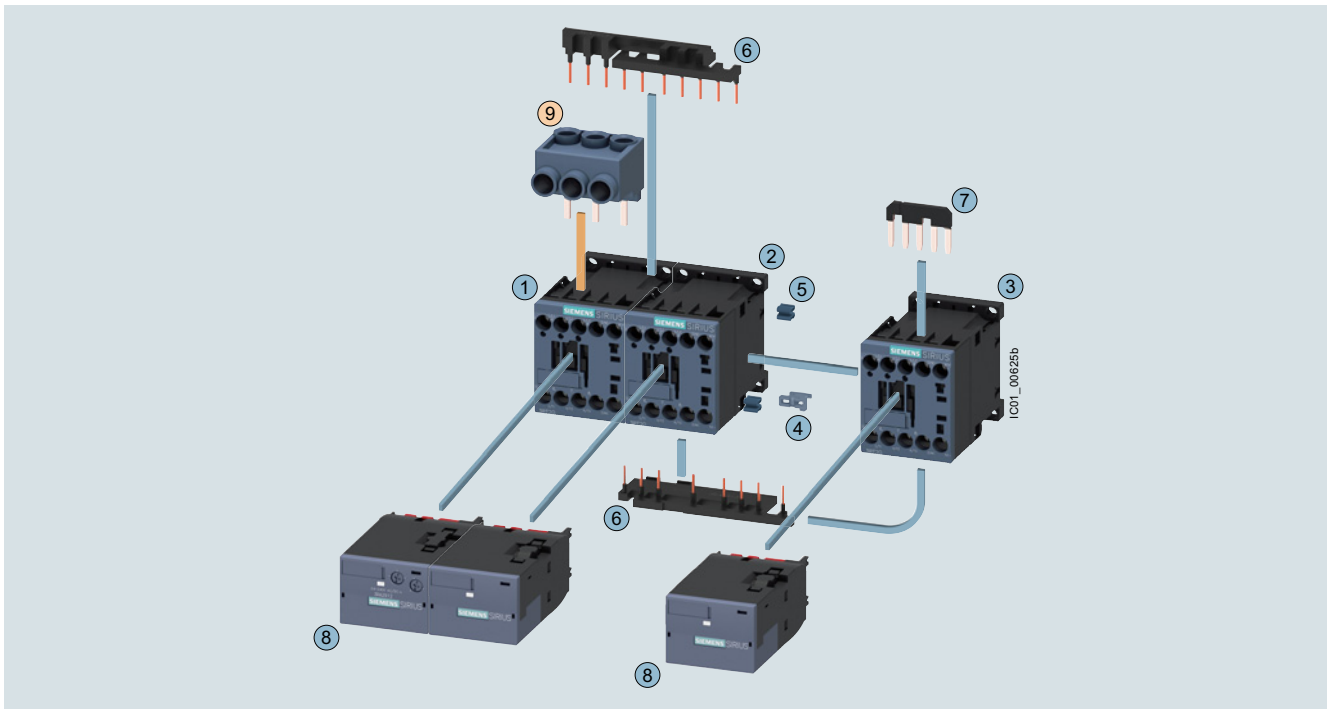

Mountable accessories (optional)

To be ordered separately	Type	Page
⑨ Three-phase infeed terminal ¹⁾	3RA2913-3K	3/115

Complete contactor assembly for star-delta (wye-delta) starting

Individual parts	Type			Page
	Q11 ²⁾	Q13	Q12	
①②③ Contactors, 5.5 kW	3RT2015	3RT2015	3RT2015	3/54, 3/61
①②③ Contactors, 7.5 kW	3RT2017	3RT2017	3RT2015	3/54, 3/61
①②③ Contactors, 11 kW	3RT2018	3RT2018	3RT2016	3/54, 3/61
④ ... ⑦ Assembly kit S00-S00-S00 comprising:	3RA2913-2BB1			3/110
④ Mechanical interlock				
⑤ Four connecting clips for three contactors				
⑥ Wiring modules on top and bottom for connecting the main and auxiliary circuits				
⑦ Star jumper				
⑧ Function modules for star-delta (wye-delta) starting	3RA2816-0EW20			3/105

¹⁾ Part ⑨ can only be mounted for contactors with screw terminals.

²⁾ The version with 1 NO is required for momentary-contact operation.

Complete contactor assemblies for star-delta (wye-delta) starting, see page 3/169.

Switching Devices – Contactors and Contactor Assemblies – for Switching Motors

Contactor Assemblies for Star-Delta (Wye-Delta) Starting

SIRIUS 3RA24 contactor assemblies for star-delta (wye-delta) starting, up to 90 kW

Fully wired and tested contactor assemblies for star-delta (wye-delta) starting · Size S0-S0-S0 · Up to 22 kW

The figure shows the version with screw terminals

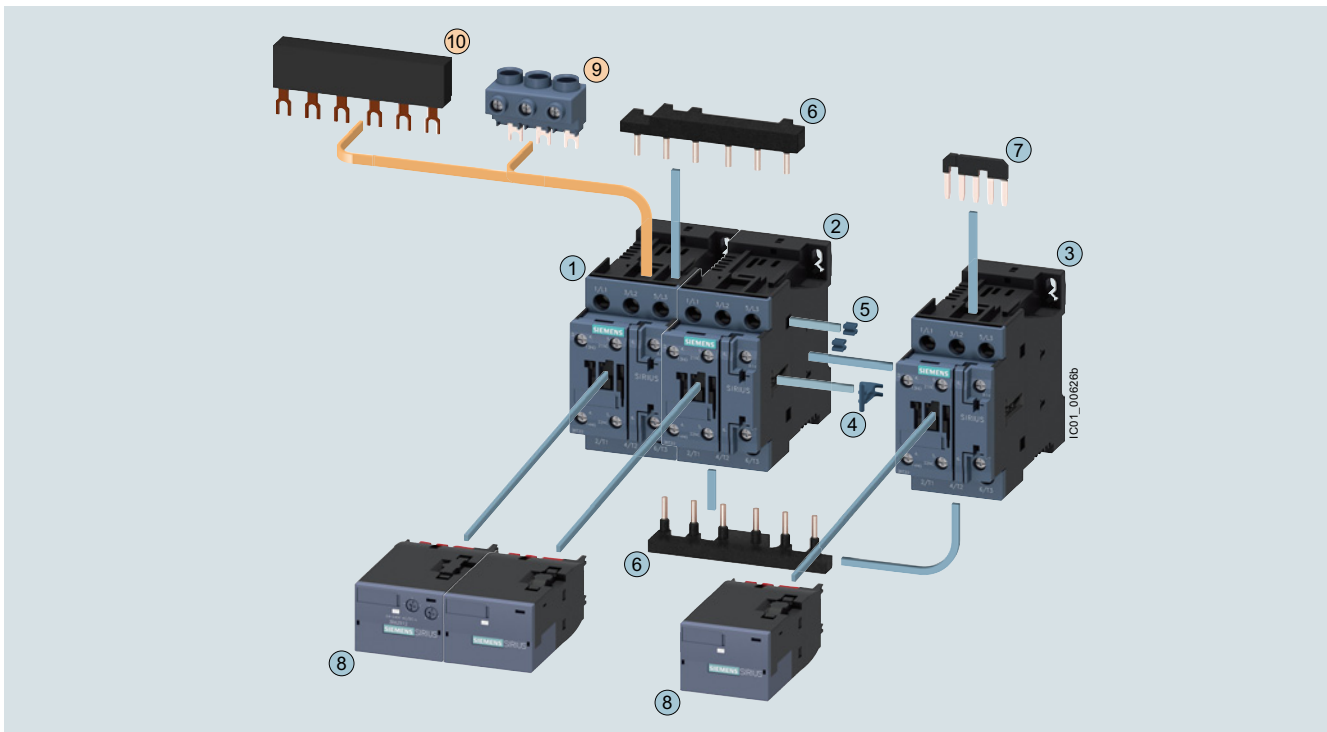

Mountable accessories (optional)

To be ordered separately	Type	Page
⑨ Three-phase infeed terminal ¹⁾	3RV2925-5AB	3/115
⑩ Three-phase busbar ¹⁾	3RV1915-1AB	3/115

Complete contactor assembly for star-delta (wye-delta) starting

Individual parts	Type	Q11	Q13	Q12	Page
①②③ Contactors, 11 kW	3RT2024	3RT2024	3RT2024		3/55, 3/65
①②③ Contactors, 15/18.5 kW	3RT2026	3RT2026	3RT2026		3/55, 3/65
①②③ Contactors, 22 kW	3RT2027	3RT2027	3RT2026		3/55, 3/65
④ ... ⑦ Assembly kit S0-S0-S0 comprising:	3RA2923-2BB1				3/110
④ Mechanical interlock					
⑤ Four connecting clips for three contactors					
⑥ Wiring modules on top and bottom for connecting the main and auxiliary circuits					
⑦ Star jumper					
⑧ Function modules for star-delta (wye-delta) starting	3RA2816-0EW20				3/105

¹⁾ The parts ⑨ and ⑩ can only be mounted for contactors with screw terminals, the wiring modules ⑥ must be removed beforehand.

Complete contactor assemblies for star-delta (wye-delta) starting, see page 3/170.

Switching Devices – Contactors and Contactor Assemblies – for Switching Motors

Contactor Assemblies for Star-Delta (Wye-Delta) Starting

SIRIUS 3RA24 contactor assemblies for star-delta (wye-delta) starting, up to 90 kW

Fully wired and tested contactor assemblies for star-delta (wye-delta) starting · Size S2-S2-S0¹⁾ · Up to 45 kW and S2-S2-S2 · 55 kW

The figure shows the version with screw terminals in S2-S2-S2

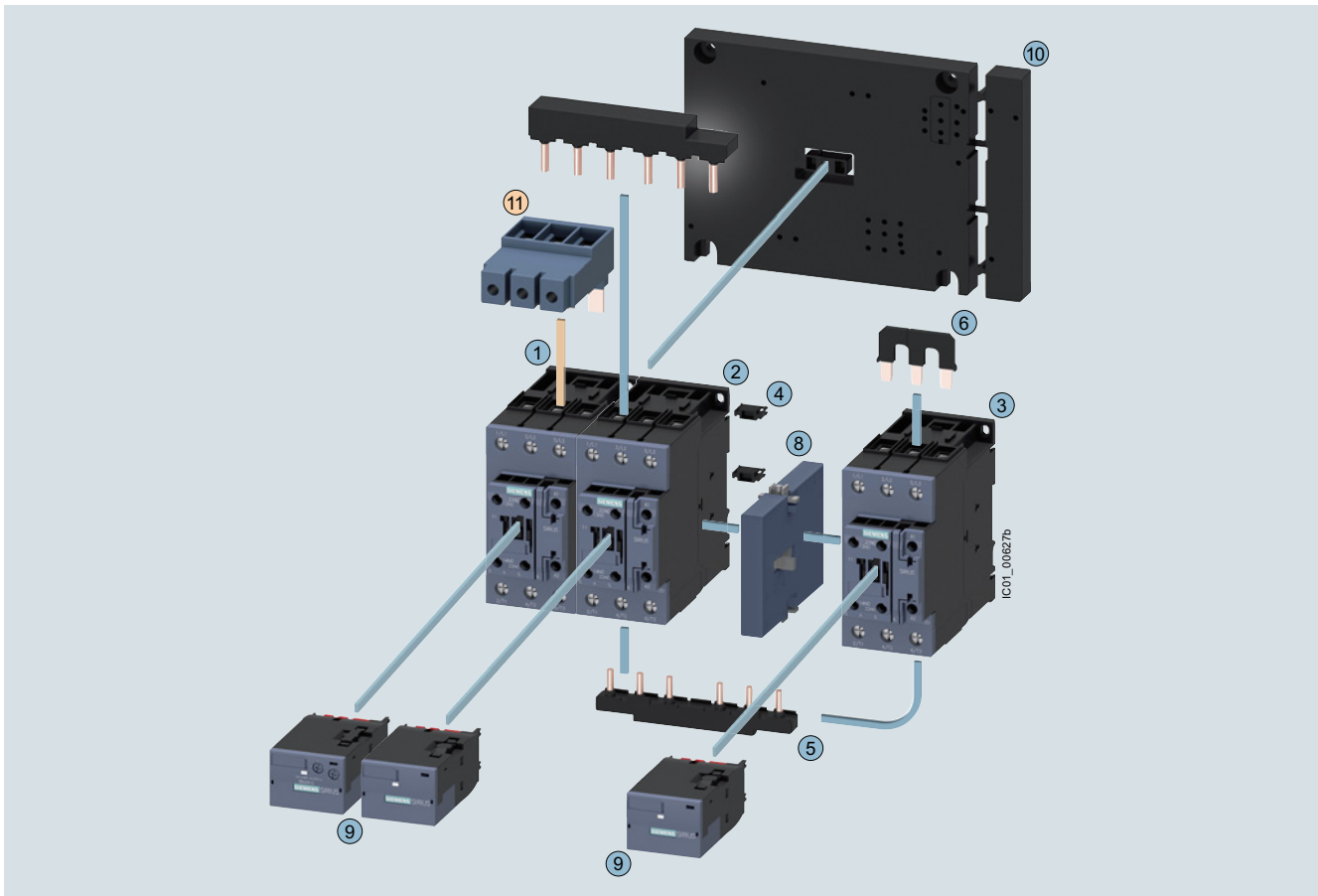

Mountable accessories (optional)

To be ordered separately	Type	Page
⑪ Three-phase infeed terminal	3RV2935-5A	3/115

Complete contactor assembly for star-delta (wye-delta) starting

Individual parts	Type			Page
	Q11	Q13	Q12	
①②③ Contactors, 22/30 kW	3RT2035	3RT2035	3RT2026	3/57, 3/66
①②③ Contactors, 37 kW	3RT2035	3RT2035	3RT2027	3/57, 3/66
①②③ Contactors, 45 kW	3RT2036	3RT2036	3RT2028	3/57, 3/66
①②③ Contactors, 55 kW	3RT2037	3RT2037	3RT2035	3/57, 3/66
④ ... ⑦ Assembly kit S2-S2-S2 comprising:	3RA2933-2BB1			3/110
④ Four connectors for three contactors (not required for fully pre-wired contactor assemblies for star-delta (wye-delta) starting)				
⑤ Wiring modules on top and bottom for connecting the main and auxiliary circuits				
⑥ Star jumper S2				
⑦ Cable for connecting the A2 coil contact from the line contactor with the A2 coil contact of the delta contactor (not shown in the drawing)				
⑧ Mechanical interlock	3RA2934-2B			3/113
⑨ Function modules for star-delta (wye-delta) starting	3RA2816-0EW20			3/105
⑩ Base plate star-delta (wye-delta)	3RA2932-2F			3/118

¹⁾ Complete contactor assembly for star-delta (wye-delta) starting in size S2-S2-S0 (not shown): The 3RA2933-2C assembly kit is to be used here, see page 3/110.

Complete contactor assemblies for star-delta (wye-delta) starting, see page 3/171.

Switching Devices – Contactors and Contactor Assemblies – for Switching Motors

Contactor Assemblies for Star-Delta (Wye-Delta) Starting

SIRIUS 3RA24 contactor assemblies for star-delta (wye-delta) starting, up to 90 kW

Fully wired and tested contactor assemblies for star-delta (wye-delta) starting · Size S3-S3-S2¹⁾ · Up to 90 kW

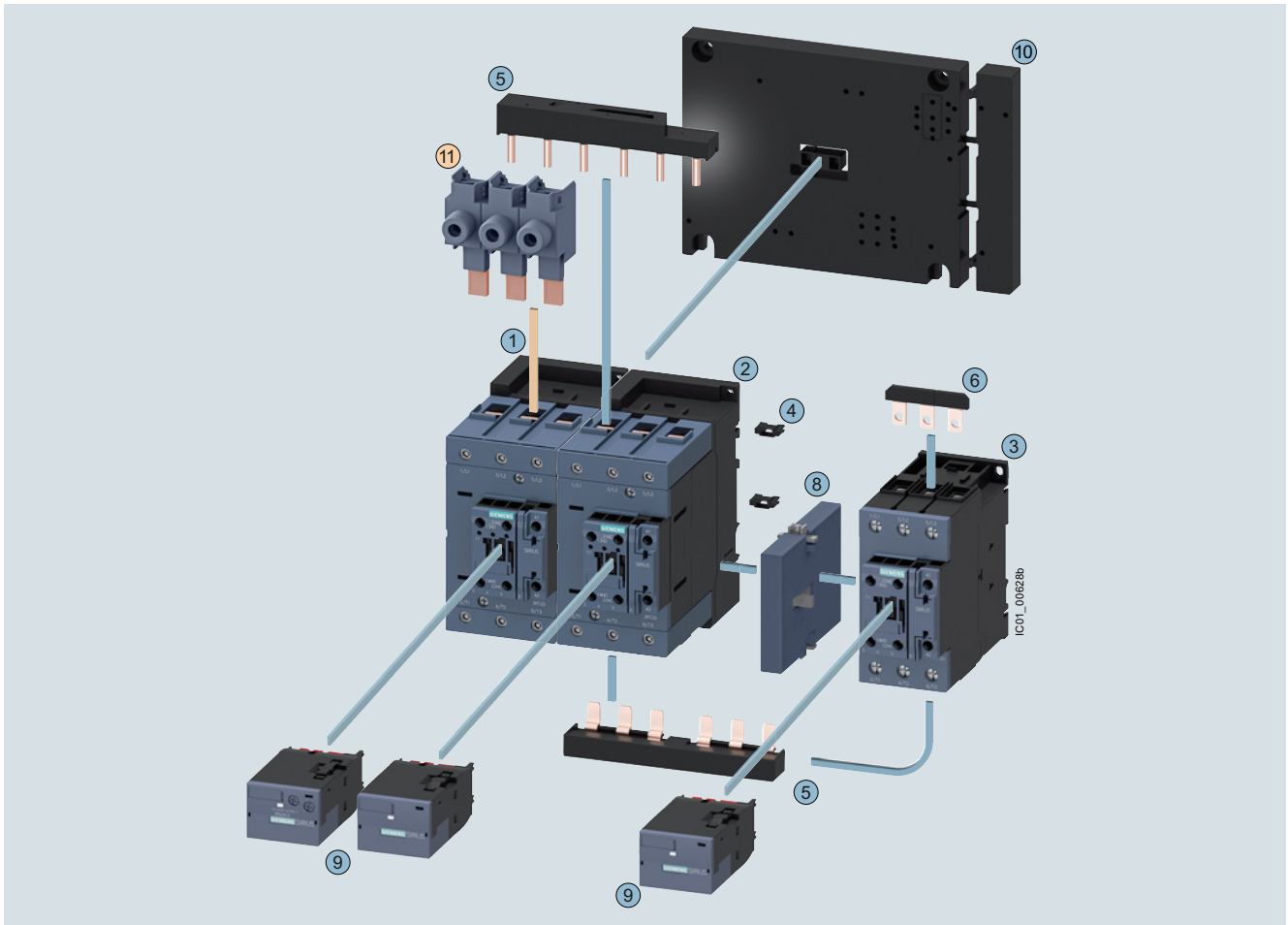

Mountable accessories (optional)

To be ordered separately	Type	Page
⑪ Single-phase infeed terminal (3 units are required)	3RA2943-3L	3/115

Complete contactor assembly for star-delta (wye-delta) starting

Individual parts	Type			Page
	Q11	Q13	Q12	
① ② ③ Contactors, 55 kW	3RT2045	3RT2045	3RT2035	3/58, 3/66
① ② ③ Contactors, 75 kW	3RT2045	3RT2045	3RT2036	3/58, 3/66
① ② ③ Contactors, 90 kW	3RT2046	3RT2046	3RT2037	3/58, 3/66
④ ... ⑦ Assembly kit S3-S3-S2 comprising:	3RA2943-2C			3/110
④ Two connectors for three contactors (not required for fully pre-wired contactor assemblies for star-delta (wye-delta) starting)				
⑤ Wiring modules on top and bottom (S3-S2) for connecting the main and auxiliary circuits and a cable set for the auxiliary circuit				
⑥ Star jumper S2				
⑦ Cable for connecting the A2 coil contact from the line contactor with the A2 coil contact of the delta contactor (not shown in the drawing)				
⑧ Mechanical interlock	3RA2934-2B			3/113
⑨ Function modules for star-delta (wye-delta) starting	3RA2816-0EW20			3/105
⑩ Base plate star-delta (wye-delta)	3RA2942-2F			3/118

¹⁾ Contactor assembly for star-delta (wye-delta) starting for customer assembly in size S3-S3-S3 (not shown): The 3RA2943-2BB. assembly kit is to be used here, see page 3/110.

Complete contactor assemblies for star-delta (wye-delta) starting, see page 3/172.

Switching Devices – Contactors and Contactor Assemblies – for Switching Motors

Contactor Assemblies for Star-Delta (Wye-Delta) Starting

SIRIUS 3RA24 contactor assemblies for star-delta (wye-delta) starting, up to 90 kW

Technical specifications

More information

Technical specifications, see <https://support.industry.siemens.com/cs/ww/en/ps/16150/td>
 FAQs, see <https://support.industry.siemens.com/cs/ww/en/ps/16150/faq>

System Manual "SIRIUS – System Overview", see <https://support.industry.siemens.com/cs/ww/en/view/60311318>
 Equipment Manual "SIRIUS – SIRIUS 3RT Contactors/Contactor Assemblies", see <https://support.industry.siemens.com/cs/ww/en/view/60306557>
 Application Manual "SIRIUS Controls with IE3/IE4 motors", see <https://support.industry.siemens.com/cs/ww/en/view/94770820>

Unless otherwise indicated below, the technical specifications correspond to those of the 3RT individual contactors (see page 3/22 onwards) and 3RU2 overload relays (see page 7/88 onwards).

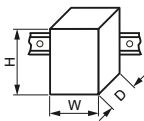
Type		3RA2415	3RA2416	3RA2417	3RA2423	3RA2425	3RA2426
Sizes		S00-S00-S00	S00-S00-S00	S00-S00-S00	S0-S0-S0	S0-S0-S0	S0-S0-S0
General data							
Dimensions (W x H x D) with function module							
• AC operation							
- Screw terminals		mm	135 x 68 x 145		135 x 101 x 171		
- Spring-loaded terminals		mm	135 x 84 x 145		135 x 114 x 171		
• DC operation							
- Screw terminals		mm	135 x 68 x 145		135 x 101 x 181		
- Spring-loaded terminals		mm	135 x 84 x 145		135 x 114 x 181		
Individual contactors							
• Q11 line contactor	Type	3RT2015	3RT2017	3RT2018	3RT2024	3RT2026	3RT2027
• Q13 delta contactor	Type	3RT2015	3RT2017	3RT2018	3RT2024	3RT2026	3RT2027
• Q12 star contactor	Type	3RT2015	3RT2015	3RT2016	3RT2024	3RT2024	3RT2026
Mechanical endurance							
	Operating cycles	3 million					
Unassigned auxiliary contacts of the individual contactors							
For circuit diagrams of the control circuit, see Equipment Manual for contactors/contacter assemblies .							
Short-circuit protection							
Main circuit without overload relays							
• Fuse links, operational class gG: LV HRC, type 3NA; DIAZED, type 5SB; NEOZED, type 5SE with single or double infeed							
Greatest rated current of the fuse according to IEC 60947-4-1							
- Type of coordination "1"	A	35		63		100	125
- Type of coordination "2"	A	20		25		35	63
Auxiliary circuit							
Short-circuit test							
• With fuse links, operational class gG: DIAZED, type 5SB; NEOZED, type 5SE with short-circuit current $I_k = 1$ kA acc. to IEC 60947-5-1	A	10					
	A	6 (up to $I_k < 0.5$ kA; ≤ 260 V), if the auxiliary contact of the overload relay is connected in the contactor coil circuit.					
• With miniature circuit breaker, C characteristic with short-circuit current $I_k = 400$ A	A	10					
	A	6 (up to $I_k < 0.5$ kA; ≤ 260 V), if the auxiliary contact of the overload relay is connected in the contactor coil circuit					
Short-circuit protection with overload relay							
See Configuration Manual for load feeders							

Switching Devices – Contactors and Contactor Assemblies – for Switching Motors

Contactor Assemblies for Star-Delta (Wye-Delta) Starting

SIRIUS 3RA24 contactor assemblies for star-delta (wye-delta) starting, up to 90 kW

Type		3RA2415	3RA2416	3RA2417	3RA2423	3RA2425	3RA2426
Sizes		S00-S00-S00	S00-S00-S00	S00-S00-S00	S0-S0-S0	S0-S0-S0	S0-S0-S0
Rated data of the main contacts							
Current-carrying capacity with reversing time up to 10 s							
• Rated operational current I_e	At 400 V	A	12	17	25	40	55
	690 V	A	6.9	9	20.8	22.5	35
• Rated power for three-phase motors with 50 Hz and 60 Hz	At 230 V	kW	3.3	4.7	7.2	12	16.6
	400 V	kW	5.8	8.2	12.5	21	30.1
	690 V	kW	5.8	7.5	18	20.4	33
• Switching frequency with overload relay		1/h	15				
Current-carrying capacity with reversing time up to 15 s							
• Rated operational current I_e	At 400 V	A	12	17	25	31	44
	690 V	A	6.9	9	20.8	22.5	35
• Rated power for three-phase motors with 50 Hz and 60 Hz	At 230 V	kW	3.3	4.7	7.2	9.4	13.8
	400 V	kW	5.8	8.2	12.5	16.3	24
	690 V	kW	5.8	7.5	18	20.4	33
• Switching frequency with overload relay		1/h	15				
Current-carrying capacity with reversing time up to 20 s							
• Rated operational current I_e	At 400 V	A	12	17	25	28	39
	690 V	A	6.9	9	20.8	22.5	35
• Rated power for three-phase motors with 50 Hz and 60 Hz	At 230 V	kW	3.3	4.7	7.2	8.5	12.2
	400 V	kW	5.8	8.2	12.5	14.7	21.3
	690 V	kW	5.8	7.5	18	20.4	33
• Switching frequency with overload relay		1/h	15				

Switching Devices – Contactors and Contactor Assemblies – for Switching Motors

Contactor Assemblies for Star-Delta (Wye-Delta) Starting

SIRIUS 3RA24 contactor assemblies for star-delta (wye-delta) starting, up to 90 kW

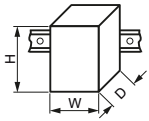
Type		3RA2434	3RA2435	3RA2436	3RA2437	3RA2444	3RA2445	3RA2446
Sizes		S2-S2-S0	S2-S2-S0	S2-S2-S0	S2-S2-S2	S3-S3-S2	S3-S3-S2	S3-S3-S2
General data								
Dimensions (W x H x D) with function module								
<ul style="list-style-type: none"> AC and DC operation Screw terminals 		mm	177.5 x 142 x 223			220 x 180 x 244		
Individual contactors								
• Q11 line contactor	Type	3RT2035	3RT2035	3RT2036	3RT2037	3RT2045	3RT2045	3RT2046
• Q13 delta contactor	Type	3RT2035	3RT2035	3RT2036	3RT2037	3RT2045	3RT2045	3RT2046
• Q12 star contactor	Type	3RT2026	3RT2027	3RT2028	3RT2035	3RT2035	3RT2036	3RT2037
Mechanical endurance		Operating cycles	1 million					
Unassigned auxiliary contacts of the individual contactors		For circuit diagrams of the control circuit, see Equipment Manual .						
Short-circuit protection								
Main circuit without overload relays								
<ul style="list-style-type: none"> Fuse links, operational class gG: LV HRC, type 3NA; DIAZED, type 5SB; NEOZED, type 5SE with single or double infeed 								
Greatest rated current of the fuse according to IEC 60947-4-1								
- Type of coordination "1"	A	160			250			
- Type of coordination "2"	A	80			125		160	
Auxiliary circuit								
Short-circuit test								
• With fuse links, operational class gG: DIAZED, type 5SB; NEOZED, type 5SE with short-circuit current $I_k = 1$ kA acc. to IEC 60947-5-1	A	10	6 (up to $I_k < 0.5$ kA; ≤ 260 V), if the auxiliary contact of the overload relay is connected in the contactor coil circuit.					
• With miniature circuit breaker, C characteristic with short-circuit current $I_k = 400$ A	A	10	6 (up to $I_k < 0.5$ kA; ≤ 260 V), if the auxiliary contact of the overload relay is connected in the contactor coil circuit.					
Short-circuit protection with overload relay		See Configuration Manual for load feeders				On request		
Rated data of the main contacts								
Current-carrying capacity with reversing time up to 10 s								
• Rated operational current I_e	At 400 V	A	On request					
	690 V	A	On request					
• Rated power for three-phase motors with 50 Hz and 60 Hz	At 230 V	kW	On request					
	400 V	kW	On request					
	690 V	kW	On request					
• Switching frequency with overload relay		1/h	15					
Current-carrying capacity with reversing time up to 15 s								
• Rated operational current I_e	At 400 V	A	On request					
	690 V	A	On request					
• Rated power for three-phase motors with 50 Hz and 60 Hz	At 230 V	kW	On request					
	400 V	kW	On request					
	690 V	kW	On request					
• Switching frequency with overload relay		1/h	15					
Current-carrying capacity with reversing time up to 20 s								
• Rated operational current I_e	At 400 V	A	On request					
	690 V	A	On request					
• Rated power for three-phase motors with 50 Hz and 60 Hz	At 230 V	kW	On request					
	400 V	kW	On request					
	690 V	kW	On request					
• Switching frequency with overload relay		1/h	15					

Switching Devices – Contactors and Contactor Assemblies – for Switching Motors

Contactor Assemblies for Star-Delta (Wye-Delta) Starting

IE3/IE4 ready SIRIUS 3RA24 contactor assemblies for star-delta (wye-delta) starting, up to 90 kW

Selection and ordering data

Fully wired and tested contactor assemblies for star-delta (wye-delta) starting · Size S00-S00-S00 · Up to 11 kW
AC operation  or DC operation 



PU (UNIT, SET, M) = 1
PS* = 1 unit
PG = 41B



3RA241.-8XF31-1A.0

3RA241.-8XF31-2A.0

3RA241.-8XE31-2BB4

Rated data AC-3				Rated control supply voltage U_s	SD	Screw terminals 		Spring-loaded terminals 	
Operational current I_e up to 400 V	Rating of three-phase motors at 50 Hz and					Article No.	Price per PU	Article No.	Price per PU
A	230 V	400 V	690 V	V	d	d	d	d	
AC operation, 50/60 Hz									
12	3.3	5.5	9.2	24 AC	2	3RA2415-8XF31-1AB0	2	3RA2415-8XF31-2AB0	
				110 AC	2	3RA2415-8XF31-1AF0	5	3RA2415-8XF31-2AF0	
				230 AC	2	3RA2415-8XF31-1AP0	2	3RA2415-8XF31-2AP0	
16	4.7	7.5	9.2	24 AC	2	3RA2416-8XF31-1AB0	5	3RA2416-8XF31-2AB0	
				110 AC	2	3RA2416-8XF31-1AF0	5	3RA2416-8XF31-2AF0	
				230 AC	2	3RA2416-8XF31-1AP0	2	3RA2416-8XF31-2AP0	
25	5.5	11	11	24 AC	2	3RA2417-8XF31-1AB0	5	3RA2417-8XF31-2AB0	
				110 AC	2	3RA2417-8XF31-1AF0	5	3RA2417-8XF31-2AF0	
				230 AC	2	3RA2417-8XF31-1AP0	2	3RA2417-8XF31-2AP0	
DC operation									
12	3.3	5.5	9.2	24 DC	2	3RA2415-8XF31-1BB4	2	3RA2415-8XF31-2BB4	
16	4.7	7.5	9.2	24 DC	2	3RA2416-8XF31-1BB4	2	3RA2416-8XF31-2BB4	
25	5.5	11	11	24 DC	2	3RA2417-8XF31-1BB4	2	3RA2417-8XF31-2BB4	
For IO-Link connection									
12	3.3	5.5	9.2	24 DC	2	3RA2415-8XE31-1BB4	2	3RA2415-8XE31-2BB4	
16	4.7	7.5	9.2	24 DC	2	3RA2416-8XE31-1BB4	2	3RA2416-8XE31-2BB4	
25	5.5	11	11	24 DC	2	3RA2417-8XE31-1BB4	2	3RA2417-8XE31-2BB4	
For AS-Interface connection									
12	3.3	5.5	9.2	24 DC	5	3RA2415-8XH31-1BB4	2	3RA2415-8XH31-2BB4	
16	4.7	7.5	9.2	24 DC	2	3RA2416-8XH31-1BB4	5	3RA2416-8XH31-2BB4	
25	5.5	11	11	24 DC	2	3RA2417-8XH31-1BB4	2	3RA2417-8XH31-2BB4	

Representation of the complete contactor assemblies for star-delta (wye-delta) starting with optionally mountable accessories, see page 3/162.

Switching Devices – Contactors and Contactor Assemblies – for Switching Motors

Contactor Assemblies for Star-Delta (Wye-Delta) Starting

SIRIUS 3RA24 contactor assemblies for star-delta (wye-delta) starting, up to 90 kW

IE3/IE4 ready

Fully wired and tested contactor assemblies for star-delta (wye-delta) starting · Size S0-S0-S0 · Up to 22 kW
 AC operation  or DC operation 



PU (UNIT, SET, M) = 1
 PS* = 1 unit
 PG = 41B



3RA242.-8XF32-1A.2

3RA242.-8XE32-1BB4

3RA242.-8XF32-2A.2

Rated data AC-3				Rated control supply voltage U_s	SD	Screw terminals 		Spring-loaded terminals 		
Operational current I_e up to 400 V	Rating of three-phase motors at 50 Hz and					Article No.	Price per PU	Article No.	Price per PU	
	A	230 V	400 V	690 V	kW					kW
AC operation, 50/60 Hz										
25	7.1	11	19	24 AC	2	3RA2423-8XF32-1AC2	2	3RA2423-8XF32-2AC2		
				110 AC	2	3RA2423-8XF32-1AG2	5	3RA2423-8XF32-2AG2		
				230 AC	5	3RA2423-8XF32-1AL2	5	3RA2423-8XF32-2AL2		
32/40	11.4	15/18.5	19	24 AC	2	3RA2425-8XF32-1AC2	2	3RA2425-8XF32-2AC2		
				110 AC	2	3RA2425-8XF32-1AG2	5	3RA2425-8XF32-2AG2		
				230 AC	5	3RA2425-8XF32-1AL2	5	3RA2425-8XF32-2AL2		
50	--	22	19	24 AC	2	3RA2426-8XF32-1AC2	5	3RA2426-8XF32-2AC2		
				110 AC	2	3RA2426-8XF32-1AG2	5	3RA2426-8XF32-2AG2		
				230 AC	5	3RA2426-8XF32-1AL2	5	3RA2426-8XF32-2AL2		
DC operation										
25	7.1	11	19	24 DC	2	3RA2423-8XF32-1BB4	2	3RA2423-8XF32-2BB4		
32/40	11.4	15/18.5	19	24 DC	2	3RA2425-8XF32-1BB4	2	3RA2425-8XF32-2BB4		
50	--	22	19	24 DC	2	3RA2426-8XF32-1BB4	2	3RA2426-8XF32-2BB4		
For IO-Link connection										
25	7.1	11	19	24 DC	2	3RA2423-8XE32-1BB4	5	3RA2423-8XE32-2BB4		
32/40	11.4	15/18.5	19	24 DC	2	3RA2425-8XE32-1BB4	5	3RA2425-8XE32-2BB4		
50	--	22	19	24 DC	2	3RA2426-8XE32-1BB4	5	3RA2426-8XE32-2BB4		
For AS-Interface connection										
25	7.1	11	19	24 DC	5	3RA2423-8XH32-1BB4	2	3RA2423-8XH32-2BB4		
32/40	11.4	15/18.5	19	24 DC	5	3RA2425-8XH32-1BB4	5	3RA2425-8XH32-2BB4		
50	--	22	19	24 DC	2	3RA2426-8XH32-1BB4	5	3RA2426-8XH32-2BB4		

Representation of the complete contactor assemblies for star-delta (wye-delta) starting with optionally mountable accessories, see page 3/163.

Switching Devices – Contactors and Contactor Assemblies – for Switching Motors

Contactor Assemblies for Star-Delta (Wye-Delta) Starting

IE3/IE4 ready SIRIUS 3RA24 contactor assemblies for star-delta (wye-delta) starting, up to 90 kW

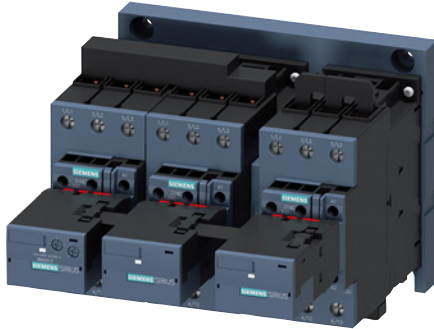

Fully wired and tested contactor assemblies for star-delta (wye-delta) starting · Size S2-S2-S0 · Up to 45 kW and S2-S2-S2 · 55 kW · AC operation , AC/DC operation  or DC operation 

PU (UNIT, SET, M) = 1
 PS* = 1 unit
 PG = 41B



3RA2437-8XF32-1A.2

3RA2434-8XE32-1NB3

Rated data AC-3					SD	Screw terminals 		SD	Spring-loaded terminals 	
Operational current I_e up to 400 V	Rating of three-phase motors at 50 Hz and			Rated control supply voltage U_s		Article No.	Price per PU		Article No.	Price per PU
A	230 V	400 V	690 V	V	d					
AC operation, 50/60 Hz										
50/65	19.6	22/30	34	24 AC	5	3RA2434-8XF32-1AC2		--		
				110 AC	5	3RA2434-8XF32-1AG2		--		
				230 AC	2	3RA2434-8XF32-1AL2		--		
80	25	37	63	24 AC	2	3RA2435-8XF32-1AC2		--		
				110 AC	2	3RA2435-8XF32-1AG2		--		
				230 AC	2	3RA2435-8XF32-1AL2		--		
86	27	45	63	24 AC	2	3RA2436-8XF32-1AC2		--		
				110 AC	2	3RA2436-8XF32-1AG2		--		
				230 AC	2	3RA2436-8XF32-1AL2		--		
115	37	55	93	24 AC	5	3RA2437-8XF32-1AC2		--		
				110 AC	5	3RA2437-8XF32-1AG2		--		
				230 AC	2	3RA2437-8XF32-1AL2		--		
AC/DC operation										
<i>With integrated coil circuit (varistor integrated in electronics at the factory)</i>										
50/65	19.6	22/30	34	24 ... 33 AC/DC	2	3RA2434-8XF32-1NB3		--		
80	25	37	63	24 ... 33 AC/DC	2	3RA2435-8XF32-1NB3		--		
86	27	45	63	24 ... 33 AC/DC	2	3RA2436-8XF32-1NB3		--		
115	37	55	93	24 ... 33 AC/DC	5	3RA2437-8XF32-1NB3		--		
DC operation										
<i>For IO-Link connection</i>										
50/65	19.6	22/30	34	24 DC	5	3RA2434-8XE32-1NB3		--		
80	25	37	63	24 DC	5	3RA2435-8XE32-1NB3		--		
86	27	45	63	24 DC	5	3RA2436-8XE32-1NB3		--		
115	37	55	93	24 DC	5	3RA2437-8XE32-1NB3		--		
<i>For AS-Interface connection</i>										
50/65	19.6	22/30	34	24 DC	5	3RA2434-8XH32-1NB3		--		
80	25	37	63	24 DC	5	3RA2435-8XH32-1NB3		--		
86	27	45	63	24 DC	5	3RA2436-8XH32-1NB3		--		
115	37	55	93	24 DC	5	3RA2437-8XH32-1NB3		--		

Representation of the complete contactor assemblies for star-delta (wye-delta) starting in size S2-S2-S2 with optionally mountable accessories, see page 3/164.

Switching Devices – Contactors and Contactor Assemblies – for Switching Motors

Contactor Assemblies for Star-Delta (Wye-Delta) Starting

SIRIUS 3RA24 contactor assemblies for star-delta (wye-delta) starting, up to 90 kW

IE3/IE4 ready**Fully wired and tested contactor assemblies for star-delta (wye-delta) starting · Size S3-S3-S2 · Up to 90 kW****AC operation** , **AC/DC operation**  or **DC operation** 

PU (UNIT, SET, M) = 1
 PS* = 1 unit
 PG = 41B



3RA244.-8XF32-1A.2

3RA244.-8XE32-1NB3

3RA244.-8XH32-1NB3

Rated data AC-3				Rated control supply voltage U_s		SD	Screw terminals	SD	Spring-loaded terminals	
Operational current I_e up to	Rating of three-phase motors at 50 Hz and			V	d	+	Article No.	Price per PU	Article No.	Price per PU
	400 V	230 V	400 V							
A	kW	kW	kW	V	d					
AC operation, 50/60 Hz										
115	30	55	90	24 AC	X		3RA2444-8XF32-1AC2	--		
				110 AC	X		3RA2444-8XF32-1AG2	--		
				230 AC	X		3RA2444-8XF32-1AL2	--		
150	37	75	110	24 AC	X		3RA2445-8XF32-1AC2	--		
				110 AC	X		3RA2445-8XF32-1AG2	--		
				230 AC	X		3RA2445-8XF32-1AL2	--		
160	45	90	132	24 AC	X		3RA2446-8XF32-1AC2	--		
				110 AC	X		3RA2446-8XF32-1AG2	--		
				230 AC	X		3RA2446-8XF32-1AL2	--		
AC/DC operation										
With integrated coil circuit (varistor integrated in electronics at the factory)										
115	30	55	90	24 ... 33 AC/DC	X		3RA2444-8XF32-1NB3	--		
150	37	75	110	24 ... 33 AC/DC	X		3RA2445-8XF32-1NB3	--		
160	45	90	132	24 ... 33 AC/DC	X		3RA2446-8XF32-1NB3	--		
DC operation										
For IO-Link connection										
115	30	55	90	24 DC	X		3RA2444-8XE32-1NB3	--		
150	37	75	110	24 DC	X		3RA2445-8XE32-1NB3	--		
160	45	90	132	24 DC	X		3RA2446-8XE32-1NB3	--		
For AS-Interface connection										
115	30	55	90	24 DC	X		3RA2444-8XH32-1NB3	--		
150	37	75	110	24 DC	X		3RA2445-8XH32-1NB3	--		
160	45	90	132	24 DC	X		3RA2446-8XH32-1NB3	--		

Representation of the complete contactor assemblies for star-delta (wye-delta) starting with optionally mountable accessories, see page 3/165.

Switching Devices – Contactors and Contactor Assemblies – for Switching Motors

Contactor Assemblies for Star-Delta (Wye-Delta) Starting

Contactor assemblies for star-delta (wye-delta) starting consisting of SIRIUS 3RT contactors, up to 500 kW

Overview

The individual parts for the contactor assemblies for star-delta (wye-delta) starting for customer assembly must be ordered separately.

- 3RT contactors: The operating times of the individual 3RT10 contactors are rated in such a way that no overlapping of the contact making and the arcing time between two contactors can occur on reversing, provided they are interlocked by way of their auxiliary switches (NC contact interlock) and the mechanical interlock.
For assemblies with AC operation and 50/60 Hz, a dead interval of 50 ms must be provided when used with voltages over 500 V; a dead interval of 30 ms is recommended for use with voltages up to and including 400 V. These dead times do not apply to assemblies with DC operation.
The operating times of the individual contactors are not affected by the mechanical interlock.
- Mechanical interlock
- Wiring kits: consisting of wiring modules or link rails and star jumpers
- Adapter for the mechanical interlock between S6 and S3
- Base plate

Additional components

- For momentary-contact operation: auxiliary switch (NO contact) for self-locking
- 3RB2 overload relays ([page 7/117 onwards](#)), SIMOCODE pro 3UF7 motor management and control devices ([page 10/16 onwards](#)) or 3RN thermistor motor protection relays ([page 10/155](#)) can be used for overload protection. The overload relay can either be mounted onto the line contactor or separately fitted. It must be set to 0.58 times the rated motor current.
- Optional surge suppression for the S3 contactors; the contactors in sizes S6 to S12 are wired as standard with varistors.

The contactor assemblies for star-delta (wye-delta) starting for customer assembly are designed for standard applications.

Note:

Contactor assemblies for star-delta (wye-delta) starting in special applications such as very heavy starting¹⁾ or star-delta (wye-delta) starting of special motors must be customized. Help with designing such special applications is available from our Technical Support:

<https://support.industry.siemens.com/My/ww/en/requests>

¹⁾ For effective assistance from Technical Support, you must provide the following details:

- Rated motor voltage
- Rated motor current
- Service factor, operating values
- Motor starting current factor
- Starting time
- Ambient temperature

More information

Homepage, see www.siemens.com/sirius

Industry Mall, see www.siemens.com/product?3RA24_3RT

Switching Devices – Contactors and Contactor Assemblies – for Switching Motors

Contactor Assemblies for Star-Delta (Wye-Delta) Starting

Contactor assemblies for star-delta (wye-delta) starting consisting of SIRIUS 3RT contactors, up to 500 kW

Contactor assemblies for star-delta (wye-delta) starting for customer assembly · Size S6-S6-S3 · Up to 160 kW

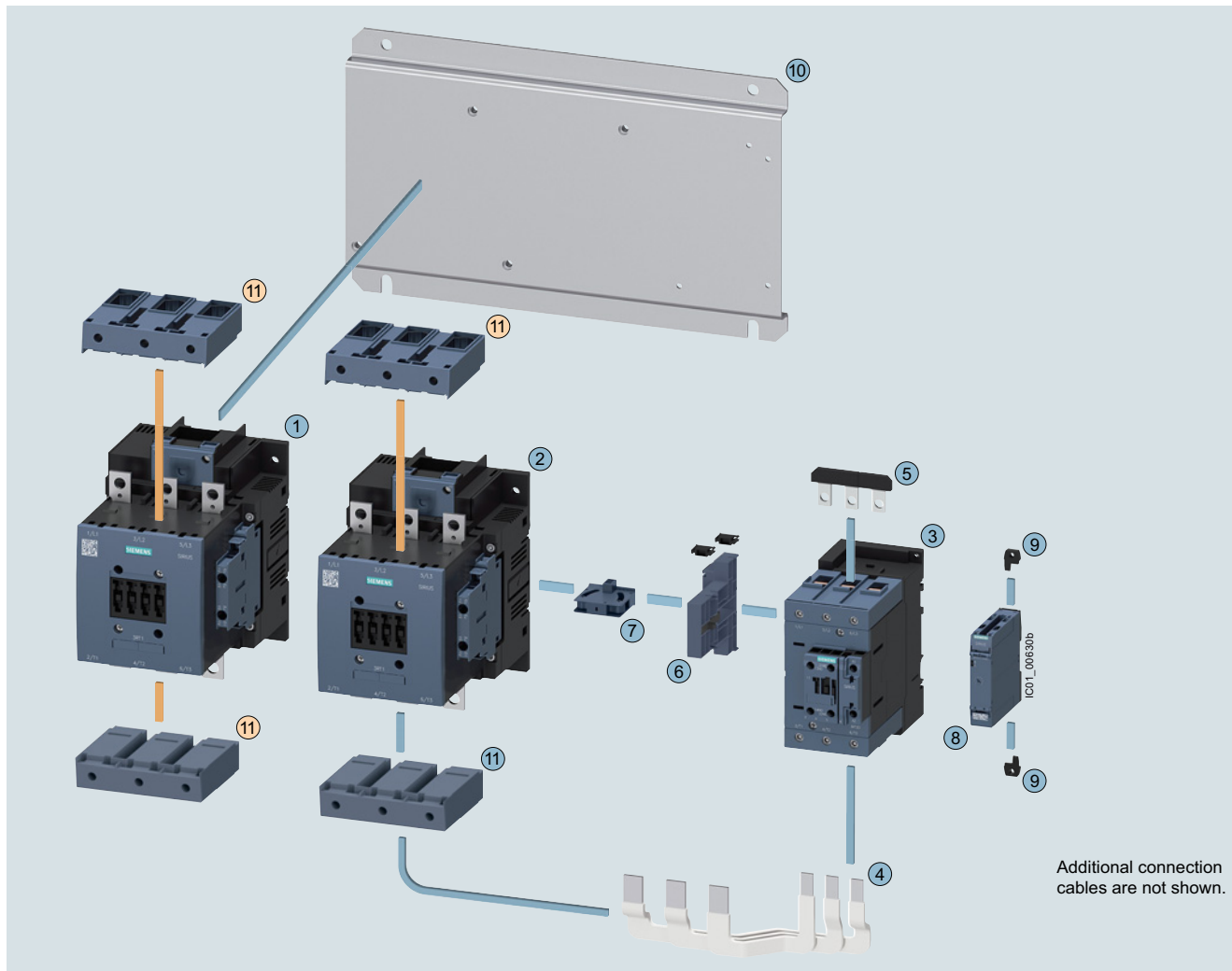

Additional connection cables are not shown.

Mountable accessories (optional)

To be ordered separately	Type	Page
⑪ Box terminal blocks	3RT1955-4G	3/115

Contactor assemblies for star-delta (wye-delta) starting for customer assembly

Individual parts	Type	Page
①②③ Contactors, 110 kW	Q11 3RT1054 Q13 3RT1054 Q12 3RT2045	3/58, 3/66, 3/69 ... 3/72
①②③ Contactors, 132 kW	3RT1055 3RT1055 3RT2046	3/58, 3/66, 3/69 ... 3/72
①②③ Contactors, 160 kW	3RT1056 3RT1056 3RT2047	3/58, 3/66, 3/69 ... 3/72
④ <u>Assembly kit S6-S6-S3 for contactors with box terminals</u> consisting of: Wiring modules, bottom	3RA1953-3G	3/111
⑤ Star jumper S3	3RT1946-4BA31	3/112
⑥ Adapter for the mechanical interlock between S6 and S3 (including two connectors)	3RA1954-2G ¹⁾	3/113
⑦ Mechanical interlock between S6 and S3	3RA1954-2A	3/113
⑧ Timing relay with star-delta (wye-delta) function	3RP257.	10/38
⑨ Push-in lugs for star-delta (wye-delta) timing relays	3ZY1311-0AA00	10/39
⑩ Base plate star-delta (wye-delta)	3RA1952-2E	3/118
⑪ Box terminal block	3RT1955-4G	3/115

¹⁾ The 3RA1954-2G adapter cannot be used in conjunction with 3RT204...-KB coupling contactors, size S3.

Switching Devices – Contactors and Contactor Assemblies – for Switching Motors

Contactor Assemblies for Star-Delta (Wye-Delta) Starting

Contactor assemblies for star-delta (wye-delta) starting consisting of SIRIUS 3RT contactors, up to 500 kW

Contactor assemblies for star-delta (wye-delta) starting for customer assembly · Size S6-S6-S6 · Up to 160 kW

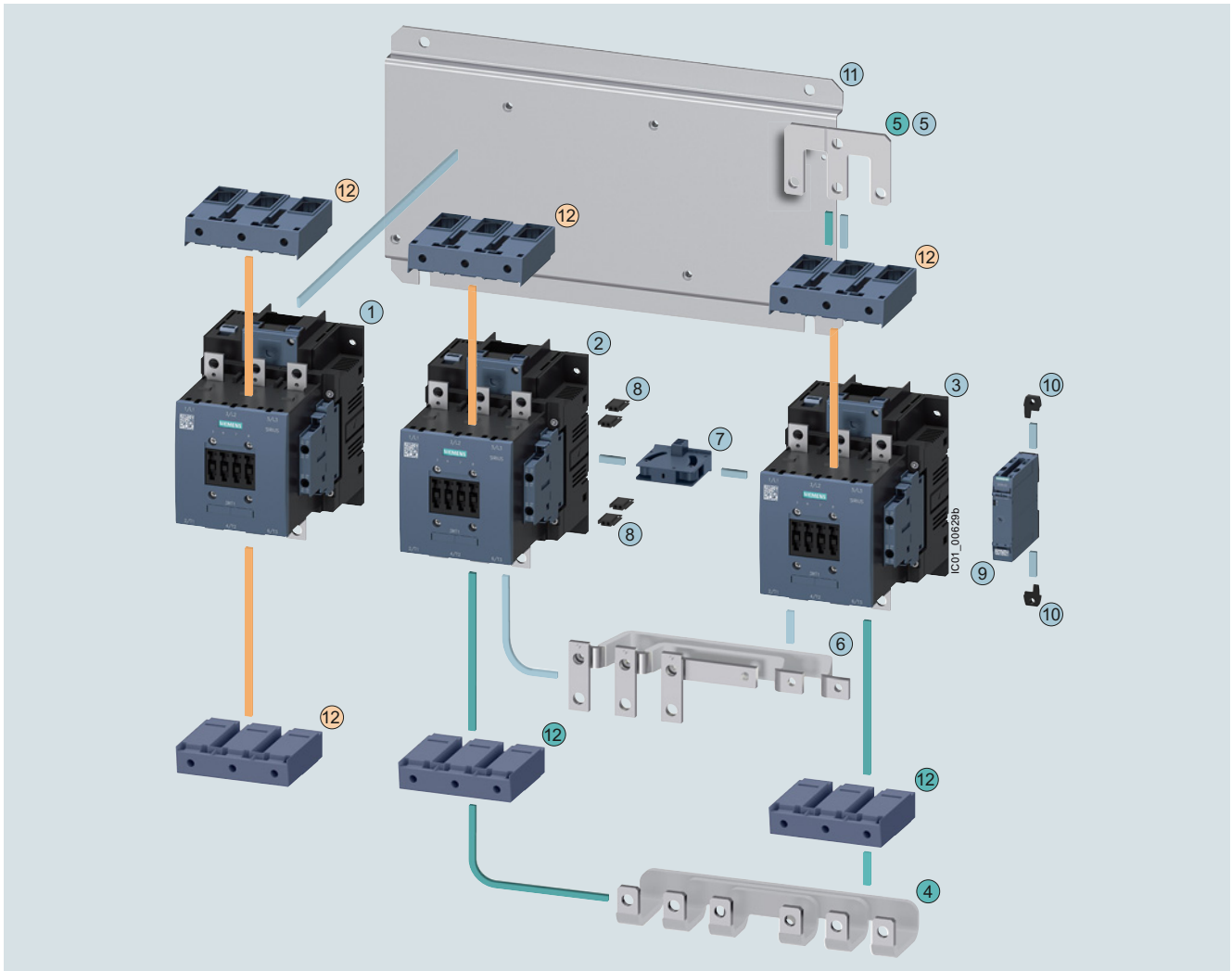

Mountable accessories (optional)

To be ordered separately	Type	Page
12	Box terminal blocks	3/115

Contactor assemblies for star-delta (wye-delta) starting for customer assembly

Individual parts	Type			Page
	Q11	Q13	Q12	
1 2 3	3RT1054	3RT1054	3RT1054	3/70 ... 3/72
1 2 3	3RT1055	3RT1055	3RT1055	3/70 ... 3/72
1 2 3	3RT1056	3RT1056	3RT1056	3/70 ... 3/72
4 5	3RA1953-2B			3/111
4 5				
4				
5				
5 6	3RA1953-2N			3/111
6				
5				
7	3RA1954-2A			3/113
8	3RA1932-2D			3/113
9	3RP257			10/38
10	3ZY1311-0AA00			10/39
11	3RA1952-2F			3/118
12	3RT1955-4G			3/115

Switching Devices – Contactors and Contactor Assemblies – for Switching Motors

Contactor Assemblies for Star-Delta (Wye-Delta) Starting

Contactor assemblies for star-delta (wye-delta) starting consisting of SIRIUS 3RT contactors, up to 500 kW

Contactor assemblies for star-delta (wye-delta) starting for customer assembly · Size S10-S10-S6 · Up to 250 kW

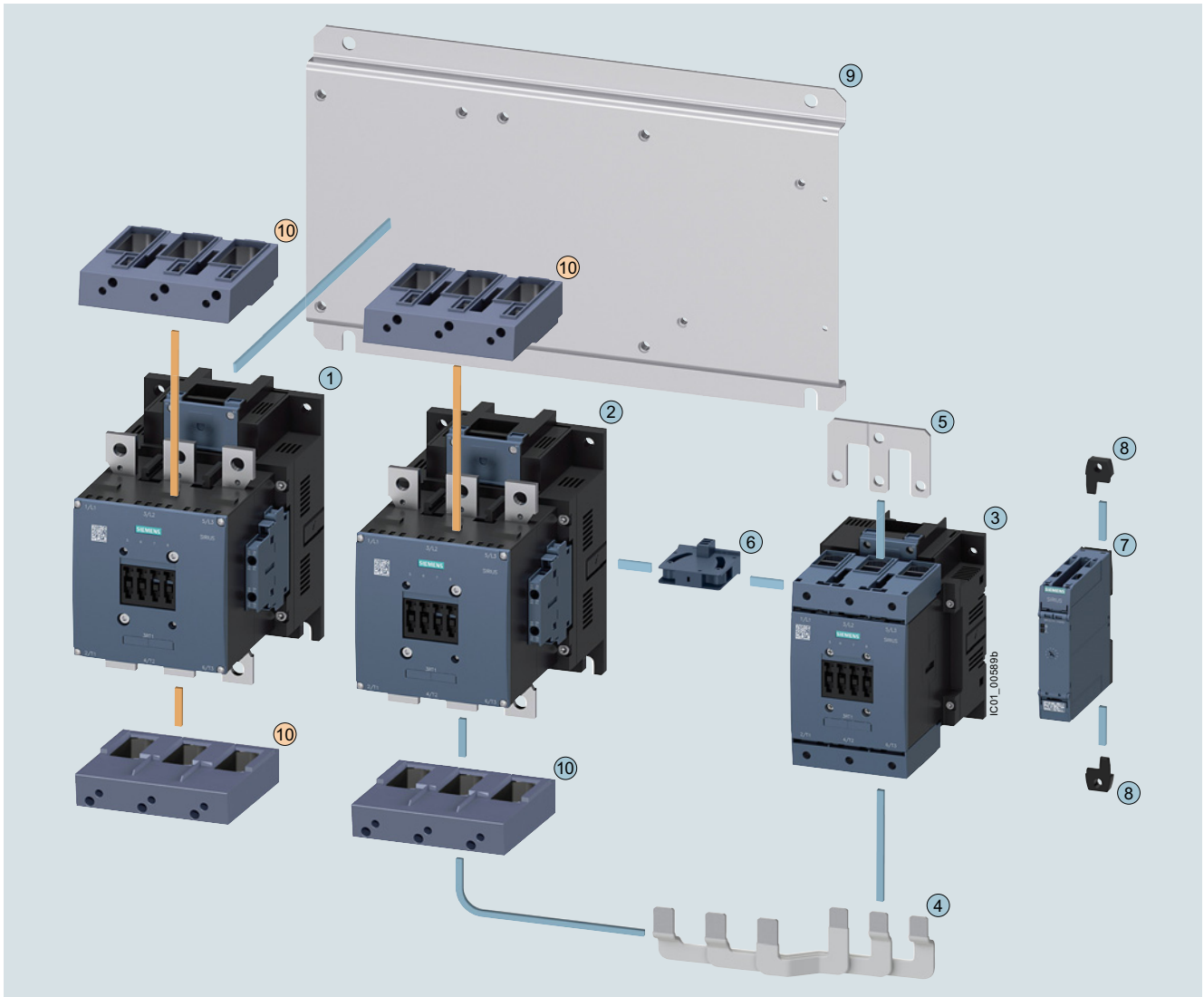

Mountable accessories (optional)

To be ordered separately	Type	Page
⑩ Box terminal blocks	3RT1966-4G	3/115

Contactor assemblies for star-delta (wye-delta) starting for customer assembly

Individual parts	Type			Page
	Q11	Q13	Q12	
①②③ Contactors, 200 kW	3RT1.64	3RT1.64	3RT1054	3/70 ... 3/72, 3/134
①②③ Contactors, 250 kW	3RT1.65	3RT1.65	3RT1055	3/70 ... 3/72, 3/134
④ Assembly kit S10-S10-S6 for contactors with box terminals consisting of: Wiring modules, bottom	3RA1963-3E			3/111
⑤ Star jumper S6	3RT1956-4BA31			3/112
⑥ Mechanical interlock between S10 and S6	3RA1954-2A			3/113
⑦ Timing relay with star-delta (wye-delta) function	3RP257.			10/38
⑧ Push-in lugs for star-delta (wye-delta) timing relays	3ZY1311-0AA00			10/39
⑨ Base plate star-delta (wye-delta)	3RA1962-2E			3/118
⑩ Box terminal block	3RT1966-4G			3/115

Switching Devices – Contactors and Contactor Assemblies – for Switching Motors

Contactor Assemblies for Star-Delta (Wye-Delta) Starting

Contactor assemblies for star-delta (wye-delta) starting consisting of SIRIUS 3RT contactors, up to 500 kW

Contactor assemblies for star-delta (wye-delta) starting for customer assembly · Size S10-S10-S10 · Up to 250 kW

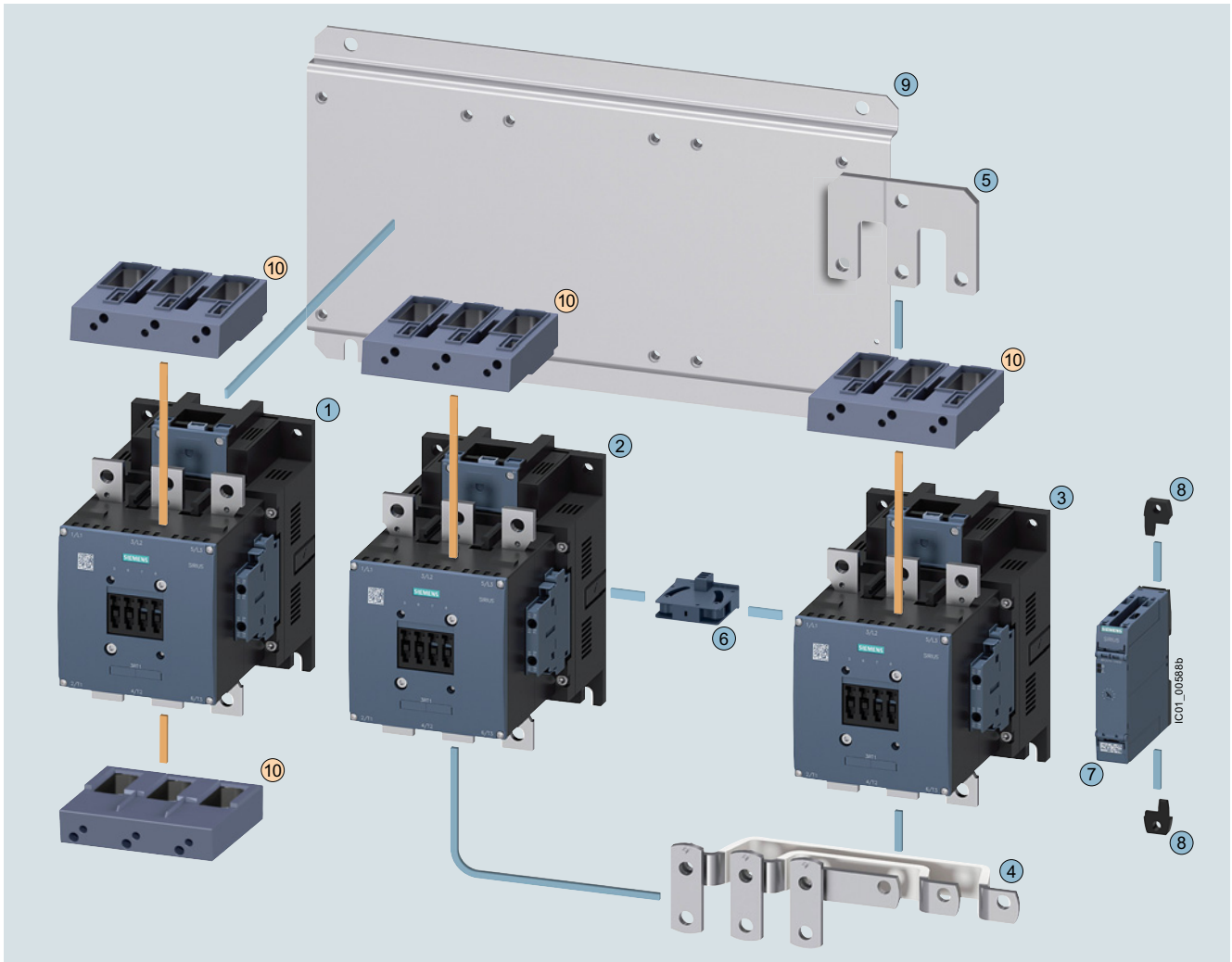

Mountable accessories (optional)

To be ordered separately	Type	Page
⑩ Box terminal blocks	3RT1966-4G	3/115

Contactor assemblies for star-delta (wye-delta) starting for customer assembly

Individual parts	Type			Page
	Q11	Q13	Q12	
①②③ Contactors, 200 kW	3RT1.64	3RT1.64	3RT1.64	3/70 ... 3/72, 3/134
①②③ Contactors, 250 kW	3RT1.65	3RT1.65	3RT1.65	3/70 ... 3/72, 3/134
④⑤ Assembly kit S10-S10-S10 for contactors without box terminals consisting of:	3RA1963-2B			3/111
④ Link rails, bottom				
⑤ Star jumper S10				
⑥ Mechanical interlock	3RA1954-2A			3/113
⑦ Timing relay with star-delta (wye-delta) function	3RP257.			10/38
⑧ Push-in lugs for star-delta (wye-delta) timing relays	3ZY1311-0AA00			10/39
⑨ Base plate star-delta (wye-delta)	3RA1962-2F			3/118

Switching Devices – Contactors and Contactor Assemblies – for Switching Motors

Contactor Assemblies for Star-Delta (Wye-Delta) Starting

Contactor assemblies for star-delta (wye-delta) starting consisting of SIRIUS 3RT contactors, up to 500 kW

Contactor assemblies for star-delta (wye-delta) starting for customer assembly · Size S12-S12-S10 · Up to 500 kW

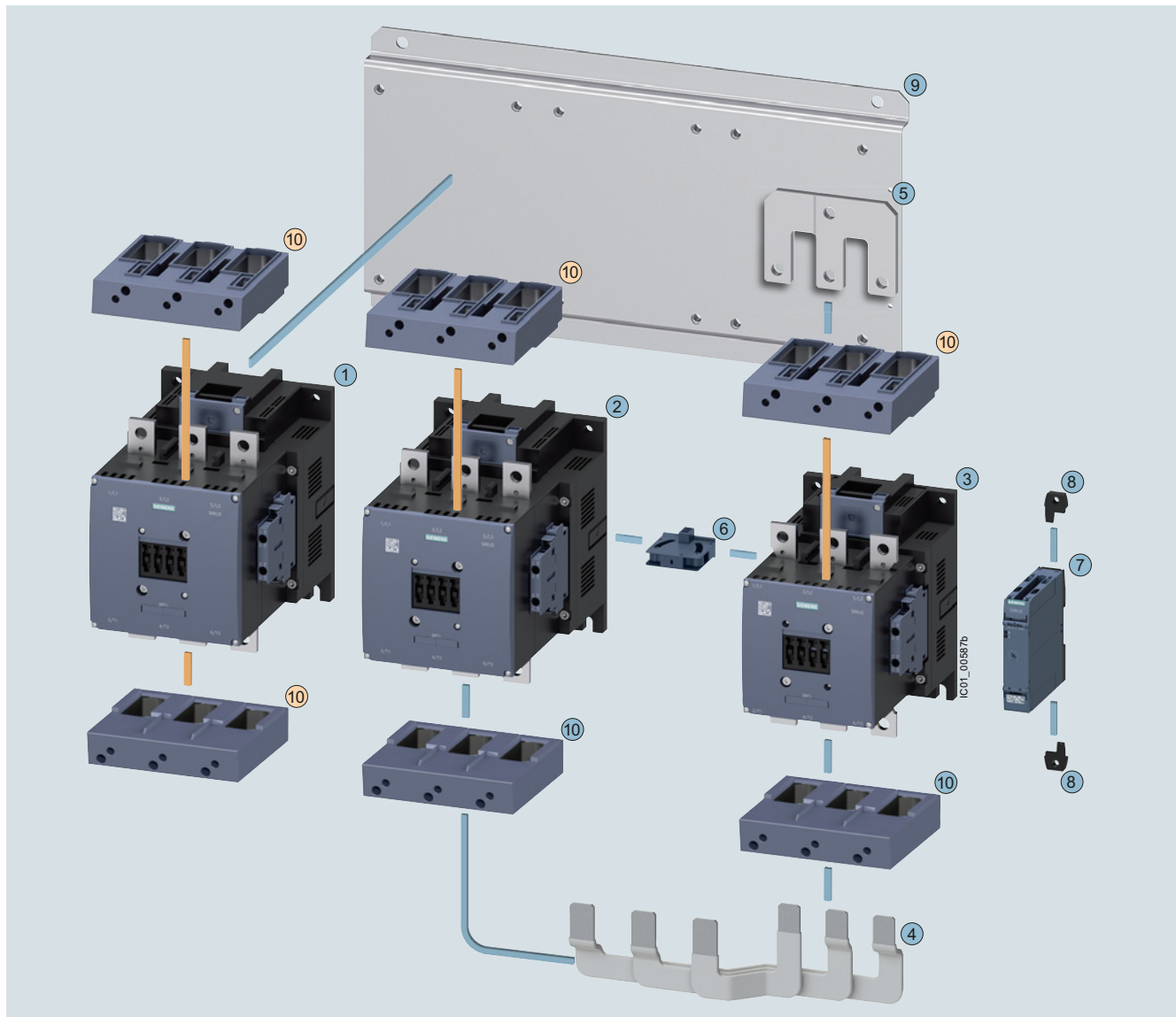

Mountable accessories (optional)

To be ordered separately	Type	Page
⑩ Box terminal blocks	3RT1966-4G	3/115

Contactor assemblies for star-delta (wye-delta) starting for customer assembly

Individual parts	Type			Page
	Q11	Q13	Q12	
①②③ Contactors, 355 kW	3RT1.75	3RT1.75	3RT1.64	3/70 ... 3/72, 3/134
①②③ Contactors, 400 kW	3RT1.75	3RT1.75	3RT1.65	3/70 ... 3/72, 3/134
①②③ Contactors, 500 kW	3RT1.76	3RT1.76	3RT1.66	3/70 ... 3/72, 3/134
④ Assembly kit S12-S12-S10 for contactors with box terminals consisting of: Wiring modules, bottom	3RA1973-3E			3/111
⑤ Star jumper S10	3RT1966-4BA31			3/112
⑥ Mechanical interlock between S12 and S10	3RA1954-2A			3/113
⑦ Timing relay with star-delta (wye-delta) function	3RP257.			10/38
⑧ Push-in lugs for star-delta (wye-delta) timing relays	3ZY1311-0AA00			10/39
⑨ Base plate star-delta (wye-delta)	3RA1972-2E			3/118
⑩ Box terminal blocks	3RT1966-4G			3/115

Switching Devices – Contactors and Contactor Assemblies – for Switching Motors

Contactor Assemblies for Star-Delta (Wye-Delta) Starting

Contactor assemblies for star-delta (wye-delta) starting consisting of SIRIUS 3RT contactors, up to 500 kW

Contactor assemblies for star-delta (wye-delta) starting for customer assembly · Size S12-S12-S12 · Up to 500 kW

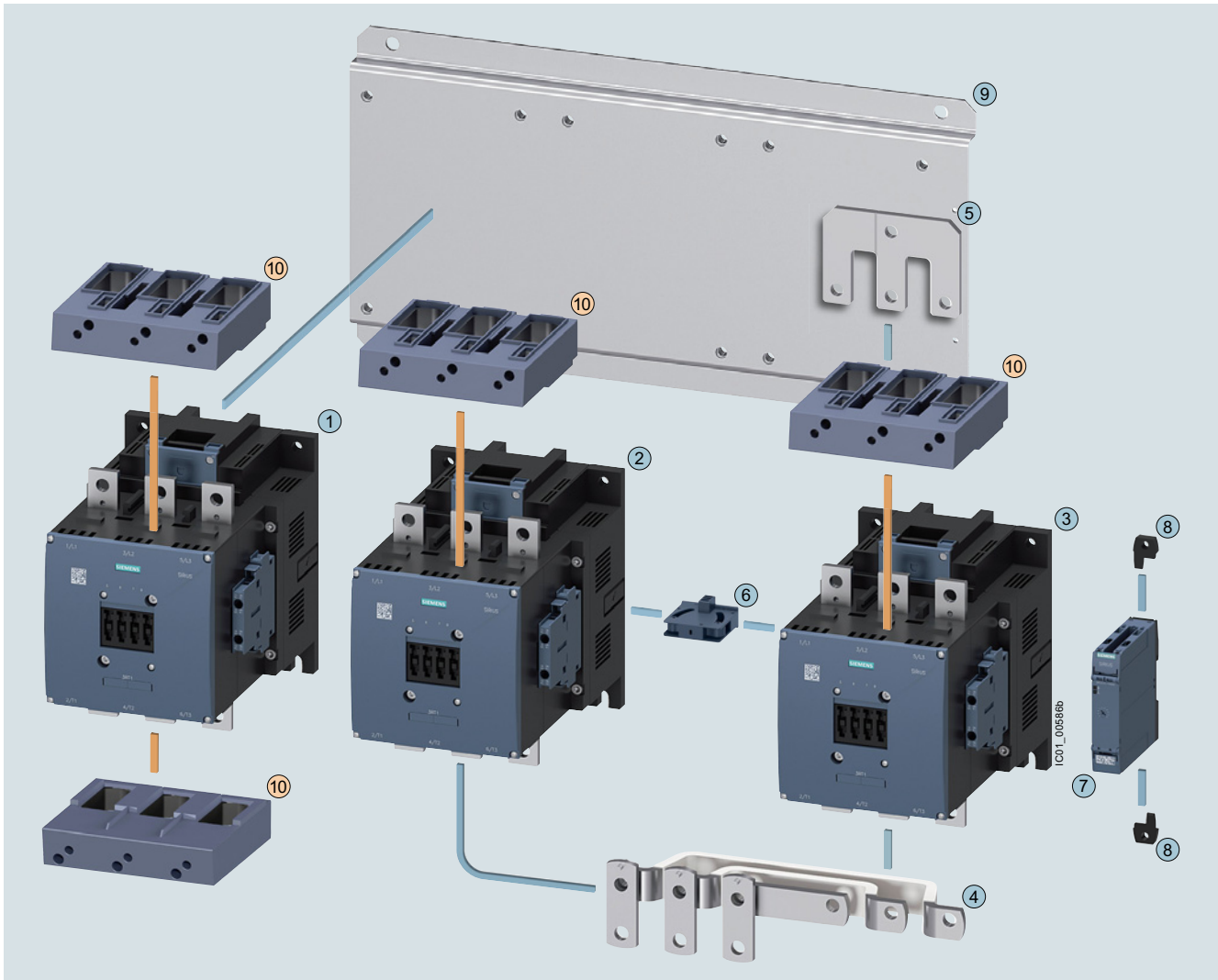

Mountable accessories (optional)

To be ordered separately	Type	Page
⑩	Box terminal blocks	3/115

Contactor assemblies for star-delta (wye-delta) starting for customer assembly

Individual parts	Type			Page
	Q11	Q13	Q12	
①②③	3RT1.75	3RT1.75	3RT1.75	3/70 ... 3/72, 3/134
①②③	3RT1.76	3RT1.76	3RT1.76	3/70 ... 3/72, 3/134
④⑤	3RA1973-2B			3/111
Assembly kit S12-S12-S12 for contactors without box terminals consisting of:				
④	Link rails, bottom			
⑤	Star jumper S12			
⑥	Mechanical interlock	3RA1954-2A		3/113
⑦	Timing relay with star-delta (wye-delta) function	3RP257.		10/38
⑧	Push-in lugs for star-delta (wye-delta) timing relays	3ZY1311-0AA00		10/39
⑨	Base plate star-delta (wye-delta)	3RA1972-2F		3/118

Switching Devices – Contactors and Contactor Assemblies – for Switching Motors

Notes

3